

CATALOGUE GÉNÉRAL

2021-2022



DISTRIMO

la marque de distribution de



Electroportatifs Mobilier

Outillages et consommables

EPI

PIRL et Outils d'accès

Signalétique

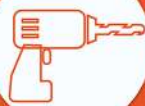

CONSOMMABLE ET MATERIEL	3	MALAXAGE MACHINE/ACCESSOIRE	175
VISSERIE CLOUTERIE BOULONNERIE	3	MEULAGE DECOUPAGE MACHINE	176
CHEVILLAGE ANCRAGE	8	MEULAGE DECOUPAGE CONSOMMABLE	179
COUPE FEU	46	PERCAGE MACHINE	185
ISOLANT	52	PERCAGE ACCESSOIRE	187
SCELLEMENT INJECTION	53	PERCAGE CONSOMMABLE	190
SUPPORTAGE	75	PERFO BURINAGE PIQUAGE MACHINE	199
ABRASIF	83	PERFO BURINAGE PIQUAGE ACCESSOIRE	204
COLLE ET ADHESIF	84	PERFO BURINAGE PIQUAGE CONSOMMABLE	211
LUBRIF HUILE GRAISSE AERO GAZ	86	PONCAGE SURFACAGE MACHINE	241
ACCESSOIRE MARQUAGE	90	PONCAGE SURFACAGE ACCESSOIRE	244
BOMBE DE PEINTURE	92	PONCAGE SURFACAGE CONSOMMABLE	246
POUDRE A TRACER	93	RAINURAGE MACHINE/CONSOMMABLE	254
CONSO ET MAT PLOMBERIE SOUDURE	94	RIVETTEUSE	255
CONSO ET MAT ELECTRICITE	101	SERTISSAGE MACHINE/ACCESSOIRE	256
CONSO ET MAT COFFRAGE BANCHAGE	115	SCIAGE RUBAN MACHINE/CONSOMMABLE	258
CONSO ET MAT LEVAGE	117	SCIAGE CIRCULAIRE MACHINE	260
POLYANE PROTECTION ET SAC	129	SCIAGE CIRCULAIRE ACCESSOIRE	263
ELECTROPORTATIF	131	SCIAGE CIRCULAIRE CONSOMMABLE	266
ASPIRATION MACHINE	131	SCIAGE SABRE MACHINE	272
ASPIRATION ACCESSOIRE	134	SCIAGE SABRE ACCESSOIRE	273
ASPIRATION CONSOMMABLE	136	SCIAGE SABRE CONSOMMABLE	274
BOULONNAGE MACHINE	141	SCIAGE A ONGLET MACHINE/ACCESSOIRE	279
BOULONNAGE ACCESSOIRE	142	SCIAGE SAUTEUSE MACHINE	281
BOULONNAGE CONSOMMABLE	144	SCIAGE SAUTEUSE CONSOMMABLE	282
CAROTTAGE MACHINE	150	SOUFFLAGE MACHINE	290
CAROTTAGE ACCESSOIRE	151	TRONCONNAGE MACHINE	291
CAROTTAGE CONSOMMABLE	159	TRONCONNAGE MEULAGE ACCESSOIRE	294
CERCLAGE	160	TRONCONNAGE CONSOMMABLE	298
CISAILLAGE MACHINE	161	USINAGE MACHINE	305
CISAILLAGE ACCESSOIRE/CONSOMMABLE	162	USINAGE ACCESSOIRE	310
CLOUAGE MACHINE	164	USINAGE CONSOMMABLE	321
CLOUAGE ACCESSOIRE/CONSOMMABLE	165	VISSAGE MACHINE	327
DECOUPAGE MACHINE	166	VISSAGE ACCESSOIRE	329
DECOUPAGE ACCESSOIRES ET CONSOMMABLES	168	VISSAGE CONSOMMABLE	335
FINITION SILICONE MACHINE/ACCESSOIRE	170	PRESTATION	343
LIGATURAGE MACHINE	171	PRESTATION	343
LIGATURAGE ACCESSOIRE	173	ENTRETIEN	345
LIGATURAGE CONSOMMABLE	174	DEPOLLUTION	345

TABLE DES MATIÈRES

AMIANTE	349
POUBELLE ET SAC	352
OUTIL A MAIN DE NETTOYAGE	353
MACHINE DE NETTOYAGE	357
PRODUIT DE NETTOYAGE	359
HYGIENE	363
EQUIPEMENT PROTEC INDIVIDUELLE	365
CASQUE	365
CASQUETTE	369
ACCESSOIRE CASQUE	371
PROTECTION AUDITIVE	382
LUNETTES & MASQUES	385
ACCESSOIRES LUNETTES	387
LUNETTES DE SECURITE A LA VUE	394
VOIE RESPIRATOIRE	395
AMIANTE ET PLOMB	400
COMBINAISON	404
GANT	406
ACCESSOIRE GANT	416
GILET	417
TEE-SHIRT & POLO	426
SWEAT & POLAIRE	434
VESTE	436
PARKA	439
PANTALON	447
SOUS-VETEMENTS	454
PLUIE	457
ACCESSOIRE CORPS	460
CHAUSSURE	462
ACCESSOIRE PIED	469
ACCESSOIRE TRAVAIL EN HAUTEUR	472
CORDAGE	479
HARNAIS	486
SOUDEUR	490
ELAGUEUR	491
KIT	493
SAC	494
EQUIPEMENT	497
SANTE	501

INSTALLATION CHANTIER	505
DEMARRAGE DE CHANTIER	505
MATERIEL D'EMBALLAGE	508
CORDAGE CERCLAGE	514
MOBILIER ET BUNGALOW	516
VAISSELLE JETABLE ET CONSO	527
ELECTROMENAGER	528
SECURITE	531
VEHICULE	534
RALLONGE ELEC ENROUL MULTIPRIS	535
POMPE ELECTRIQUE	536
LAMPE ET PROJECTEUR	538
AMPOULE ET TUBE	542
PILE ET CHARGEUR	543
POSTES ÉMETTEUR RÉCEPTEUR	545
OUTIL ACCES TRAVAIL EN HAUTEUR	547
PLATEFORME DE TRAVAIL PIR	547
ACCESSOIRE PLATEFORME DE TRAVAIL PIR	550
OUTIL D'ACCÈS	554
OUTIL ECHAFAUDAGE	557
ACCESSOIRE ECHAFAUDAGE	559
OUTILLAGE	561
OUTIL ELECTRICIEN	561
OUTIL MACON FINISSEUR	584
OUTIL FERRAILLEUR	591
OUTIL COFFREUR BANCHEUR	594
OUTIL MENUISIER CHARPENTIER	598
OUTIL TERRASSIER	602
OUTIL PEINTRE ET PLATRIER	605
OUTIL PLOMBIER	609
OUTIL SOUDEUR	611
CLE ET CLIQUET	613
DOUILLE	622
COFFRE ET COMPOSITION	625
PINCE ET TENAILLE	628
TOURNEVIS	630
ETAU ET SERRE JOINT	632
LIME ET RAPE	633
MARTELLERIE	635

OUTIL MESURE CONTROLE TRACAGE	640
ACCESSOIRE OUTIL MESURE CONTROLE TRACAGE	659
PULVERISATEUR JERRICAN AUTRE	675
MANUTENTION	680
LABORATOIRE BETON	685
VIBRATION	687
TABLE ET TRETEAU	689
SUPPORT POUR TRAVAUX A GENOUX	691
SIGNALETIQUE	693
DRAPEAU	693
AUTOCOLLANT ENTITE	694
AUTOCOLLANT CASQUE	696
AUTOCOLLANT AUTRE	698
PANNEAU ENTITE	699
PANNEAU AFFICHAGE	701
PANNEAU AUTRE	703
BALISAGE	711
ETIQUETTE	715
WIZOM	716

CLOU A MAIN X-HN

HILTI

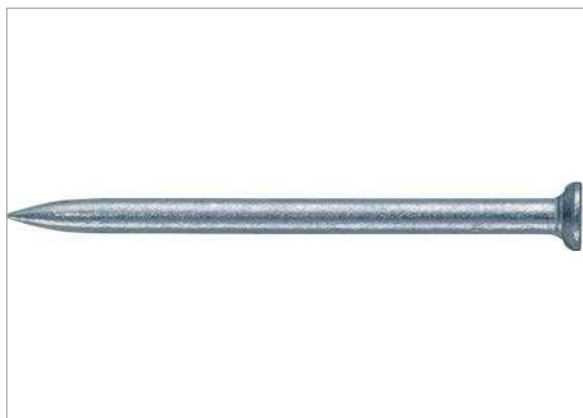

Boîte de 1 kg - Clous à main pour béton - Longueur / diamètre

RÉF. ART.	DESCRIPTION	LONGUEUR	REFERENCE FABRICANT
CO001016	100/4	L 100 MM	274952
CO001021	40/3	L 40 MM	274946
CO001023	50/4	L 50 MM	388328
CO001024	60/4	L 60 MM	274948

VIS AUTOTARAUDEUSE

HILTI



Vis autotaraudeuse, rondelle 16 mm (acier inoxydable)

RÉF. ART.	DESCRIPTION	LONGUEUR	DIAMETRE	REFERENCE FABRICANT
CO015152	S-MP53S 6,5X38 LOT DE 250	L 38 MM	D 06,5 MM	80451
CO009442	S-MP53S 6,5X50 BOITE DE 250	L 50 MM	D 06,5 MM	80337
CO009044	S-MP63S 6,5X38 EN BOITE DE 250	L 38 MM	D 06,5 MM	285220

VIS A BOIS S-WD21Z

HILTI



Boîte de 500 Vis pour toiture plate sur support bois, bride intégrée (acier au carbone)

RÉF. ART.	DESCRIPTION	LONGUEUR	DIAMETRE	REFERENCE FABRICANT
CO004599	S-WD21Z 6,5X64	L 64 MM	D 06,5 MM	259199

VIS A OREILLE S-WD11C

HILTI



BOITE DE 200 Vis à ailettes autoperceuse (acier au carbone)

RÉF. ART.	DESCRIPTION	LONGUEUR	DIAMETRE	REFERENCE FABRICANT
CO009952	S-WD11C 4,2x25	L 25 MM	D 04,2 MM	283635

VIS AUTOPERCEUSE



Autoperceuse sans rondelle - pour coutrage de plateaux et fixation de cassettes

RÉF. ART.	DESCRIPTION	LON- GUEUR	DIAMETRE	REFERENCE FAB- RICANT
CO004602	EN BOITE DE 1000	L 13 MM	D 04,2 MM	224500
CO008951	EN BOITE DE 500	L 25 MM	D 05,5 MM	413408
CO009134	EN BOITE DE 250	L 50 MM	D 06,3 MM	413425
CO010511	EN BOITE DE 500	L 22 MM	D 05,5 MM	413416
CO009441		L 32 MM	D 06,3 MM	413424
CO010510	EN BOITE DE 250	L 40 MM	D 05,5 MM	2054483
CO009217	EN BOITE DE 100	L 65 MM	D 05,5 MM	2054485
CO009797	EN BOITE DE 500	L 25 MM	D 05,5 MM	234588
CO009066		L 22 MM	D 06,3 MM	413430
CO009204	EN BOITE DE 250	L 40 MM	D 05,5 MM	2054488
CO009230	LES 500, ET PLUS PAR 2000	L 19 MM	D 04,8 MM	219032
CO009179	RAL9010 BOITE DE 250	L 38 MM	D 04,8 MM	258790
CO010639	HEX EN BOITE DE 750	L 13 MM	D 04 MM	406471
CO004605	EN BT DE 1000	L 13 MM	D 04 MM	406473
CO004606	EN BOITE DE 1000	L 20 MM	D 04,8 MM	385448
CO004607	EN BOITE DE 250	L 20 MM	D 04,8 MM	385450

VIS PLATRE



Vis pour ossature métallique intérieure (autoperceuse/rondelle)

RÉF. ART.	DESCRIPTION	LON- GUEUR	DIAMETRE	REFERENCE FABRICANT
CO009701	S-DD03Z 4.2X13 BOITE DE 1000	L 13 MM	D 04,2 MM	386638
CO004769	S-DD03Z 4.2X25 BOITE DE 1000		D 04,2 MM	386639
CO008952	S-DS01B 3.5X25 BOITE DE 10000	L 25 MM	D 03,5 MM	2007245
CO009128	S-DS01B 3.5X25 M EN BANDE - BT DE 10000	L 25 MM	D 03,5 MM	2007779
CO018636	S-DS01B 3.5X25 M1 BOITE DE 1000		D 03,5 MM	2134608
CO010417	S-DS01B 3.5X35 M EN BANDE (BT DE 10000)	L 35 MM	D 03,5 MM	2007780
CO009783	S-DS04B 5.5X38 BOITE DE 750	L 38 MM	D 05,5 MM	2007737

POINTE ATP - STD



RÉF. ART.	LONGUEUR
CO005870	L 100 MM
CO005871	L 110 MM
CO005865	L 35 MM
CO005866	L 55 MM
CO005867	L 70 MM
CO005868	L 80 MM
CO005869	L 90 MM

photos non contractuelles

POINTE BÉTON STRIÉE GALVANISÉE



RÉF. ART.	LONGUEUR	DIAMETRE
CO005751	L 20 MM	D 2,7 MM
CO005744	L 30 MM	D 3,5 MM
CO005745	L 40 MM	D 3,5 MM
CO005746	L 50 MM	D 3,5 MM
CO005747	L 60 MM	D 3,5 MM
CO005748	L 70 MM	D 3,5 MM
CO005749	L 80 MM	D 3,5 MM
CO005750	L 80 MM	D 3,5 MM

POINTE TH STD CLAIR



RÉF. ART.	DESCRIPTION
CO003679	L.35MM

RIVETS POP TP



RÉF. ART.	DESCRIPTION
CO003903	D.4MM L.18MM BOITE DE 500

MANUCLOU MC2



CLOUEUR A MAIN POINTE

RÉF. ART.	DIAMETRE	REFERENCE FABRICANT
CO006244	D 02,5 MM	13240

photos non contractuelles

POINTES MC2-20



MANUCLOU SPIT MC2

RÉF. ART.	DESCRIPTION	LONGUEUR	DIAMETRE	REFERENCE FABRI-CANT
CO006336	MC2-20	L 20 MM	D 02,5 MM	37630

POINTE CP



POUR FIXATION DANS BETON AU MARTEAU

RÉF. ART.	DESCRIPTION	LONGUEUR	REFERENCE FABRI-CANT
CO006351	25 EN 2 KG jusqu'à épauement	L 25 MM	41800
CO006352	30 EN 2 KG SPIT	L 30 MM	41810
CO006353	40 EN 2 KG SPIT	L 40 MM	41820
CO006354	50 EN 2 KG SPIT	L 50 MM	41830
CO006355	60 EN 2 KG SPIT	L 60 MM	41840
CO006356	70 EN 2 KG SPIT	L 70 MM	41850

TAPCON LDT



RÉF. ART.	DESCRIPTION	LON-GUEUR	EPAIS-SEUR	DIAMETRE	REFERENCE FABRICANT
CO010730	6X100/65-45 T.HEX.	L 100 MM	Ep 65 MM	D 06 MM	58732
CO010731	6X80/45-25 T.HEX.	L 80 MM	Ep 45 MM	D 06 MM	58731
CO010696	6X50/15 T.HEX.	L 50 MM	Ep 15 MM	D 06 MM	58730
CO010728	6X40/5 T.HEX.	L 40 MM	Ep 05 MM	D 06 MM	58729

TAPCON PAN



RÉF. ART.	DESCRIPTION	LON-GUEUR	EPAIS-SEUR	DIAMETRE	REFERENCE FABRICANT
CO010729	5X40/5 T.PLATE	L 40 MM	Ep 05 MM	D 05 MM	58779
CO010717	6X40/5 T.PLATE T17	L 40 MM	Ep 05 MM	D 06 MM	58783
CO010718	6X60/25-5 T.PLATE T17	L 60 MM	Ep 25 MM	D 06 MM	58784

photos non contractuelles

TAPCON XTREM CSK



RÉF. ART.	DESCRIPTION	LON- GUEUR	DIAMETRE	REFERENCE FABRICANT
CO010725	8X80/35-15 T.FRAIS. A4	L 80 MM	Ep 35 MM D 08 MM	58814

TAPCON XTREM LDT



RÉF. ART.	DESCRIPTION	LON- GUEUR	DIAME- TRE	REFERENCE FABRICANT
CO010719	10X100/45-15 T.HEX.	L 100 MM	Ep 45 MM D 10 MM	58743
CO010720	10X120/65-35 T.HEX.	L 120 MM	Ep 65 MM D 10 MM	58744
CO010721	10X140/85-55 T.HEX.	L 140 MM	Ep 85 MM D 10 MM	58745
CO010722	10X160/105-75 T.HEX.	L 160 MM	Ep 105 MM D 10 MM	58746
CO010723	LDT 10X90/35-5 T.HEX.	L 90 MM	Ep 35 MM D 10 MM	58742
CO010726	LDT 10X90/35-5 T.HEX. A4	L 90 MM	Ep 35 MM D 10 MM	58811
CO010724	LDT 8X100/55-35 T.HEX.	L 100 MM	Ep 55 MM D 08 MM	58737
CO010694	LDT 8X70/25-5 T.HEX.	L 70 MM	Ep 25 MM D 08 MM	58735
CO010727	8X70/25-5 T.HEX. A4	L 70 MM	Ep 25 MM D 08 MM	58809

photos non contractuelles

ANNEAU DE LEVAGE POUR ASCENSEUR HAP

HILTI



RÉF. ART.	DESCRIPTION	REFERENCE FABRICANT
CO010961	1.15 LOT DE 2	2032179

BROCHE D'ISOLATION IDMR

HILTI



Fixation résistante au feu pour matériel isolant jusqu'à 150 mm d'épaisseur

RÉF. ART.	DESCRIPTION	LONGUEUR	REFERENCE FABRICANT
CO011072	IDMR 0/3 LOT DE 250	L 80 MM	65786

BROCHE D'ISOLATION IDMS

HILTI



Fixation résistante au feu pour matériel isolant jusqu'à 150 mm d'épaisseur

RÉF. ART.	DESCRIPTION	LONGUEUR	REFERENCE FABRICANT
CO000310	IDMS 0/3 BOITE DE 250	L 80 MM	65752
CO000311	IDMS 12X15 BOITE DE 150	L 200 MM	45358
CO000312	IDMS 3/6 BOITE DE 250	L 110 MM	65753
CO000313	IDMS 6/9 BOITE DE 250	L 140 MM	65754
CO000314	IDMS 9/12 BOITE DE 150	L 170 MM	65725

BROCHE D'ISOLATION IDP

HILTI

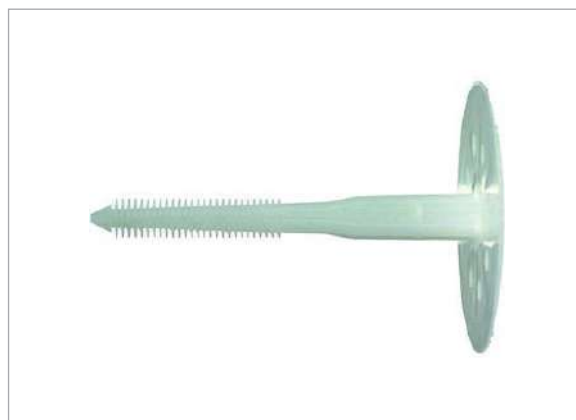

Cheville d'isolation

RÉF. ART.	DESCRIPTION	LONGUEUR	REFERENCE FABRICANT
CO000315	IDP 0/2 BTE DE 250	L 50 MM	332105
CO000317	IDP 13/15 BTE DE 250	L 180 MM	332111
CO010048	IDP 2/4 (BOITE DE 250)	L 70 MM	332106
CO009165	IDP 4/6 BOITE DE 250	L 90 MM	332107
CO009698	IDP 8/10 BTE DE 250	L 130 MM	332109

photos non contractuelles

CHEVILLE CHARGES LOURDES HSL-3-R

HILTI



RÉF. ART.	DESCRIPTION	REFERENCE FABRICANT
CO019022	M8 20/93/- BT DE 40	2159877
CO019023	M8 40/20/113- BT DE 40	2159878
CO019015	M10 20/107/-BT DE 20	2159980
CO019016	M10 40/20/127 BT DE 20	2159981
CO019017	M12 25/124/- BT DE 20	2159983
CO019018	M12 50/25/149 BT DE 10	2159984
CO019019	M16 25/145/- BT DE 10	2159986
CO019020	M16 50/25/170 BT DE 10	2159987
CO019021	M20 30/170/- BT DE 6	2159989
CO019014	M20 60/30/-200 BT DE 6	2159990

CHEVILLE A EXPANSION HAM

HILTI



Cheville à expansion économique avec vis et rondelle

RÉF. ART.	DESCRIPTION	LONGUEUR	DIAMETRE	REFERENCE FABRI-CANT
CO000556	M8X60 BOITE DE 50	L 60 MM	D 08 MM	305858
CO000553	M10X80 BOITE DE 25	L 80 MM	D 10 MM	305859
CO000558	M12 BOITE DE 100	L 95 MM	D 12 MM	305856

CHEVILLE A EXPANSION HLC-EC

HILTI



Une seule cheville pour tous les supports creux de 10 à 92 mm

RÉF. ART.	DESCRIPTION	LONGUEUR	DIAMETRE	REFERENCE FABRI-CANT
CO000582	8X40 BOITE DE 50	L 40 MM	D 08 MM	385871
CO000580	10X50 BOITE DE 50	L 50 MM	D 10 MM	385872
CO000581	16X100 BOITE DE 10	L 100 MM	D 16 MM	385873

CHEVILLE A EXPANSION HLC-EO

HILTI



Une seule cheville pour tous les supports creux de 10 à 92 mm

RÉF. ART.	DESCRIPTION	LONGUEUR	DIAMETRE	REFERENCE FABRI-CANT
CO000583	8X40 BOITE DE 50	L 40 MM	D 08 MM	385875

CHEVILLE A EXPANSION HLC-H



Cheville à expansion économique avec tête hexagonale

RÉF. ART.	DESCRIPTION	LON- GUEUR	DIAMETRE	REFERENCE FABRICANT
CO000588	12X100/60 BOITE DE 25	L 100 MM	Ep 60 MM D 12 MM	385852
CO000595	8X55/25 BOITE DE 100	L 55 MM	Ep 25 MM D 08 MM	385838

CHEVILLE A FRAPPER HPS-1



Fixation facile, multi-matériaux version standard - Diamètre/Epaisseur de la picée à fixer X Longueur sous tête/

RÉF. ART.	DESCRIPTION	LON- GUEUR	DIAMETRE	REFERENCE FABRICANT
CO000615	HPS-1 5/0X20 BOITE DE 250	L 22 MM	Ep 02 MM D 05 MM	260395
CO000616	HPS-1 5/10X30 BOITE DE 200	L 30 MM	Ep 10 MM D 05 MM	230515
CO000617	HPS-1 5/15X35 BOITE DE 200	L 27 MM	Ep 15 MM D 05 MM	260348
CO000618	HPS-1 5/30X50 BOITE 150	L 52 MM	Ep 30 MM D 05 MM	230529
CO000619	HPS-1 5/5X25 BT 200	L 27 MM	Ep 05 MM D 05 MM	260347
CO000620	HPS-1 6/10X35 BTE DE 150	L 37 MM	Ep 10 MM D 06 MM	230516
CO000621	HPS-1 6/15X40 BTE DE 150	L 42 MM	Ep 15 MM D 06 MM	260350
CO000622	HPS-1 6/25X50 BTE DE 100	L 52 MM	Ep 25 MM D 06 MM	260351
CO000623	HPS-1 6/30X55 BTE DE 100	L 57 MM	Ep 30 MM D 06 MM	230517
CO000624	HPS-1 6/40X65 BTE DE 100	L 67 MM	Ep 40 MM D 06 MM	260352
CO000625	HPS-1 6/5X30 BTE DE 150	L 32 MM	Ep 05 MM D 06 MM	260349
CO000645	HPS-1-6/0X25 BTE DE 150	L 32 MM	Ep 02 MM D 06 MM	238159
CO000646	HPS-1-8/0X25 BTE DE 100			238160
CO000626	HPS-1 8/10X40 BTE DE 100	L 43 MM	Ep 10 MM D 08 MM	260353
CO000627	HPS-1 8/20X50 BTE DE 50	L 53 MM	Ep 20 MM D 08 MM	230518
CO000628	HPS-1 8/30X60 BTE DE 50	L 63 MM	Ep 30 MM D 08 MM	260354
CO000629	HPS-1 8/40X70 BOITE DE 50	L 73 MM	Ep 40 MM D 08 MM	230519
CO000630	HPS-1 8/60X90 BTE DE 50	L 93 MM	Ep 60 MM D 08 MM	260355
CO000612	HPS-1-8/100 X 130 BTE DE 100	L 133 MM	Ep 100 MM D 08 MM	260367
CO000631	HPS-1 8/80X110 BTE DE 50	L 113 MM	Ep 80 MM D 08 MM	260356
CO000634	HPS-1 R 5/15X35 BOITE DE 200	L 37 MM	Ep 15 MM D 05 MM	260358
CO000635	HPS-1 R 5/5X25 BOITE DE 200	L 27 MM	Ep 05 MM D 05 MM	260357
CO000637	HPS-1 R 6/0X25 BOITE DE 150	L 27 MM	Ep 02 MM D 06 MM	238161
CO000638	HPS-1 R 6/10X35 BOITE 150	L 37 MM	Ep 10 MM D 06 MM	230525
CO000639	HPS-1 R 6/15X40 BOITE DE 100	L 42 MM	Ep 15 MM D 06 MM	260360

photos non contractuelles

RÉFÉRENCE ARTICLE	DESCRIPTION	LON- GUEUR	DIAME- TRE		
CO000640	HPS-1 R 6/25X50 BOITE DE 100	L 52 MM	Ep 25 MM	D 06 MM	260361
CO000613	HPS-1 R-6/40 X 65 BTE DE 100	L 67 MM	Ep 40 MM	D 06 MM	260362
CO000641	HPS-1 R 6/5X30 BOITE DE 150	L 32 MM	Ep 05 MM	D 06 MM	260359
CO000642	HPS-1 R 8/10X40 BOITE DE 100	L 43 MM	Ep 10 MM	D 08 MM	260363
CO000643	HPS-1 R 8/30X60 BOITE DE 50	L 63 MM	Ep 30 MM	D 08 MM	260364
CO000644	HPS-1 R 8/60X90 BOITE DE 50	L 93 MM	Ep 60 MM	D 08 MM	260365

CHEVILLE A SEGMENT HSV

HILTI



SUR COMMANDE

Goujon à frapper HSV

RÉF. ART.	DESCRIPTION	LON- GUEUR	EPAIS- SEUR	DIAMETRE	REFERENCE FABRICANT
CO000647	M10X100 BOITE DE 50	L 100 MM	Ep 35 MM	D 10 MM	2041606
CO000648	M12X120 BOITE DE 30	L 120 MM	Ep 40 MM	D 12 MM	2041609

CHEVILLE CADRE HRD

HILTI



SUR COMMANDE

Fixation facile, multi-matériaux version standard - Diamètre/Epaisseur de la pièce à fixer X Longueur sous tête - 100 - 50

RÉF. ART.	DESCRIPTION	LON- GUEUR	DIAME- TRE	REFERENCE FABRICANT
CO000649	HRD-C 10X310 EN BOITE DE 50	L 310 MM	Ep 160 MM	D 10 MM 423869
CO011475	HRD-HR 10X80 LOT DE 50	L 80 MM	Ep 30 MM	D 10 MM 423889
CO009051	HRD-P 10X80 BOITE DE 50	L 80 MM	Ep 30 MM	D 10 MM 423884
CO011480	HRD-P 10X140 BOITE DE 50	L 140 MM	Ep 10 MM	D 10 MM 2009875
CO011482	HRD-PR2 10X80 LOT DE 50	L 80 MM	Ep 30 MM	D 10 MM 423908
CO000655	HRD-UGT 14X110X40 BOITE DE 50	L 110 MM	Ep 40 MM	D 14 MM 312623

CHEVILLE CHAMBRAGE HDA-P



Cheville de chambrage pré-installée haute performance pour charges dynamiques (zinguée)

RÉF. ART.	DESCRIPTION	LON- GUEUR	DIAMÈ- TRE	REFERENCE FABRICANT
CO009595	HDA-P M12x125/30 BTE DE 8	L 125 MM	Ep 30 MM D 12 MM	331546
CO009596	HDA-P M16x190/40 BOITE DE 4	L 190 MM	Ep 40 MM D 16 MM	331550
CO000663	HDA-PR 20- M12X125/50 BOITE DE 8	L 125 MM	Ep 50 MM D 12 MM	339348
CO010252	HDA-T M12X125/30 BOITE DE 8	L 125 MM	Ep 30 MM D 12 MM	331548

OUTIL DE POSE TE-Y-HDA



Outil de pose – nécessaire à l'installation des chevilles à verrouillage de forme HDA

RÉF. ART.	DESCRIPTION	REFERENCE FABRICANT
CO009474	TE-Y-HDA-ST 22-M12- SDS MAX	287134
CO009475	TE-Y-HDA-ST 30-M16- SDS MAX	331846

CHEVILLE COMPACTE HKD



Cheville femelle à frapper standard à pose avec outil (acier au carbone)

RÉF. ART.	DESCRIPTION	LON- GUEUR	DIAMETRE	REFERENCE FAB- RICANT
CO009937	HKD M20X80 EN BOITE DE 25	L 80 MM	D 20 MM	382955
CO009911	HKD M10X30 EN BOITE DE 100	L 30 MM	D 10 MM	376965
CO009909	HKD M12X25 EN BOITE DE 100	L 25 MM	D 12 MM	378431
CO000712	HKD M12X50 EN BOITE DE 50	L 50 MM	D 12 MM	378544
CO000713	HKD M16X65 EN BOITE DE 25	L 65 MM	D 16 MM	382941
CO000714	HKD M6X25 EN BOITE DE 100	L 25 MM	D 06 MM	376894
CO000715	HKD M8X25 EN BOITE DE 100	L 25 MM	D 08 MM	376957
CO000716	HKD M8X40 EN BOITE DE 50	L 40 MM	D 08 MM	376961
CO011495	HKD M10X25 LOT DE 100	L 25 MM	D 10 MM	2037453
CO011494	HKD M10X25 SEAU LOT DE 500	L 25 MM	D 10 MM	2037454
CO011496	HKD M10X30 SEAU LOT DE 500	L 30 MM	D 10 MM	376966
CO011498	HKD M10X40 LOT DE 50	L 40 MM	D 10 MM	376967
CO011503	HKD M8X25 BULK LOT DE 1000	L 25 MM	D 08 MM	401550
CO011504	HKD M8X25 SEAU LOT DE 500	L 25 MM	D 08 MM	376958
CO011506	HKD M8X30 LOT DE 100	L 30 MM	D 08 MM	376959
CO008644	HKD-D M12X50 BTE DE 50	L 50 MM	D 12 MM	385459

photos non contractuelles

CHEVILLE COMPACTE HKD-SR



Cheville femelle à frappe zinguée avec colerette, version inox

RÉF. ART.	DESCRIPTION	LON- GUEUR	DIAMETRE	REFERENCE FAB- RICANT
CO000717	HKD-SR M10X40 BOITE DE 50	L 40 MM	D 10 MM	247953
CO000720	HKD-SR M12 X 50 BTE DE 50	L 50 MM	D 12 MM	247954
CO000721	HKD-SR M16 X 65 BTE DE 25	L 65 MM	D 16 MM	247955
CO000718	HKD-SR M20X80 BOITE DE 25	L 80 MM	D 20 MM	247956
CO000719	HKD-SR M6X25 BOITE DE 100	L 25 MM	D 06 MM	247951
CO000722	HKD-SR M8 X 30 BTE DE 100	L 30 MM	D 08 MM	247952

OUTIL DE POSE HKD-TE-CX



Pour chevilles HKD Hilti

RÉF. ART.	DESCRIPTION	REFERENCE FABRICANT
CO014396	M10X25	414480
CO014397	M6 1/4"X25"	414472
CO014399	M8X25	414475

OUTIL DE POSE HSD



Pour chevilles HSD Hilti

RÉF. ART.	DESCRIPTION	REFERENCE FABRICANT
CO003316	M10 3/8X30	230935
CO003317	M10 3/8 X40	243742
CO003318	M12 1/2" X 50	243743
CO003319	M16 5/8" X 65	243744
CO003320	M20 3/4 X80	243745
CO003321	M6 1/4 X25	243738
CO003322	M8 X 30 POUR HKD M8 / 5/16x30	243740
CO010089	M8 X 40 POUR HKD M8 / 5/16x40	243741
CO003323	HSD-M M10 3/8 X30	243750
CO003324	HSD-M M10 3/8 X40	243751
CO003326	HSD-M M16 5/8 X65	243753
CO003329	HSD-M M8 5/16 X30	243748
CO003330	HS-SC M6-M12/300	337919
CO009227	HS-SC M6-M16	2051443

CHEVILLE DE SECURITE HSC-A



Conçue pour des fixations pour des charges lourdes à de faibles distance au bord. En version inox

RÉF. ART.	DESCRIPTION	LON- GUEUR	DIAMETRE	REFERENCE FABRICANT
CO000724	HSC-A M10X40/20 BOITE DE 25	L 40 MM	Ep 20 MM	D 10 MM 31140
CO000725	HSC-A M8X40/15 BOITE DE 25	L 40 MM	Ep 15 MM	D 08 MM 31139
CO000726	HSC-A M8X50/15 BOITE DE 25	L 50 MM	Ep 15 MM	D 08 MM 31141

photos non contractuelles

CHEVILLE DE SECURITE HSC-AM



Conçue pour des fixations pour des charges lourdes à de faibles distance au bord. En version inox

RÉF. ART.	DESCRIPTION	LON-GUEUR	DIAMETRE	REFERENCE FABRICANT
CO000727	HSC-AM M12X60/20 BOITE DE 20	L 60 MM	Ep 20 MM D 12 MM	15507

CHEVILLE DE SECURITE HSC-AR



Conçue pour des fixations pour des charges lourdes à de faibles distance au bord. En version inox

RÉF. ART.	DESCRIPTION	LON-GUEUR	DIAMETRE	REFERENCE FABRICANT
CO000728	HSC-AR M10X40/20 BOITE DE 25	L 40 MM	Ep 20 MM D 10 MM	31149
CO000729	HSC-AR M12X60/20 BOITE DE 20	L 60 MM	Ep 20 MM D 12 MM	15506
CO000730	HSC-AR M8X40/15 BOITE DE 25	L 40 MM	Ep 15 MM D 08 MM	31148

CHEVILLE DE SECURITE HSC-I



Conçue pour des fixations pour des charges lourdes à de faibles distance au bord. En version acier galvanisé

RÉF. ART.	DESCRIPTION	LON-GUEUR	DIAMETRE	REFERENCE FABRICANT
CO000733	HSC-I M12X60 BOITE DE 25	L 60 MM	D 12 MM	31146
CO000734	HSC-I M6X40 BOITE DE 25	L 40 MM	D 06 MM	31142
CO000735	HSC-I M8X40 BOITE DE 25	L 40 MM	D 08 MM	31143

CHEVILLE DE SECURITE HSC-IR



Conçue pour des fixations pour des charges lourdes à de faibles distance au bord. En version acier galvanisé

RÉF. ART.	DESCRIPTION	LON-GUEUR	DIAMETRE	REFERENCE FABRICANT
CO000736	HSC-IR M10X50 BOITE DE 25	L 50 MM	D 10 MM	31153
CO000737	HSC-IR M10X60 BOITE DE 25	L 60 MM	D 10 MM	31154
CO000739	HSC-IR M6X40 BOITE DE 25	L 40 MM	D 06 MM	31151

photos non contractuelles

CHEVILLE ECHAFAUDAGE GD

HILTI

Cheville en plastique économique pour échafaudage

RÉF. ART.	DESCRIPTION	LONGUEUR	DIAMETRE	REFERENCE FABRICANT
CO000741	14/100 BOITE DE 50	L 100 MM	D 14 MM	45455
CO000743	14/70 BOITE DE 50	L 70 MM	D 14 MM	45454

CHEVILLE ECLAIR DBZ

HILTI

Tap-vis métallique pour suspensions

RÉF. ART.	DESCRIPTION	LON- GUEUR	EPAIS- SEUR	DIAMETRE	REFERENCE FABRICANT
CO000744	6/35 BTE DE 100	L 71 MM	Ep 35 MM	D 06 MM	256311
CO000745	6/4,5 BTE DE 100	L 40 MM	Ep 05 MM	D 06 MM	256312

Cheville HSL4

HILTI

RÉF. ART.	DESCRIPTION	REFERENCE FABRICANT
CO105373	HSL4 M10 d15x109 20/-/- - LOT DE 20	2237418
CO105374	HSL4 M10 d15x129 40/20/- - LOT DE 20	2237416
CO105375	HSL4 M10 d15x94 5/-/- - LOT DE 20	2237417
CO105376	HSL4 M12 d18x131 25/-/- - LOT DE 20	2237412
CO105377	HSL4 M12 d18x156 50/25/- - LOT DE 10	2237410
CO105378	HSL4 M16 d24x153 25/-/- - LOT DE 10	2237408
CO105379	HSL4 M16 d24x178 50/25/- - LOT DE 10	2237407
CO105380	HSL4 M20 d28x183 30/-/- - LOT DE 6	2237405
CO105381	HSL4 M20 d28x213 60/30/- - LOT DE 6	2237404
CO105382	HSL4 M24 d32x185 10/-/- - LOT DE 4	2237403
CO105383	HSL4 M24 d32x205 30/-/- - LOT DE 4	2237402
CO105384	HSL4 M24 d32x235 60/30/- - LOT DE 4	2237428
CO105385	HSL4 M8 d12x117 40/20/- - LOT DE 40	2237400
CO105386	HSL4 M8 d12x97 20/-/- - LOT DE 40	2237399

Cheville HSL4 B

HILTI

RÉF. ART.	DESCRIPTION	REFERENCE FABRICANT
CO105393	HSL4-B M20 d28x198 30/-/- - LOT DE 6	2237430

Cheville HSL4-G



RÉF. ART.	DESCRIPTION	REFERENCE FABRICANT
CO105397	HSL4-G M10 d15x121 20/-/- - LOT DE 20	2237435
CO105398	HSL4-G M10 d15x141 40/20/- - LOT DE 20	2237436
CO105399	HSL4-G M10 d15x161 60/40/20 - LOT DE 20	2237438
CO105400	HSL4-G M12 d18x127 5/-/- - LOT DE 20	2237441
CO105401	HSL4-G M12 d18x147 25/-/- - LOT DE 20	2237440
CO105402	HSL4-G M12 d18x172 50/25/- - LOT DE 10	2237442
CO105403	HSL4-G M12 d18x192 70/45/20 - LOT DE 10	2237443
CO105404	HSL4-G M12 d18x222 100/75/50 - LOT DE 10	2237439
CO105405	HSL4-G M16 d24x175 25/-/- - LOT DE 10	2237444
CO105406	HSL4-G M16 d24x200 50/25/- - LOT DE 10	2237445
CO105407	HSL4-G M16 d24x230 80/55/30 - LOT DE 10	2237446
CO105409	HSL4-G M20 d28x185 10/-/- - LOT DE 6	2237447
CO105410	HSL4-G M20 d28x205 30/-/- - LOT DE 6	2237449
CO105411	HSL4-G M20 d28x235 60/30/- - LOT DE 6	2237373
CO105413	HSL4-G M8 d12x107 20/-/- - LOT DE 40	2237456
CO105414	HSL4-G M8 d12x127 40/20/- - LOT DE 40	2237457
CO105415	HSL4-G M8 d12x147 60/40/20 - LOT DE 40	2237459
CO105417	HSL4-G M8 d12x92 5/-/- - LOT DE 40	2237458

Cheville HSL4-SK



RÉF. ART.	DESCRIPTION	REFERENCE FABRICANT
CO105418	HSL4-SK M10 d15x100 20/-/- - LOT DE 20	2237395

CHEVILLE LAITON A EXPANSION



Fixation simple et rapide pour charges légères

RÉF. ART.	DESCRIPTION	DIAMETRE	REFERENCE FABRICANT
CO000747	HEL M8 BOITE DE 50	D 08 MM	355410
CO011523	HEL M10 LOT DE 50	D 10 MM	355411

photos non contractuelles

CHEVILLE MÂLE HST3

HILTI



Cheville à expansion haute performance pour béton fissuré et zone sismique (CS)

RÉF. ART.	DESCRIPTION	LON-GUEUR	DIAMÈ-TRE	REFERENCE FABRICANT
CO010348	M10X100 40/20 BOITE DE 50	L 100 MM	Ep 40 MM D 10 MM	2105713
CO011525	M10X100 40/20 BW LOT DE 25	L 100 MM	Ep 40 MM D 10 MM	2105882
CO011526	M10X110 50/30 LOT DE 40	L 110 MM	Ep 50 MM D 10 MM	2105714
CO010651	M10X130 70/50 BOITE DE 25	L 130 MM	Ep 70 MM D 10 MM	2105715
CO010907	M10X160 100/80 BOITE DE 25	L 160 MM	Ep 100 MM D 10 MM	2105716
CO011528	M10X70 10/- LOT DE 50	L 70 MM	Ep 10 MM D 10 MM	2113974
CO011529	M10X80 20/- LOT DE 50	L 80 MM	Ep 20 MM D 10 MM	2113975
CO010648	M10X90 30/10 BOITE DE 50	L 90 MM	Ep 30 MM D 10 MM	2105712
CO010650	M12X105 30/10 BOITE DE 25	L 105 MM	Ep 30 MM D 12 MM	2105718
CO011530	M12X115 40/20 BW LOT DE 16	L 115 MM	Ep 40 MM D 12 MM	2105883
CO011531	M12X115 40/20 LOT DE 25	L 115 MM	Ep 40 MM D 12 MM	2105719
CO011532	M12X125 50/30 LOT DE 25	L 125 MM	Ep 50 MM D 12 MM	2105850
CO010649	M12X145 70/50 BOITE DE 25	L 145 MM	Ep 70 MM D 12 MM	2105851
CO011533	M12X165 90/70 LOT DE 25	L 165 MM	Ep 90 MM D 12 MM	2105852
CO011534	M12X185 110/90 LOT DE 25	L 185 MM	Ep 110 MM D 12 MM	2105853
CO011535	M12X235 160/140 LOT DE 25	L 235 MM	Ep 160 MM D 12 MM	2105855
CO011536	M12X255 180/160 LOT DE 25	L 255 MM	Ep 180 MM D 12 MM	2105856
CO011537	M12X295 220/200 LOT DE 25	L 295 MM	Ep 220 MM D 12 MM	2105857
CO011538	M12X85 10/- LOT DE 25	L 85 MM	Ep 10 MM D 12 MM	2113978
CO011539	M12X95 20/- LOT DE 25	L 95 MM	Ep 20 MM D 12 MM	2113979
CO010882	M16X115/15/- BOITE DE 12	L 115 MM	Ep 15 MM D 16 MM	2114053
CO010763	M16X135/35/15 BOITE DE 12	L 135 MM	Ep 35 MM D 16 MM	2105858
CO011540	M16X145 45/25 LOT DE 12	L 145 MM	Ep 45 MM D 16 MM	2105859
CO011541	M16X170 70/50 LOT DE 12	L 170 MM	Ep 70 MM D 16 MM	2105860

photos non contractuelles

RÉFÉRENCE	ARTICLE	DESCRIPTION	LON-GUEUR	DIAMÈ-TRE
CO011542	M16X220 120/100 LOT DE 12	L 220 MM	Ep 120 MM D 16 MM	2105861
CO011543	M16X260 160/140 LOT DE 12	L 260 MM	Ep 160 MM D 16 MM	2105862
CO011544	M16X300 200/180 LOT DE 12	L 300 MM	Ep 200 MM D 16 MM	2105863
CO011545	M20X170 -/30 LOT DE 5	L 170 MM	D 20 MM	2105891
CO011546	M20X200 -/60 LOT DE 5	L 200 MM	D 20 MM	2105892
CO011547	M20X260 -/120 LOT DE 5	L 260 MM	D 20 MM	2105893
CO011548	M24X200 -/30 LOT DE 5	L 200 MM	D 24 MM	2105894
CO011549	M24X230 -/60 LOT DE 5	L 230 MM	D 24 MM	2105895
CO011550	M8X115 -/50 LOT DE 50	L 115 MM	D 08 MM	2105890
CO011552	M8X75 -/10 LOT DE 100	L 75 MM	D 08 MM	2105888
CO011551	M8X75 -/10 BW LOT DE 100	L 75 MM	D 08 MM	2105903
CO010405	M8X95/30 BOITE DE 80	L 95 MM	D 08 MM	2105889

CHEVILLE MÂLE HST3-R



Cheville haute performance pour béton fissuré et zone sismique (A4 SS + grande rondelle)

RÉF. ART.	DESCRIPTION	LON- GUEUR	DIAMÈ- TRE	REFERENCE FABRICANT
CO011553	M10X100 40/20 BW LOT DE 25	L 100 MM	Ep 40 MM D 10 MM	2105885
CO011554	M10X100 40/20 LOT DE 50	L 100 MM	Ep 40 MM D 10 MM	2105865
CO011555	M10X110 50/30 LOT DE 40	L 110 MM	Ep 50 MM D 10 MM	2105866
CO011556	M10X130 70/50 LOT DE 25	L 130 MM	Ep 70 MM D 10 MM	2105867
CO011557	M10X160 100/80 LOT DE 25	L 160 MM	Ep 100 MM D 10 MM	2105868
CO011558	M10X70 10/- LOT DE 50	L 70 MM	Ep 10 MM D 10 MM	2113976
CO011559	M10X80 20/- LOT DE 50	L 80 MM	Ep 20 MM D 10 MM	2113977
CO011560	M10X90 44134 LOT DE 50	L 90 MM	Ep 30 MM D 10 MM	2105864
CO011561	M12X105 44134 LOT DE 25	L 105 MM	Ep 30 MM D 12 MM	2105869
CO011563	M12X115 40/20 LOT DE 25	L 115 MM	Ep 40 MM D 12 MM	2105870
CO011564	M12X125 50/30 LOT DE 25	L 125 MM	Ep 50 MM D 12 MM	2105871
CO011565	M12X145 70/50 LOT DE 25	L 145 MM	Ep 70 MM D 12 MM	2105872
CO011566	M12X165 90/70 LOT DE 25	L 165 MM	Ep 90 MM D 12 MM	2105873
CO011567	M12X185 110/90 LOT DE 25	L 185 MM	Ep 110 MM D 12 MM	2105874
CO011569	M12X85 10/- LOT DE 25	L 85 MM	Ep 10 MM D 12 MM	2114051
CO011570	M12X95 20/- LOT DE 25	L 95 MM	Ep 20 MM D 12 MM	2114052
CO011571	M16X115 15/- LOT DE 12	L 115 MM	Ep 15 MM D 16 MM	2114057
CO011572	M16X135 35/15 LOT DE 12	L 135 MM	Ep 35 MM D 16 MM	2105876
CO011573	M16X145 45/25 BW LOT DE 12	L 145 MM	Ep 45 MM D 16 MM	2105887
CO011574	M16X145 45/25 LOT DE 12	L 145 MM	Ep 45 MM D 16 MM	2105877
CO011575	M16X170 70/50 LOT DE 12	L 170 MM	Ep 70 MM D 16 MM	2105878
CO011576	M16X220 120/100 LOT DE 12	L 220 MM	Ep 120 MM D 16 MM	2105879
CO011577	M16X260 160/140 LOT DE 12	L 260 MM	Ep 160 MM D 16 MM	2105880
CO011578	M16X300 200/180 LOT DE 12	L 300 MM	Ep 200 MM D 16 MM	2105881

RÉFÉRENCE ARTICLE	DESCRIPTION	LON- GUEUR	DIAMÈ- TRE	
CO011579	M20X170 -/30 LOT DE 5	L 170 MM	D 20 MM	2105899
CO011580	M20X200 -/60 LOT DE 5	L 200 MM	D 20 MM	2105900
CO011581	M24X200 -/30 LOT DE 5	L 200 MM	D 24 MM	2105901
CO011582	M24X230 -/60 LOT DE 5	L 230 MM	D 24 MM	2105902
CO011583	M8X115 -/50 LOT DE 50	L 115 MM	D 08 MM	2105898
CO011584	M8X75 -/10 BW LOT DE 100	L 75 MM	D 08 MM	2105904
CO011585	M8X75 -/10 LOT DE 50	L 75 MM	D 08 MM	2105896
CO010759	M8X95/30 BOITE DE 50	L 95 MM	D 08 MM	2105897

CHEVILLE MET. MAT. CREUX HTB



Une seule cheville pour tous les supports creux de 10 à 92 mm

RÉF. ART.	DESCRIPTION	LONGUEUR	DIAMETRE	REFERENCE FABRI- CANT
CO000782	M6 BOITE DE 100	L 64 MM	D 06 MM	2158763
CO000783	M5X60 BTE 100	L 64 MM	D 05 MM	2158764
CO000784	M6X60 BTE 100	L 64 MM	D 06 MM	2158765

CHEVILLE POUR CHARGES LEGÈRES



RÉF. ART.	DESCRIPTION	LONGUEUR	DIAMETRE	REFERENCE FABRI- CANT
CO011590	HLD 2 LOT DE 150	L 28 MM	D 10 MM	335506
CO011591	HLD 3 LOT DE 100	L 35 MM	D 10 MM	335507

photos non contractuelles

CHEVILLE P. MAT CREUX HHD

HILTI



Cheville pour matériaux creux économique

RÉF. ART.	DESCRIPTION	LON- GUEUR	DIAMÈ- TRE	REPERE FABRICANT
CO009206	HHD-S M6/12X52 BOITE DE 50	L 52 MM	Ep 30 MM D 06 MM	332070
CO009929	HHD-S M6/24X65 BOITE DE 50	L 65 MM	Ep 30 MM D 06 MM	332071
CO009207	HHD-S M8/12X54 BOITE DE 50	L 54 MM	Ep 30 MM D 08 MM	332073

CHEVILLE PIEUVRE HHD

HILTI



Cheville pour matériaux creux économique avec vis à tête hexagonale

RÉF. ART.	DESCRIPTION	LON- GUEUR	DIAMÈ- TRE	REPERE FABRICANT
CO009052	HHD-S M8/24X66 BOITE DE 50	L 66 MM	Ep 30 MM D 08 MM	332074

OUTIL DE POSE HHD-S

HILTI



Pour chevilles HHD Hilti

RÉF. ART.	REFERENCE FABRICANT
CO003303	332076

CHEVILLE PLAQUE DE PLÂTRE HSP-S

HILTI

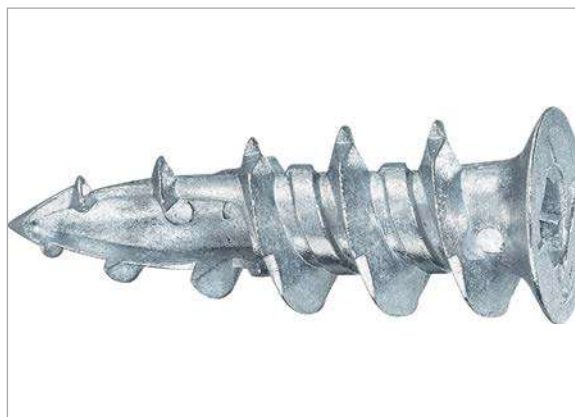

Cheville métallique pour plaque de plâtre

RÉF. ART.	DIAMETRE	REFERENCE FABRICANT
CO018001	D 05 MM	2158778

CHEVILLE PLASTIQUE HRD-C



Cheville plastique - Tous matériaux version tête fraisée

RÉF. ART.	DESCRIPTION	LON- GUEUR	EPAIS- SEUR	DIAMETRE	REFERENCE FABRICANT
CO000786	8X100 BOITE DE 50	L 100 MM	Ep 50 MM	D 08 MM	202343
CO000787	8X120 BOITE DE 50	L 120 MM	Ep 70 MM	D 08 MM	202344
CO000788	8X140BOITE DE 50	L 140 MM	Ep 90 MM	D 08 MM	202345
CO000789	8X60 BOITE DE 50	L 60 MM	Ep 10 MM	D 08 MM	202341
CO000790	8X80 BOITE DE 50	L 80 MM	Ep 30 MM	D 08 MM	202342

CHEVILLE POUR BETON CELLULAIRE

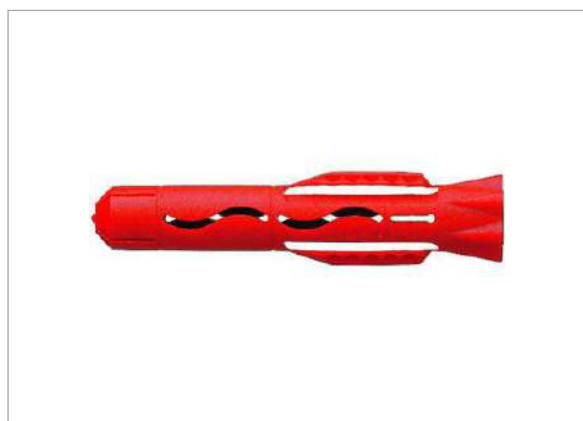

Chevilles universelles tous matériaux pour charges légères

RÉF. ART.	DESCRIPTION	LON- GUEUR	EPAIS- SEUR	DIAMETRE	REFERENCE FABRICANT
CO000792	HGN 14 BOITE DE 50	L 85 MM		D 14 MM	45627
CO000793	HPD M10/10 BT DE 25	L 90 MM	Ep 10 MM	D 10 MM	373478

CHEVILLE SEGMENT HSA



Goujon d'ancrage prémonté avec repère d'enfoncement - Goujon à frapper Electrozingué

RÉF. ART.	DESCRIPTION	LON- GUEUR	DIAME- TRE	REFERENCE FABRICANT
CO000802	6 20/10/ BOITE DE 200	L 65 MM	Ep 20 MM D 06 MM	2036085
CO000803	6 5/-/ BOITE DE 200	L 50 MM	Ep 05 MM D 06 MM	2036084
CO000808	M10 105/95/65 BOITE DE 25	L 168 MM	Ep 105 MM D 10 MM	2004153
CO000809	M10 35/25/BOITE DE 40	L 98 MM	Ep 35 MM D 10 MM	2004129
CO000810	M10 5/-/BOITE DE 50	L 68 MM	Ep 05 MM D 10 MM	2004127
CO009063	M10 50/40/10 BOITE DE 40	L 113 MM	Ep 50 MM D 10 MM	2004150
CO000811	M10 70/60/30 BOITE DE 25	L 133 MM	Ep 70 MM D 10 MM	2004151
CO000812	M10 90/80/50 BOITE DE 25	L 153 MM	Ep 90 MM D 10 MM	2004152
CO000801	M10/20/10/BOITE DE 50	L 83 MM	Ep 20 MM D 10 MM	2004128
CO000813	M12 125/110/75 BOITE DE 25	L 205 MM	Ep 125 MM D 12 MM	2004159
CO000814	M12 145/130/95 BOITE DE 25	L 225 MM	Ep 145 MM D 12 MM	2004160
CO000819	M12 175 95/80/45 BOITE DE 25	L 175 MM	Ep 95 MM D 12 MM	2004158
CO000815	M12 20/5/BOITE DE 25	L 100 MM	Ep 20 MM D 12 MM	2004155
CO000816	M12 35/20/BOITE DE 25	L 115 MM	Ep 35 MM D 12 MM	2004156
CO000817	M12 5/-/BOITE DE 25	L 85 MM	Ep 05 MM D 12 MM	2004154
CO000818	M12 65/50/15 BOITE DE 25	L 145 MM	Ep 65 MM D 12 MM	2004157
CO000820	M16 135/120/80 BOITE DE 16	L 232 MM	Ep 135 MM D 16 MM	2004165
CO000821	M16 20/5/BOITE DE 16	L 117 MM	Ep 20 MM D 16 MM	2004162
CO000822	M16 40/25/BOITE DE 16	L 137 MM	Ep 40 MM D 16 MM	2004163
CO000823	M16 5/-/BOITE DE 16	L 102 MM	Ep 05 MM D 16 MM	2004161
CO000824	M16 85/70/30 BOITE DE 16	L 182 MM	Ep 85 MM D 16 MM	2004164
CO000804	M20 10/-/ BOITE DE 10	L 125 MM	Ep 10 MM D 20 MM	2036088
CO000805	M20 55/30/15 BOITE DE 10	L 170 MM	Ep 55 MM D 20 MM	2036089
CO000807	M6 55/45/25 BOITE DE 100	L 100 MM	Ep 55 MM D 06 MM	2036087

photos non contractuelles

RÉFÉRENCE ARTICLE	DESCRIPTION	LON-GUEUR	DIAMÈ-TRE	
CO000806	M6X85/40/30/10	L 85 MM	Ep 40 MM D 06 MM	2036086
CO000828	M8 20/10/ BOITE DE 100	L 70 MM	Ep 20 MM D 08 MM	2004123
CO000825	M8 35/25/ BOITE DE 80	L 85 MM	Ep 35 MM D 08 MM	2004124
CO000829	M8 5/-/ BOITE DE 100	L 55 MM	Ep 05 MM D 08 MM	2004122
CO000826	M8 55/45/15 BOITE DE 50	L 105 MM	Ep 55 MM D 08 MM	2004125
CO000827	M8 80/70/40 BOITE DE 50	L 130 MM	Ep 80 MM D 08 MM	2004126

CHEVILLE SEGMENT HSA-F



Goujon d'ancrage pour charge moyenne galvanisée à chaud

RÉF. ART.	DESCRIPTION	LON-GUEUR	DIAMÈ-TRE	REFERENCE FABRICANT
CO000832	M10 20/10/ BOITE DE 50	L 83 MM	Ep 20 MM D 10 MM	2004119
CO000833	M10 35/25/ BOITE DE 40	L 98 MM	Ep 35 MM D 10 MM	2004170
CO000834	M10 5/-/ BOITE DE 50	L 68 MM	Ep 05 MM D 10 MM	2004118
CO000835	M10 50/40/10 BOITE DE 40	L 113 MM	Ep 50 MM D 10 MM	2004171
CO000836	M12 145/130/95 BT DE 25	L 225 MM	Ep 145 MM D 12 MM	2004176
CO000837	M12 20/5/ BOITE DE 25	L 100 MM	Ep 20 MM D 12 MM	2004173
CO000838	M12 35/20/ BOITE DE 25	L 115 MM	Ep 35 MM D 12 MM	2004174
CO000840	M12 5/-/ BOITE DE 25	L 85 MM	Ep 05 MM D 12 MM	2004172
CO000839	M12 65/50/15 BOITE DE 25	L 145 MM	Ep 65 MM D 12 MM	2004175
CO000841	M16 40/25/ BOITE DE 16	L 137 MM	Ep 40 MM D 16 MM	2004178
CO000842	M16 85/70/30 BT DE 16	L 182 MM	Ep 85 MM D 16 MM	2004179

photos non contractuelles

CHEVILLE SEGMENTS HSA-F



Goujon d'ancrage pour charge moyenne galvanisée à chaud - Goujon à frapper Galvanisé à chaud Produit

RÉF. ART.	DESCRIPTION	LON-GUEUR	DIAMÈ-TRE	REFERENCE FABRICANT
CO0008586	M16X100/-/5 - BOITE DE 16	L 102 MM	Ep 05 MM D 16 MM	2004177

CHEVILLE SEGMENT HSA-F



Goujon d'ancrage pour charge moyenne galvanisée à chaud

RÉF. ART.	DESCRIPTION	LON-GUEUR	DIAMÈ-TRE	REFERENCE FABRICANT
CO000830	M20x170 55/30/15 BT DE 10	L 170 MM	Ep 55 MM D 20 MM	2036313
CO000843	M8 20/10/ BOITE DE 100	L 70 MM	Ep 20 MM D 08 MM	2004114
CO000844	M8 35/25/ BOITE DE 80	L 85 MM	Ep 35 MM D 08 MM	2004115
CO000845	M8 5/-/ BOITE DE 100	L 55 MM	Ep 05 MM D 08 MM	2004113
CO000846	M8 55/45/15 BOITE DE 50	L 105 MM	Ep 55 MM D 08 MM	2004116

CHEVILLE SEGMENT HSA-R



Goujon d'ancrage pour charge moyenne en inox

RÉF. ART.	DESCRIPTION	LON-GUEUR	DIAMÈTRE	REFERENCE FABRICANT
CO000866	M6 20/10/BOITE DE 200	L 65 MM	Ep 20 MM D 06 MM	2036315
CO000867	M6 40/30/10 BOITE DE 100	L 85 MM	Ep 40 MM D 06 MM	2036316
CO000868	M6 5/-/BOITE DE 200	L 50 MM	Ep 05 MM D 06 MM	2036314
CO000869	M8 20/10/BOITE DE 100	L 70 MM	Ep 20 MM D 08 MM	2004198
CO000870	M8 35/25/BOITE DE 80	L 85 MM	Ep 35 MM D 08 MM	2004199
CO000871	M8 5/-/BOITE DE 100	L 55 MM	Ep 05 MM D 08 MM	2004197
CO000872	M8 55/45/15 BOITE DE 50	L 105 MM	Ep 55 MM D 08 MM	2004200
CO000848	M10 35/25/BOITE DE 40	L 98 MM	Ep 35 MM D 10 MM	2004203
CO000849	M12 20/5/ BOITE DE 25	L 100 MM	Ep 20 MM D 12 MM	2004208
CO000850	M12 25/20/ boite de 25	L 115 MM	Ep 35 MM D 12 MM	2004209
CO000851	M10 20/10/BOITE DE 50	L 83 MM	Ep 20 MM D 10 MM	2004202
CO000852	M10 5/-/ BOITE DE 50	L 68 MM	Ep 05 MM D 10 MM	2004201
CO000853	M10 50/40/10 BOITE DE 40	L 113 MM	Ep 50 MM D 10 MM	2004204
CO000854	M10 70/60/30 BOITE DE 25	L 133 MM	Ep 70 MM D 10 MM	2004205
CO000855	M10 90/80/50 BOITE DE 25	L 153 MM	Ep 90 MM D 10 MM	2004206
CO000856	M12 125/110/75 BOITE DE 25	L 205 MM	Ep 125 MM D 12 MM	2004212
CO000858	M12 5/-/BOITE DE 25	L 85 MM	Ep 05 MM D 12 MM	2004207
CO000859	M12 65/50/15 BOITE DE 25	L 145 MM	Ep 65 MM D 12 MM	2004210
CO000860	M12 95/80/45 BOITE DE 25	L 175 MM	Ep 95 MM D 12 MM	2004211
CO000861	M16 20/5/BOITE DE 16	L 117 MM	Ep 20 MM D 16 MM	2004215
CO000862	M16 40/25/BOITE DE 16	L 137 MM	Ep 40 MM D 16 MM	2004216
CO000863	M16 5/-/BOITE DE 16	L 102 MM	Ep 05 MM D 16 MM	2004214
CO008777	M20 55/30/-BOITE DE 10	L 170 MM	Ep 55 MM D 20 MM	2036318

CHEVILLE SEGMENT HSA-R2



Goujon à frapper HSA

RÉF. ART.	DESCRIPTION	LON-GUEUR	DIAMÈTRE	REFERENCE FABRICANT
CO000873	M10 20/10/BOITE DE 50	L 83 MM	Ep 20 MM D 10 MM	2004219
CO000874	M12 20/5/BOITE DE 25	L 100 MM	Ep 20 MM D 12 MM	2004220
CO000875	M12 35/20/BOITE DE 25	L 115 MM	Ep 35 MM D 12 MM	2004221
CO000876	M16 40/25/BOITE DE 16	L 137 MM	Ep 40 MM D 16 MM	2004222
CO000877	M8 20/10/BOITE 100	L 70 MM	Ep 20 MM D 08 MM	2004218

CHEVILLE SEGMENTS HSV



RÉF. ART.	DESCRIPTION	LON-GUEUR	EPAIS-SEUR	DIAMÈTRE	REFERENCE FABRICANT
CO011617	M10X90 LOT DE 50	L 90 MM	Ep 35 MM	D 10 MM	2041605
CO011618	M12X100 LOT DE 30	L 100 MM	Ep 40 MM	D 12 MM	2041607
CO011619	M12X110 LOT DE 30	L 110 MM	Ep 40 MM	D 12 MM	2041608
CO011620	M12X150 LOT DE 25	L 150 MM	Ep 40 MM	D 12 MM	2041610
CO011621	M16X120 LOT DE 16	L 120 MM		D 16 MM	2041611
CO011622	M16X140 LOT DE 16	L 140 MM		D 16 MM	2041612
CO011623	M8X75 LOT DE 100	L 75 MM		D 8 MM	2041604

photos non contractuelles

CHEVILLE UNIVERSELLE HUD-1

HILTI



Chevilles universelles - Cheville nylon

RÉF. ART.	DESCRIPTION	LONGUEUR	DIAMETRE	REFERENCE FABRICANT
CO000881	12X60 BOITE DE 100	L 60 MM	D 12 MM	331619
CO000882	ZINGUE LOT DE 20	L 70 MM	D 14 MM	331620
CO000884	10 EN BOITE DE 1200	L 50 MM	D 10 MM	338711
CO000892	10 x 50 BT DE 200	L 50 MM	D 10 MM	331618
CO105422	5x25 (500) - LOT DE 500			2287818
CO105423	6x30 (200) - LOT DE 200			2287819
CO105424	6x30 (500) - LOT DE 500			2287820
CO011626	8X40 (100) LOT DE 100	L 40 MM	D 08 MM	274613
CO105425	8x40 (200) - LOT DE 200			2287822
CO105426	8x40 (400) - LOT DE 400			2287816

CHEVILLE UNIVERSELLE HUD-L

HILTI



Chevilles universelles version longue - Cheville nylon

RÉF. ART.	DESCRIPTION	LONGUEUR	DIAMETRE	REFERENCE FABRICANT
CO000887	10X70 BOITE DE 100	L 70 MM	D 10 MM	315940
CO000888	6X50 BOITE DE 400	L 50 MM	D 06 MM	315938
CO000889	8X60 BOITE DE 200	L 60 MM	D 08 MM	315939

FIXATION ISOLATION HIF

HILTI



Cheville d'isolation Hilti

RÉF. ART.	DESCRIPTION	LONGUEUR	REFERENCE FABRICANT
CO010057	HIF 140 BOITE DE 150	L 165 MM	2061610
CO009700	HIF 200 BOITE DE 100	L 225 MM	2061613

FIXATION ISOLATION IZ

HILTI



Cheville d'isolation Hilti

RÉF. ART.	DESCRIPTION	LONGUEUR	REFERENCE FABRICANT
CO010035	IZ 8x150 BOITE DE 150	L 150 MM	378164

GABARIT D. 8 10 14 POUR HUS3

HILTI



RÉF. ART.	REFERENCE FABRICANT
CO018231	2192594

HRD-C

HILTI



Cheville plastique version 10 mm - Tous matériaux version tête fraisée

RÉF. ART.	DESCRIPTION	LON- GUEUR	EPAIS- SEUR	DIAMETRE	REFERENCE FABRICANT
CO002423	10X100 BOITE DE 50	L 100 MM	Ep 50 MM	D 10 MM	423861
CO002424	10X120 BOITE DE 50	L 120 MM	Ep 70 MM	D 10 MM	423862
CO002425	10X140 BOITE DE 50	L 140 MM	Ep 90 MM	D 10 MM	423863
CO002426	10X160 BOITE DE 50	L 160 MM	Ep 110 MM	D 10 MM	423864
CO002427	10X180 BOITE DE 50	L 180 MM	Ep 130 MM	D 10 MM	423865
CO002428	10X200 BOITE DE 50	L 200 MM	Ep 150 MM	D 10 MM	423866
CO002429	10X230 BOITE DE 50	L 230 MM	Ep 180 MM	D 10 MM	423867
CO002430	10X60 BOITE DE 50	L 60 MM	Ep 10 MM	D 10 MM	423859
CO002431	10X80 BOITE DE 50	L 80 MM	Ep 30 MM	D 10 MM	423860

HRD-CR2

HILTI



Cheville plastique version 10 mm - Tous matériaux version tête fraisée

RÉF. ART.	DESCRIPTION	LON- GUEUR	EPAIS- SEUR	DIAMETRE	REFERENCE FABRICANT
CO002434	10X100 BOITE DE 50	L 100 MM	Ep 50 MM	D 10 MM	423894

photos non contractuelles

HRD-H

HILTI

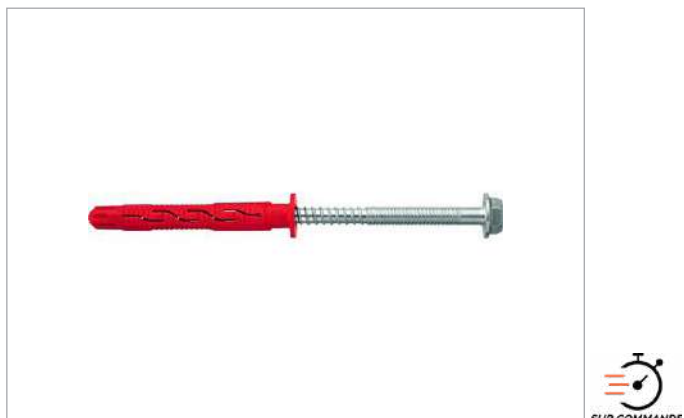

Cheville plastique version 10 mm - Tous matériaux version tête fraisée

RÉF. ART.	DESCRIPTION	LON-GUEUR	EPAIS-SEUR	DIAMETRE	REFERENCE FABRICANT
CO002436	10X100 BOITE DE 50	L 100 MM	Ep 50 MM	D 10 MM	423872
CO002437	10X140 BOITE DE 50	L 140 MM	Ep 90 MM	D 10 MM	423874
CO002438	10X160 BOITE DE 50	L 160 MM	Ep 110 MM	D 10 MM	423875
CO002439	10X180 BOITE DE 50	L 180 MM	Ep 130 MM	D 10 MM	423876
CO002440	10X200 BOITE DE 50	L 200 MM	Ep 150 MM	D 10 MM	423877
CO002441	10X60 BOITE DE 50	L 60 MM	Ep 10 MM	D 10 MM	423870
CO002442	10X80 BOITE DE 50	L 80 MM	Ep 30 MM	D 10 MM	423871

HRD-K

HILTI



Cheville plastique version 10 mm - Tous matériaux version tête fraisée

RÉF. ART.	DESCRIPTION	LON-GUEUR	EPAIS-SEUR	DIAMETRE	REFERENCE FABRICANT
CO002444	10X60 BOITE DE 50	L 60 MM	Ep 10 MM	D 10 MM	423878

HRD-P

HILTI



Cheville plastique version 10 mm - Tous matériaux version tête fraisée

RÉF. ART.	DESCRIPTION	LON-GUEUR	EPAIS-SEUR	DIAMETRE	REFERENCE FABRICANT
CO002445	10X60 BOITE DE 50	L 60 MM	Ep 10 MM	D 10 MM	423883

HRD-UGS

HILTI



Cheville plastique version 10 mm - Tous matériaux version tête fraisée

RÉF. ART.	DESCRIPTION	LON-GUEUR	DIAMETRE	REFERENCE FABRICANT
CO002446	14X110/40 U BOITE DE 50	L 110 MM	Ep 40 MM D 14 MM	312633
CO002447	14X180/110 U BOITE DE 50	L 180 MM	Ep 110 MM D 14 MM	312636
CO002448	14X230/160 U BOITE DE 50	L 230 MM	Ep 160 MM D 14 MM	312638

photos non contractuelles

HRD-UGT



Cheville plastique version 10 mm - Tous matériaux version tête fraisée

RÉF. ART.	DESCRIPTION	LON- GUEUR	DIAME- TRE	REFERENCE FABRICANT
CO002449	14X160/90 BOITE DE 50	L 160 MM	Ep 90 MM D 14 MM	312625
CO002450	14X200/130 BOITE DE 50	L 200 MM	Ep 130 MM D 14 MM	312627
CO002451	14X230/160 BOITE DE 50	L 230 MM	Ep 160 MM D 14 MM	312628

MANOMÈTRE 0-5 KN



RÉF. ART.	DESCRIPTION	REFERENCE FABRICANT
CO014010	C HAT28 EMBALLE	285525

OUTIL DE POSE HPE



Pour chevilles HPE Hilti

RÉF. ART.	DESCRIPTION	REFERENCE FABRICANT
CO003304	HPE-G 10/10 LOT DE 5	373492
CO003310	HPE-M 10/10	373493

PITON D'ÉCHAFAUDAGE GRS



Piton à utiliser avec les chevilles plastiques GD

RÉF. ART.	DESCRIPTION	LONGUEUR	DIAMÈTRE	REFERENCE FABRICANT
CO003581	12/160 BOITE DE 25	L 160 MM	D 12 MM	56420
CO003583	12/90 BOITE DE 25	L 90 MM	D 12 MM	56418

RONDELLE D'ISOLATION HDT



CLOUEUR POUDRE HILTI DX460

Pour appareils DX-A40 XIE et DX 460 muni d'une embase X-IE - pour isolant non autoportant - Diamètre - Epaisseur d'isolants

RÉF. ART.	DESCRIPTION	LONGUEUR	REFERENCE FABRICANT
CO009363	140 BLANC BOITE DE 100	L 140 MM	2107672
CO009364	90 BLANC BOITE DE 100	L 90 MM	2107671

photos non contractuelles

TESTEUR DE CHEVILLES HAT 28 M

HILTI



RÉF. ART.	REFERENCE FABRICANT
CO004245	355338

T-SAVE CHEVILLE A FRAPPER

HILTI



RÉF. ART.	DESCRIPTION	LON- GUEUR	DIAMETRE	REFERENCE FAB- RICANT
CO010644	HTS 8X100-M BL BT DE 100	L 100 MM	D 08 MM	2104736

TETE DE CLOU D'ISOLATION

HILTI



Broche d'isolation

RÉF. ART.	DESCRIPTION	REFERENCE FABRICANT
CO004250	IDMS-T BOITE DE 250	65759
CO004251	IDT BOITE DE 250	65621

VIS D'ANCRAGE HUS

HILTI

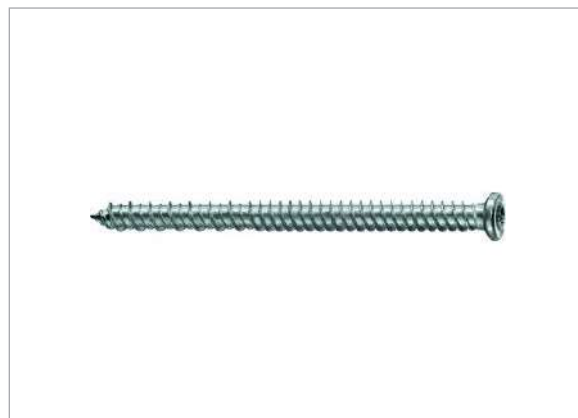

Vis d'ancrage pour fixation rapide à tête plate ronde - Diamètre X longueur de la vi

RÉF. ART.	DESCRIPTION	LONGUEUR	DIAMETRE	REFERENCE FABRI- CANT
CO004635	6X100 BOITE DE 100	L 100 MM	D 06 MM	381402
CO004636	6X120 BOITE DE 100	L 120 MM	D 06 MM	381403
CO004637	6X140 BOITE DE 100	L 140 MM	D 06 MM	381404
CO004638	6X160 BOITE DE 100	L 160 MM	D 06 MM	381405
CO004639	6X180 BOITE DE 100	L 180 MM	D 06 MM	383050
CO004643	6X35 BOITE DE 100	L 35 MM	D 06 MM	383047
CO004644	6X55 BOITE DE 100	L 45 MM	D 06 MM	383048
CO004645	6X60 BOITE DE 100	L 60 MM	D 06 MM	383049
CO004646	6X80 BOITE DE 100	L 80 MM	D 06 MM	381401

VIS D'ANCRAGE HUS2-H



RÉF. ART.	DESCRIPTION	REFERENCE FABRICANT
CO105721	10x105 50/30 - LOT DE 50	2246438
CO105722	10x60 5/- - LOT DE 50	2246794
CO105723	10x85 30/10 - LOT DE 50	2246795
CO105724	10x95 40/20 - LOT DE 50	2246437
CO105725	8x55 5/- - LOT DE 50	2246790
CO105726	8x75 25/10 - LOT DE 50	2246791
CO105727	8x85 35/20 - LOT DE 50	2246792
CO105728	8x95 45/30 - LOT DE 50	2246793

VIS D'ANCRAGE HUS3-A



RÉF. ART.	DESCRIPTION	LONGUEUR	DIAMETRE	REFERENCE FABRICANT
CO020596	6X175 120/140 M8/16	L 175 MM	D 06 MM	2120025

VIS D'ANCRAGE HUS3-C



Vis d'ancrage pour fixation rapide à tête plate ronde - Réutilisable après contrôle avec gabarit

RÉF. ART.	DESCRIPTION	LON- GUEUR	Ep	DIAME- TRE	REFERENCE FABRICANT
CO008560	10X100 45/25/15 BOITE DE 50	L 100 MM	Ep 45 MM	D 10 MM	2079936
CO008561	10X70 15/-/- BOITE DE 50	L 70 MM	Ep 15 MM	D 10 MM	2079934
CO008562	10X90 35/15/- BOITE DE 50	L 90 MM	Ep 35 MM	D 10 MM	2079935
CO010109	6X60 /5/15 BOITE DE 100	L 60 MM	Ep 5 MM	D 06 MM	2119775
CO010110	6X70 /15/35 BOITE DE 100	L 70 MM	Ep 15 MM	D 06 MM	2119776
CO008563	8X65 15/-/- BOITE DE 50	L 65 MM	Ep 15 MM	D 08 MM	2079931
CO008564	8X75 25/15/- BOITE DE 50	L 75 MM	Ep 25 MM	D 08 MM	2079932
CO008565	8X85 35/25/15 BOITE DE 50	L 85 MM	Ep 35 MM	D 08 MM	2079933

photos non contractuelles

VIS D'ANCRAGE HUS3-H

HILTI



Vis d'ancrage pour fixation rapide à tête plate ronde - Réutilisable après contrôle avec gabarit

RÉF. ART.	DESCRIPTION	LON- GUEUR	DIAMÈ- TRE	REFERENCE FABRICANT
CO009794	6X40/5/ SEAU 500 PCES	L 40 MM	Ep 05 MM D 06 MM	428664
CO008624	10X100 45/25/15 BOITE DE 50	L 100 MM	Ep 45 MM D 10 MM	2079915
CO008625	10X110 55/35/25 BOITE DE 50	L 110 MM	Ep 55 MM D 10 MM	2079916
CO008626	10X130 75/55/45 BOITE DE 50	L 130 MM	Ep 75 MM D 10 MM	2079917
CO008627	10X150 95/75/65 BOITE DE 50	L 150 MM	Ep 95 MM D 10 MM	2079918
CO008628	10X60 5/-/- BOITE DE 50	L 60 MM	Ep 5 MM D 10 MM	2079911
CO008629	10X70 15/-/- BOITE DE 50	L 70 MM	Ep 15 MM D 10 MM	2079912
CO008630	10X80 25/5/- BOITE DE 50	L 80 MM	Ep 25 MM D 10 MM	2079913
CO008572	10X90 35/15/5 BOITE DE 50	L 90 MM	Ep 35 MM D 10 MM	2079914
CO008631	14X100 35/15/- BOITE DE 16	L 100 MM	Ep 35 MM D 14 MM	2079922
CO008632	14X130 65/45/15 BOITE DE 16	L 130 MM	Ep 65 MM D 14 MM	2079923
CO008633	14X150 85/65/35 BOITE DE 16	L 150 MM	Ep 85 MM D 14 MM	2079924
CO008634	14X75 10/-/- BOITE DE 16	L 75 MM	Ep 10 MM D 14 MM	2079921
CO008635	8X100 50/40/30 BOITE DE 50	L 100 MM	Ep 50 MM D 08 MM	2079798
CO008573	8X120 70/60/50 BOITE DE 50	L 120 MM	Ep 70 MM D 08 MM	2079799
CO008574	8X150 100/90/80 BOITE DE 50	L 150 MM	Ep 100 MM D 08 MM	2079910
CO008636	8X55 5/-/- BOITE DE 50	L 55 MM	Ep 05 MM D 08 MM	2079794
CO008637	8X65 15/5/- BOITE DE 50	L 65 MM	Ep 15 MM D 08 MM	2079795
CO008638	8X75 25/15/5 BOITE DE 50	L 75 MM	Ep 25 MM D 08 MM	2079796
CO008639	8X85 35/25/15 BOITE DE 50	L 85 MM	Ep 35 MM D 08 MM	2079797

VIS D'ANCRAGE HUS3-HF

HILTI

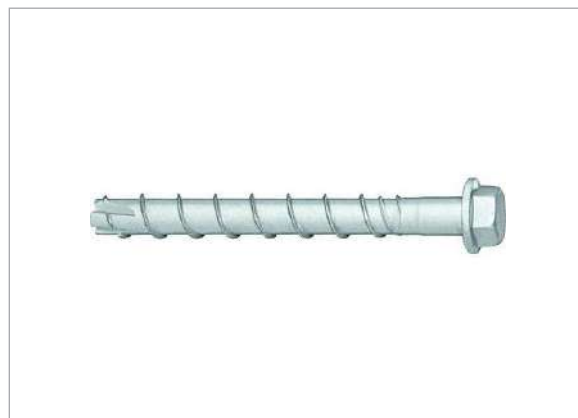

Vis d'ancrage pour fixation rapide à tête plate ronde - Réutilisable après contrôle avec gabarit

RÉF. ART.	DESCRIPTION	LON- GUEUR	DIAMÈ- TRE	REFERENCE FABRICANT
CO008575	10X100 45/25/15 BOITE DE 50	L 100 MM	Ep 45 MM D 10 MM	2079927
CO008576	10X110 55/35/25 BOITE DE 50	L 110 MM	Ep 55 MM D 10 MM	2079928
CO008577	10X60 5/-/- BOITE DE 50	L 60 MM	Ep 05 MM D 10 MM	2079925
CO008578	10X80 25/5/- BOITE DE 50	L 80 MM	Ep 25 MM D 10 MM	2079926
CO008579	14X100 35/15/- BOITE DE 16	L 100 MM	Ep 35 MM D 14 MM	2079930
CO008580	14X75 10/-/- BOITE DE 16	L 75 MM	Ep 75 MM D 14 MM	2079929

VIS D'ANCRAGE HUS3-I

HILTI



RÉF. ART.	DESCRIPTION	LON- GUEUR	DIAMÈTRE	REFERENCE FAB- RICANT
CO015171	6X35 M8/M10 LOT DE 100	L 35 MM	D 06 MM	416740
CO019009	I FLEX 6X35 M6 - LOT DE 100			2119777

photos non contractuelles

VIS D'ANCRAGE HUS3-P



Vis d'ancrage pour fixation rapide à tête plate ronde - Réutilisable après contrôle avec gabarit

RÉF. ART.	DESCRIPTION	LON- GUEUR	DIAMETRE	REFERENCE FAB- RICANT
CO010052	6X40/5/ BOITE DE 100	L 40 MM	D 06 MM	416745
CO009982	6X40/5/ SEAU 500 PCES	L 40 MM	D 06 MM	428663
CO010246	6X80/25/45 BOITE DE 100	L 80 MM	D 06 MM	416747

VIS D'ANCRAGE HUS3-PS



Vis d'ancrage pour fixation rapide à tête plate ronde - Réutilisable après contrôle avec gabarit

RÉF. ART.	DESCRIPTION	LONGUEUR	DIAMETRE	REFERENCE FAB- RICANT
CO010106	6X40/5 BOITE DE 100	L 40 MM	D 06 MM	2119772
CO010107	6X60/5/25 BOITE DE 100	L 60 MM	D 06 MM	2119773

VIS D'ANCRAGE HUS-CR



Vis d'ancrage pour fixation rapide à tête plate ronde - Réutilisable après contrôle avec gabarit

RÉF. ART.	DESCRIPTION	LON- GUEUR	DIAMETRE	REFERENCE FABRICANT
CO008566	10X105 45/35/15 BOITE DE 25	L 105 MM	Ep 45 MM D 10 MM	2082436
CO008568	10X85 25/15/- BOITE DE 25	L 85 MM	Ep 25 MM D 10 MM	2082435
CO008570	8X75 25/15/- BOITE DE 25	L 75 MM	Ep 25 MM D 08 MM	2082432

VIS D'ANCRAGE HUS-H



Vis d'ancrage haute performance

RÉF. ART.	DESCRIPTION	LON- GUEUR	DIAMETRE	REFERENCE FABRICANT
CO010426		L 240 MM	Ep 180 MM D 10 MM	368743
CO008946	6X40/5 BOITE DE 100	L 40 MM	Ep 05 MM D 06 MM	416735
CO004671	6X60/5/25 (remplace H273659)	L 60 MM	Ep 05 MM D 06 MM	416736
CO004662	6X80/25/45 (remplace H273663)	L 80 MM	Ep 45 MM D 06 MM	416737

photos non contractuelles

VIS D'ANCRAGE HUS-HF

HILTI



RÉF. ART.	DESCRIPTION	LON- GUEUR	DIAMETRE	REFERENCE FAB- RICANT
CO018641	8X65 15/05/ BOITE DE 50 GALVA	L 65 MM	D 08 MM	2108735

VIS D'ANCRAGE HUS-HR

HILTI



Vis d'ancrage inox haute performance - Diamètre X longueur de la vis - tête hexagonale

RÉF. ART.	DESCRIPTION	LON- GUEUR	DIAMETRE	REFERENCE FABRICANT
CO004681	10X105/15/35/45 BOITE DE 25	L 105 MM	Ep 45 MM D 10 MM	290072
CO004682	10X115/25/45/55 BOITE DE 25	L 115 MM	Ep 55 MM D 10 MM	290131
CO004683	10X130/40/60/70 BOITE DE 25	L 130 MM	Ep 70 MM D 10 MM	290161
CO004684	10X75/5/15 BOITE DE 25	L 75 MM	Ep 15 MM D 10 MM	290063
CO004685	10X85/15/25 BOITE DE 25	L 85 MM	Ep 25 MM D 10 MM	290067
CO004686	10X95/5/25/35 BOITE DE 25	L 95 MM	Ep 35 MM D 10 MM	290068
CO004687	14X120/10/50 BOITE DE 12 -	L 120 MM	Ep 50 MM D 14 MM	290182
CO004688	14X135/25/65 BOITE DE 12	L 135 MM	Ep 65 MM D 14 MM	290183
CO004689	6X60/5/30 BOITE DE 50	L 60 MM	Ep 30 MM D 06 MM	290014
CO004690	6X70/15/40 BOITE DE 50	L 70 MM	Ep 40 MM D 06 MM	290015
CO004691	8X105/25/45/55 BOITE DE 20	L 105 MM	Ep 55 MM D 08 MM	290034
CO004692	8X65/5/15 BOITE DE 25	L 65 MM	Ep 15 MM D 08 MM	290030
CO004693	8X75/15/25 BOITE DE 25	L 75 MM	Ep 25 MM D 08 MM	290031
CO004694	8X85/5/25/35 BOITE DE 25	L 85 MM	Ep 35 MM D 08 MM	290032
CO004695	8X95X15/35/45 BOITE DE 20 -	L 95 MM	Ep 45 MM D 08 MM	290033
CO004696	10X65/5 BOITE DE 25	L 65 MM	Ep 05 MM D 10 MM	290062
CO004697	14X80/10 BOITE DE 12	L 80 MM	Ep 10 MM D 14 MM	290181
CO004698	6X35/5 BOITE DE 50 -	L 35 MM	Ep 05 MM D 06 MM	290005
CO004699	6X45/15 BOITE DE 50	L 45 MM	Ep 15 MM D 06 MM	290011
CO004700	8X55/5 BOITE DE 25	L 55 MM	Ep 05 MM D 08 MM	290029

VIS D'ANCRAGE HUS-I



Vis d'ancrage pour fixation rapide à tête plate ronde - Réutilisable après contrôle avec gabarit

RÉF. ART.	DESCRIPTION	LON- GUEUR	DIAMETRE	REFERENCE FAB- RICANT
CO010148	6x35 M8/M10 SEAU DE 300	L 35 MM	D 06 MM	428662
CO009222	6x55 M8/M10 BOITE 100	L 55 MM	D 06 MM	423180

VIS HEX. PART. FILETEE HDS



RÉF. ART.	DESCRIPTION	LON- GUEUR	DIAMETRE	REFERENCE FAB- RICANT
CO015185	-HEX-SKT 8X60 LOT DE 100	L 60 MM	D 08 MM	2054144

VIS TÊTE

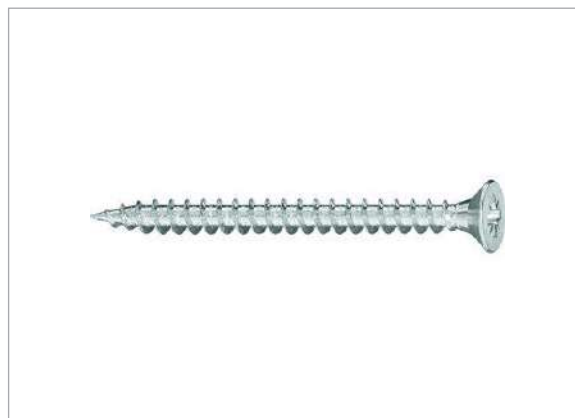

RÉF. ART.	DESCRIPTION	REFERENCE FABRICANT
CO016712	FR.,EMPR.CRUC HDS-C-PZ 5X55 LOT DE 200	2054140
CO016715	FRAIS.TORX HDS-C-TX 7X60 LOT DE 100	2054143

ANNEAU D'ANCRAGE



RÉF. ART.	DESCRIPTION	DIAMETRE
CO006530	D.14 A2 SPIT	D 14 MM

photos non contractuelles

CHEVILLE ARPON



CHEVILLE PLASTIQUE POUR LE CREUX

RÉF. ART.	DESCRIPTION	LON- GUEUR	DIAMETRE	REFERENCE FAB- RICANT
CO007020	ARPON 6 VRAC BOITE DE 4000	L 25 MM	D 06 MM	71100
CO007219	6 BOITE DE 100	L 25 MM	D 06 MM	198160
CO007220	8 PAV BOITE DE 100	L 32 MM	D 08 MM	
CO007021	ARPON 8 VRAC BOITE DE 4000	L 32 MM	D 08 MM	71110

CB 8X95/50-60 T90



RÉF. ART.	LONGUEUR	EPAIS- SEUR	DIAMETRE	REFERENCE FABRICANT
CO010698	L 95 MM	Ep 60 MM	D 08 MM	57691

CHEVILLE HITM 6-5 M



Cheville clou pour fixation légère dans tous matériaux

RÉF. ART.	DESCRIPTION	LON- GUEUR	DIAMETRE	REFERENCE FABRICANT
CO006390	7X150 SPIT BOITE DE 100	L 32 MM	Ep 05 MM D 06 MM	50142

CHEVILLE B-LONG TETE FRAISEE



Cheville cadre très grande longueur multi-matériaux. version tête fraisée

RÉF. ART.	DESCRIPTION	LON- GUEUR	DIAMETRE	REFERENCE FABRICANT
CO017106	10x120/70 F BOITE DE 50	L 120 MM	Ep 70 MM D 10 MM	567959
CO009988	10X120/70 HS BOITE DE 50	L 120 MM	Ep 70 MM D 10 MM	567972
CO018345	10X140/90 F			567960
CO008944	10X80/30 BOITE DE 50	L 80 MM	Ep 30 MM D 10 MM	567970
CO017082	8x120/70 F BOITE DE 50	L 120 MM	Ep 70 MM D 08 MM	567953

photos non contractuelles

CHEVILLE B-LONG TETE HEX



RÉF. ART.	DESCRIPTION	LON-GUEUR	DIAMETRE	REFERENCE FABRICANT
CO018317	10x140/90HS T.HEX			567973
CO010714	XTREM 10x100/50 HS T.HEX	L 100 MM	Ep 50 MM D 10 MM	567971

CHEVILLE CB 8



POUR ISOLANT SEMI RIGIDE EPAISSEUR : 110/120

RÉF. ART.	DESCRIPTION	LON-GUEUR	DIAMETRE	REFERENCE FABRICANT
CO006765	110/120 TETE90MM NORME CSTB EN BOITE DE 200	L 155 MM	Ep 120 MM D 08 MM	55740
CO006761	90/100 TETE DE 90 MM NORME CSTB BOITE DE 200	L 135 MM	Ep 100 MM D 08 MM	55730

CHEVILLE CC

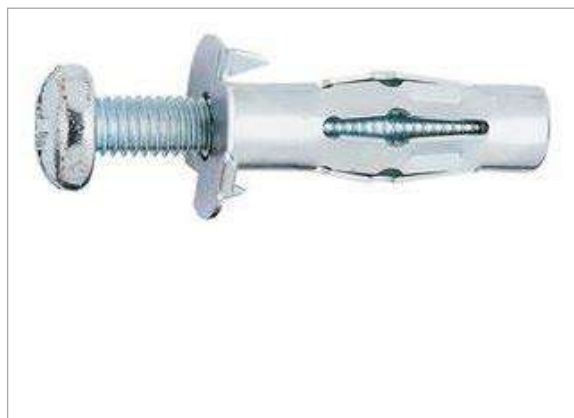

CHEVILLE METAL AVEC VIS POUR CLOISONS CREUSES

RÉF. ART.	DESCRIPTION	LON-GUEUR	DIAMETRE	REFERENCE FABRICANT
CO006956	5-16/45AV BOITE DE 100	L 45 MM	Ep 25 MM D 08 MM	61080
CO006957	5-32 / 59 AV BOITE DE 100	L 59 MM	Ep 25 MM D 08 MM	61090
CO006959	6-16 / 46 AV BOITE DE 100	L 46 MM	Ep 28 MM D 10 MM	61120
CO006960	6-30 / 59 AV BOITE DE 100	L 59 MM	Ep 27 MM D 10 MM	61130

CHEVILLE DRIVA

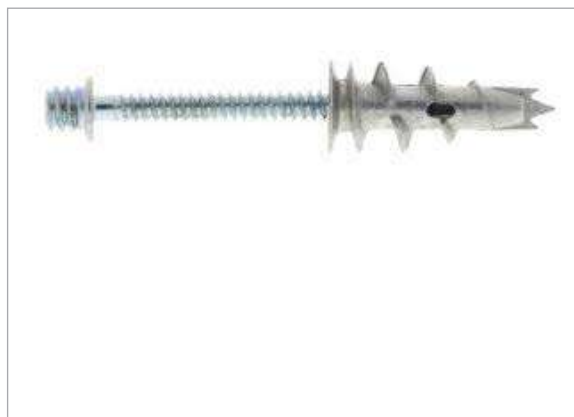

POUR FIXATION LEGERE DANS PLACO OU BRIQUETTE

RÉF. ART.	DESCRIPTION	LON-GUEUR	DIAMETRE	REFERENCE FABRICANT
CO006931	C7 BOITE DE 100	L 31 MM	Ep 05 MM D 14 MM	59390
CO007539	CLICK TP 10 BOITE DE 100	L 38 MM	Ep 10 MM D 14 MM	565806
CO006930	TF 27 BOITE DE 100	L 31 MM	Ep 27 MM D 14 MM	59380
CO006928	TP12 BOITE DE 100	L 31 MM	Ep 12 M D 14 MM	59360
CO007023	TP12 BOITE DE 200	L 31 MM	Ep 12 MM D 14 MM	74180

photos non contractuelles

CHEVILLE FIX



Cheville à expansion par vissage rondelle et écrou montés, ATE option 1 pour béton fissuré, Inox A4

RÉF. ART.	DESCRIPTION	LONGUEUR	DIAMETRE	REFERENCE FABRICANT
CO006801	6 PERCEE/64	L 64 MM	D 06 MM	56100
CO006647	6x55/15 A4 MT	L 55 MM	D 06 MM	54270

CHEVILLE FIX III



Cheville à expansion par vissage rondelle et écrou montés, ATE option 7 pour béton non fissuré

RÉF. ART.	DESCRIPTION	LON- GUEUR	DIAMETRE	REFERENCE FABRICANT
CO006853	8X55/5 MONTEES BOITE DE 100	L 55 MM	Ep 5 MM D 08 MM	57450
CO006854	8X70/20-10 MONTEES BOITE DE 100 *	L 70 MM	Ep 20 MM D 08 MM	57451
CO006855	8X90/40-30 MONTEES BTE DE 50	L 90 MM	Ep 40 MM D 08 MM	57452
CO006856	8X100/50-40 MONTEES BTE DE 50	L 100 MM	Ep 50 MM D 08 MM	57453
CO006857	8X115/55 MONTEES BOITE DE 50 *	L 115 MM	Ep 55 MM D 08 MM	57454
CO006858	8X130/80-70 MONTEES BOITE DE 50	L 130 MM	Ep 70 MM D 08 MM	57455
CO006859	8X160/110-100 MONTEES BTE DE 50	L 160 MM	Ep 110 MM D 08 MM	57456
CO006860	10X65/5 MONTEES BOITE DE 50 *	L 65 MM	Ep 5 MM D 10 MM	57460
CO006861	10X75/15-5 MONTEES BOITE DE 50 *	L 75 MM	Ep 15 MM D 10 MM	57461
CO006868	12X80/5 MONTEES BOITE DE 25 *	L 80 MM	Ep 5 MM D 12 MM	57470
CO006862	10X95/36-26 MONTEES BOITE DE 50 *	L 95 MM	Ep 36 MM D 10 MM	57463
CO006863	10X110/50-40 MONTEES BOITE DE 50 *	L 110 MM	Ep 50 MM D 10 MM	57464
CO006864	10X125/65-55 MONTEES BOITE DE 25 *	L 125 MM	Ep 65 MM D 10 MM	57465
CO006865	10X140/80-70 MONTEES BOITE DE 25 *	L 140 MM	Ep 80 MM D 10 MM	57466
CO006866	10X160/100-90 MONTEES BOITE DE 25 *	L 160 MM	Ep 100 MM D 10 MM	57467
CO006869	12X100/25-10 MONTEES BOITE DE 25	L 100 MM	Ep 25 MM D 12 MM	57471
CO006870	12X115/40-25 MONTEES BOITE DE 25 *	L 115 MM	Ep 40 MM D 12 MM	57472
CO006871	12X125/50-35 MONTEES BOITE DE 25 *	L 125 MM	Ep 50 MM D 12 MM	57473
CO007549	12X140/65-50 MONTEES BOITE DE 25 *	L 140 MM	Ep 65 MM D 12 MM	57474
CO006873	12X180/105-90 MONTEES BOITE DE 25 *	L 180 MM	Ep 105 MM D 12 MM	57576
CO006874	12X220/145-130 MONTEES BOITE DE 25 *	L 220 MM	Ep 145 MM D 12 MM	57477
CO006875	12X290/215-200 MONTEES BOITE DE 25 *	L 290 MM	Ep 215 MM D 12 MM	57478
CO006876	16X100/5-0 MONTEES BOITE DE 20*	L 100 MM	Ep 5 MM D 16 MM	57480
CO006877	16X125/30-15 MONTEES BOITE DE 25 *	L 125 MM	Ep 30 MM D 16 MM	57481
CO006878	16X150/55-40 MONTEES BOITE DE 10 *	L 150 MM	Ep 55 MM D 16 MM	57482
CO006879	16-170/75 -60 MONTEES BTE DE 10	L 170 MM	Ep 75 MM D 16 MM	57483
CO006880	16X185/90-75 MONTEES BOITE DE 10 *	L 185 MM	Ep 90 MM D 16 MM	57484

photos non contractuelles

»

RÉFÉRENCE	ARTICLE	DESCRIPTION	LON- GUEUR	DIAME- TRE	
CO006881	16X235/140-125	MONTEES BOITE DE 10 *	L 235 MM	Ep 140 MM D 16 MM	57485
CO006882	16X300/205-190	MONTEES BOITE DE 10 *	L 300 MM	Ep 205 MM D 16 MM	57486
CO006883	20X125/10	MONTEES BOITE DE 10 *	L 125 MM	Ep 10 MM D 20 MM	57490
CO006884	20X165/50-25	MONTEES BOITE DE 10 *	L 165 MM	Ep 50 MM D 20 MM	57491
CO006885	20X220/105-80	MONTEES BOITE DE 10 *	L 220 MM	Ep 105 MM D 20 MM	57492

CHEVILLE FIX Z



Cheville à expansion par vissage rondelle et écrou montés, ATE option 1 pour béton fissuré, Inox A23

RÉF. ART.	DESCRIPTION	LON- GUEUR	DIAME- TRE	REFERENCE FABRICANT
CO006421	8X55/5 A4 MT BOITE DE 100	L 55 MM	Ep 05 MM D 08 MM	50441
CO006683	8X70/20 A4 MT BOITE DE 100	L 70 MM	Ep 20 MM D 08 MM	54610
CO006721	8X90/40 A4 MT BOITE DE 50	L 90 MM	Ep 40 MM D 08 MM	55343
CO006408	8X130/80 A4 MT BOITE DE 50	L 130 MM	Ep 80 MM D 08 MM	50367
CO006684	10-75/15 INOX A4 EN BOITE DE 50	L 75 MM	Ep 15 MM D 10 MM	54630
CO006422	10X120/60 A4 MT BOITE DE 25	L 120 MM	Ep 60 MM D 10 MM	50442
CO006426	10X65/5 A4 MT BOITE DE 50	L 65 MM	Ep 05 MM D 10 MM	50466
CO006685	10X95/35 A4 MT BOITE DE 50	L 95 MM	Ep 35 MM D 10 MM	54640
CO006722	12X80/5 A4 MT BOITE DE 25	L 80 MM	Ep 05 MM D 12 MM	55344
CO006723	12X100/25 A4 MT BOITE DE 25	L 100 MM	Ep 25 MM D 12 MM	55345
CO006733	12X115/40 A4 MT BOITE DE 25	L 115 MM	Ep 40 MM D 12 MM	55394
CO006686	12X140/65 A4 MT BOITE DE 25	L 140 MM	Ep 65 MM D 12 MM	54680
CO006423	16X125/30 A4 MT BOITE DE 25	L 125 MM	Ep 30 MM D 16 MM	50443
CO006687	16X150/55 A4 MT BOITE DE 10	L 150 MM	Ep 55 MM D 16 MM	54700
CO006424	16X170/75 A4 MT BOITE DE 10	L 170 MM	Ep 75 MM D 16 MM	50444

CHEVILLE GRIP L



Cheville femelle à cône intérieur avec collerette, ATE option 7, diamètre de perçement

RÉF. ART.	DESCRIPTION	LONGUEUR	DIAMETRE	REFERENCE FABRI- CANT
CO006478	M 10X40	L 43 MM	D 10 MM	50791
CO006479	M 12X50	L 54 MM	D 12 MM	50792
CO006480	M 16X65	L 70 MM	D 16 MM	50793
CO006476	M 6X30	L 32 MM	D 06 MM	50789
CO006477	M 8X30	L 33 MM	D 08 MM	50790
CO006481	M10X30	L 43 MM	D 10 MM	50799

CHEVILLE GRIP M



Cheville femelle à cône intérieur sans collerette, ATE option 7, diamètre de perçement

RÉF. ART.	DESCRIPTION	LON- GUEUR	DIAMETRE	REFERENCE FAB- RICANT
CO006976	M 10X40 INOX A4 BOITE DE 50	L 40 MM	D 10 MM	62260

photos non contractuelles

CHEVILLE GRIP S M



Chevilles femelle haute résistance à expansion par frappe

RÉF. ART.	DESCRIPTION	LON- GUEUR	DIAMETRE	REFERENCE FAB- RICANT
CO006972	12X50 BOITE DE 50	L 50 MM	D 12 MM	62070
CO006973	16X65 BOITE DE 20	L 65 MM	D 16 MM	62080
CO006969	6X30 BOITE DE 100	L 30 MM	D 06 MM	62040
CO006974	6X30 INOX A4 BOITE DE 100	L 30 MM	D 06 MM	62240
CO006970	8X30 BOITE DE 100	L 30 MM	D 08 MM	62050
CO006975	8X30 INOX A4 BOITE DE 100	L 30 MM	D 08 MM	62250
CO006971	10X40 BOITE DE 100	L 40 MM	D 10 MM	62060
CO006968	7X30	L 30 MM	D 07 MM	61980
CO006977	12X50 INOX A4 BOITE DE 50	L 50 MM	D 12 MM	62270
CO006978	16X65 INOX A4 BOITE DE 25	L 65 MM	D 16 MM	62280

CHEVILLE HIT A FRAPPER



Chevilles clou pour fixation légère dans tous matériaux

RÉF. ART.	DESCRIPTION	LON- GUEUR	DIAMETRE	REFERENCE FAB- RICANT
CO006375	6-25/52 P EN BOITE DE 100	L 52 MM	Ep 25 MM D 06 MM	50121
CO006372	5-5/27 P EN BOITE DE 200	L 27 MM	Ep 05 MM D 05 MM	50116
CO006376	6-40/67 P EN BOITE DE 100	L 67 MM	Ep 40 MM D 06 MM	50122
CO006373	6-5/32 P EN BOITE DE 200	L 32 MM	Ep 05 MM D 06 MM	50118

photos non contractuelles

CHEVILLE HITM



Chevilles clou pour fixation légère dans tous matériaux

RÉF. ART.	DESCRIPTION	LON- GUEUR	DIAMETRE	REFERENCE FAB- RICANT
CO007500	5-15/37 P BOITE DE 200	L 37 MM	Ep 15 MM D 05 MM	50117
CO006382	6-12/37 V SPIT BOITE DE 100	L 37 MM	Ep 12 MM D 06 MM	50129
CO006374	6-12/39 P SPIT BOITE DE 100	L 39 MM	Ep 12 MM D 06 MM	50119
CO006383	6-25/50 V SPIT BOITE DE 100	L 50 MM	Ep 25 MM D 06 MM	50131
CO006384	6-40/65 V SPIT BOITE DE 100	L 65 MM	Ep 40 MM D 06 MM	50132
CO006730	8-10/42 P20 BOITE DE 100	L 42 MM	Ep 10 MM D 08 MM	55378
CO008510	8-110/80PV			60093
CO009625	8-60/30 V SPIT BOITE DE 50	L 62 MM	Ep 30 MM D 08 MM	60095
CO009626	8-90/60 V SPIT BOITE DE 50	L 92 MM	Ep 60 MM D 08 MM	60096
CO008512	8-90/60P			60092
CO006905	8x125/158 VETURE jusqu'à épuisement	L 125 MM	Ep 158 MM D 08 MM	57601
CO006906	8x145/178 VETURE jusqu'à épuisement	L 145 MM	Ep 178 MM D 08 MM	57602
CO006907	8x165/188 VETURE jusqu'à épuisement	L 165 MM	Ep 188 MM D 08 MM	57603
CO009627	8X40/10P A2 SPIT BOITE DE 50	L 42 MM	Ep 10 MM D 08 MM	60107
CO009628	8X60/30P A2 SPIT BOITE DE 50	L 62 MM	Ep 30 MM D 08 MM	60108
CO009629	8X90/60P A2 SPIT BOITE DE 50	L 92 MM	Ep 60 MM D 08 MM	60109
CO010708	5X25/5P BID/1000	L 27 MM	Ep 05 MM D 05 MM	55703
CO010709	6X30/5P BID/1000	L 32 MM	Ep 05 MM D 06 MM	55704

CHEVILLE ISOMET



TENUE AU FEU (CSTB) EPAISSEUR MAXI

RÉF. ART.	DESCRIPTION	LON- GUEUR	DIAME- TRE	REFERENCE FABRICANT
CO006942	8-120/170 TETE 35MM BOITE DE 250	L 170 MM	Ep 120 MM D 08 MM	59760
CO017022	8-140 TETE 35MM BOITE DE 250	L 140 MM	Ep 90 MM D 08 MM	59750
CO006943	8-150/200 BOITE DE 250	L 200 MM	Ep 150 MM D 08 MM	59770
CO006939	8-30/80 TETE DE 35 MM EN BOITE DE 250	L 80 MM	Ep 30 MM D 08 MM	59730
CO006940	8-60/110 TETE DE 35 MM EN BOITE DE 250	L 110 MM	Ep 60 MM D 08 MM	59740
CO006947	8-70/120 TETE DE 35 MM EN BOITE DE 250	L 120 MM	Ep 70 MM D 08 MM	59880

CHEVILLE NYLON

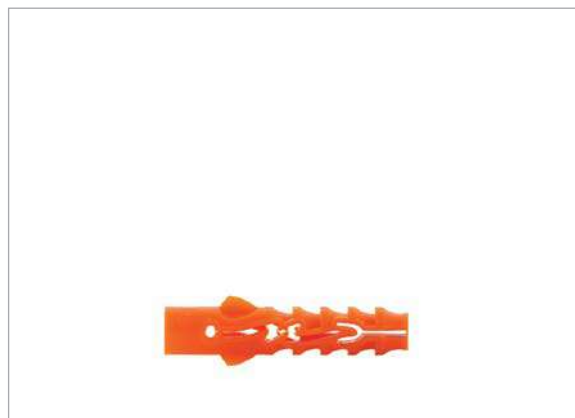

POUR FIXATION LEGERE

RÉF. ART.	DESCRIPTION	LON- GUEUR	DIAMETRE	REFERENCE FABRICANT
CO008012	SANS COL BOITE DE 100	L 40 MM	D 08 MM	57020
CO006838	SANS COL BOITE DE 50	L 50 MM	D 10 MM	57030
CO006843	SANS COL BOITE DE 25	L 60 MM	D 12 MM	57150
CO006839	SANS COL BOITE DE 20	L 70 MM	D 14 MM	57050
CO006840	AVEC COL BOITE DE 100	L 25 MM	D 05 MM	57070
CO006841		L 30 MM	D 06 MM	57080
CO010668	AVEC COL BIDON DE 300	L 40 MM	Ep 40 MM D 08 MM	55717
CO006842	AVEC COL BOITE DE 100	L 40 MM	D 08 MM	57090

photos non contractuelles

CHEVILLE PRIMA LM



50404 - CHEVILLE TOUS MATERIAUX A EXPANSION MAXI ECROUS ET RONDELLES CLASSE 8.8 MONTES - 25

RÉF. ART.	DESCRIPTION	LON- GUEUR	DIAME- TRE	REFERENCE FABRICANT
CO006415	6-12/10 BOITE DE 25	L 60 MM	Ep 10 MM D 06 MM	50404
CO006416	6-12/25 BOITE DE 25	L 60 MM	Ep 25 MM D 06 MM	50405
CO008862	8-14/10 COL. BOITE DE 25		Ep 10 MM D 08 MM	50406
CO006418	8-14/25 BOITE DE 25	L 65 MM	Ep 25 MM D 08 MM	50407 -
CO006419	8-14/40 BOITE DE 25	L 65 MM	Ep 40 MM D 08 MM	50408

CHEVILLE PRIMA



CHEVILLE TOUS MATERIAUX A EXPANSION MAXI ECROUS ET RONDELLES CLASSE 8.8 MONTES

RÉF. ART.	DESCRIPTION	LONGUEUR	DIAMETRE	REFERENCE FAB- RICANT
CO006414	M10 D.16 COL. SANS VIS	L 75 MM	D 10 MM	50402
CO006412	M6 D.12 COL. SANS VIS	L 60 MM	D 06 MM	50399
CO006413	M8 D.14 COL. SANS VIS	L 65 MM	D 08 MM	50401

CHEVILLE PRO 6 AVEC VIS



CHEVILLE PASTIQUE AVEC VIS POUR FIXATIONS LEGERES TOUS SUPPORTS

RÉF. ART.	DESCRIPTION	LON- GUEUR	DIAME- TRE	REFERENCE FABRICANT
CO007538	10X50 A/VIS BOITE DE 25	L 50 MM	Ep 05 MM D 10 MM	565649
CO007535	5X25 A/VIS BOITE DE 100	L 25 MM	Ep 02 MM D 05 MM	565646
CO007536	5X30 A/VIS BOITE DE 100	L 30 MM	Ep 05 MM D 06 MM	565647
CO007537	8X40 A/VIS BOITE DE 50	L 40 MM	Ep 05 MM D 08 MM	565648

CHEVILLE PRO 6 SANS VIS



CHEVILLE PASTIQUE AVEC VIS POUR FIXATIONS LEGERES TOUS SUPPORTS

RÉF. ART.	DESCRIPTION	LON- GUEUR	DIAME- TRE	REFERENCE FABRICANT
CO007534	10X50 SS/VIS BOITE DE 50	L 50 MM	Ep 05 MM D 10 MM	565645
CO007529	12X60 SS/VIS BOITE DE 25	L 60 MM	Ep 05 MM D 12 MM	565617
CO007530	14X70 SS/VIS BOITE DE 20	L 70 MM	Ep 05 MM D 14 MM	565618
CO007531	5X25 SS/VIS BOITE DE 100	L 25 MM	Ep 02 MM D 05 MM	565642
CO007532	6X30 SS/VIS BOITE DE 100	L 30 MM	Ep 05 MM D 06 MM	565643
CO007533	8X40 SS/VIS BOITE DE 100	L 40 MM	Ep 05 MM D 08 MM	565644

photos non contractuelles

CHEVILLE TRIGA Z E



Cheville Haute Performance pour charges très élevées version écrou zinguée

RÉF. ART.	DESCRIPTION	LON- GUEUR	DIAME- TRE	REFERENCE FABRICANT
CO006452	10-15/20 BOITE DE 25	L 90 MM	Ep 20 MM D 10 MM	50691
CO006453	10-15/35 BOITE DE 25	L 90 MM	Ep 35 MM D 10 MM	50692
CO006454	10-15/55 BOITE DE 25	L 90 MM	Ep 55 MM D 10 MM	50693
CO006460	12-18/45 BOITE DE 20	L 105 MM	Ep 45 MM D 12 MM	50699
CO006463	12-18/A BOITE DE 10	L 105 MM	D 12 MM	50703
CO006468	16-24 / 100 BOITE DE 5	L 130 MM	Ep 100 MM D 16 MM	50708 -
CO006473	20-28/100 BOITE DE 5	L 160 MM	Ep 100 MM D 20 MM	50714
CO006471	20-28/25 BOITE DE 5	L 160 MM	Ep 25 MM D 20 MM	50712
CO006472	20-28/60 BOITE DE 5	L 160 MM	Ep 60 MM D 20 MM	50713
CO006446	8-12/55 BOITE DE 50	L 80 MM	Ep 55 MM D 08 MM	50684
CO006447	8-12/95 BOITE DE 25	L 80 MM	Ep 95 MM D 08 MM	50685
CO006462	12-18/100 BOITE DE 20	L 105 MM	Ep 100 MM D 12 MM	50702
CO006459	12-18/25 BOITE DE 25	L 105 MM	Ep 25 MM D 12 MM	50698
CO006436	12-18/45 A4 BOITE DE 20	L 105 MM	Ep 45 MM D 12 MM	50608
CO006461	12-18/65 BOITE DE 10	L 105 MM	Ep 65 MM D 12 MM	50701
CO006466	16-24/25 BT DE 10	L 130 MM	Ep 25 MM D 16 MM	50706
CO006541	16-24/25 A4 BOITE DE 10	L 130 MM	Ep 25 MM D 16 MM	52940
CO006444	8-12/20 BOITE DE 50	L 80 MM	Ep 20 MM D 08 MM	50681
CO006431	8-12/45 A4 BOITE DE 25	L 80 MM	Ep 45 MM D 08 MM	50598
CO006467	16-24/55 BOITE DE 5	L 130 MM	Ep 55 MM D 16 MM	50707

CHEVILLE TRIGA Z QDC



Cheville Haute Performance pour charges très élevées version tête fraisée zinguée

RÉF. ART.	DESCRIPTION	LONGUEUR	DIAMETRE	REFERENCE FABRI- CANT
CO006437	M12	L 105 MM	D 18 MM	50671

CHEVILLE TRIGA Z TF V



Cheville Haute Performance pour charges très élevées version tête fraisée zinguée

RÉF. ART.	DESCRIPTION	LON- GUEUR	EPAIS- SEUR	DIAMETRE	REFERENCE FABRICANT
CO006456	10-15/27 BOITE DE 25	L 80 MM	Ep 10 MM	D 10 MM	50695
CO006474	12-18/40 BOITE DE 10	L 105 MM	Ep 40 MM	D 12 MM	50715
CO006448	8-12/16 BOITE DE 25	L 80 MM	Ep 16 MM	D 08 MM	50686
CO006551	8-12/26 BOITE DE 50	L 80 MM	Ep 26 MM	D 08 MM	53002
CO006925	8-12/30 A4	L 80 MM	Ep 30 MM	D 08 MM	57902 -

photos non contractuelles

CHEVILLE TRIGA Z V



Cheville Haute Performance pour charges très élevées version vis zinguée

RÉF. ART.	DESCRIPTION	LON-GUEUR	DIAMÈTRE	REFERENCE FABRICANT
CO006439	6-10/20 BOITE DE 100	L 70 MM	Ep 20 MM D 06 MM	50674
CO006438	6-10/5 BOITE DE 100	L 70 MM	Ep 05 MM D 06 MM	50673
CO006441	8-12/1 BOITE DE 100	L 80 MM	Ep 01 MM D 08 MM	50677
CO006442	8-12/10 BOITE DE 50	L 80 MM	Ep 10 MM D 08 MM	50678
CO006443	8-12/20 BOITE DE 50	L 80 MM	Ep 20 MM D 08 MM	50679
CO006430	8-12/25 A4 BOITE DE 25	L 80 MM	Ep 30 MM D 08 MM	50596
CO006550	8-12/50 BOITE DE 50	L 80 MM	Ep 50 MM D 08 MM	53001
CO006449	10-15/1 BOITE DE 25	L 90 MM	Ep 01 MM D 10 MM	50687
CO006450	10-15/10 BOITE DE 25	L 90 MM	Ep 10 MM D 10 MM	50688
CO006432	10-15/25 A4 BOITE DE 25	L 90 MM	Ep 25 MM D 10 MM	50601
CO006552	10-15/55 BOITE DE 25	L 90 MM	Ep 55 MM D 12 MM	53003
CO006457	12-18/10 BOITE DE 25	L 80 MM	Ep 30 MM D 12 MM	50696 -
CO006553	12-18/55 BOITE DE 25	L 105 MM	Ep 55 MM D 12 MM	53004
CO006465	16/25 BOITE DE 10	L 130 MM	Ep 25 MM D 16 MM	50705
CO006464	16-24/10 BOITE DE 10	L 130 MM	Ep 10 MM D 16 MM	50704
CO006469	16-24/50 BOITE DE 10	L 130 MM	Ep 50 MM D 16 MM	50710
CO006470	20-28/25 BOITE DE 5	L 160 MM	Ep 25 MM D 20 MM	50711
CO006434	12-18/25 A4 BOITE DE 25	L 105 MM	Ep 25 MM D 12 MM	50605

CHEVILLES PLACO CC



CHEVILLE METAL AVEC VIS POUR CLOISONS CREUSES

RÉF. ART.	DESCRIPTION	LON-GUEUR	DIAMÈTRE	REFERENCE FABRICANT
CO006954	4-24/46 AV BOITE DE 100	L 46 MM	Ep 20 MM D 08 MM	61050

CHEVILLES ZENTECH



CHEVILLE METAL AVEC VIS POUR CLOISONS CREUSES

RÉF. ART.	DESCRIPTION	LON-GUEUR	DIAMÈTRE	REFERENCE FABRICANT
CO006953	4-13/33 AV BOITE DE 100 POUR BA13	L 34 MM	Ep 18 MM D 04 MM	61040
CO006955	5-14/34 AV BOITE DE 100 POUR BA13	L 34 MM	Ep 18 MM D 08 MM	61070
CO006958	6-13/34 AV BOITE DE 100	L 35 MM	Ep 18 MM D 10 MM	61110

DYNABOLT HB



Cheville à expansion pour charges moyennes

RÉF. ART.	DESCRIPTION	LON-GUEUR	DIAMÈTRE	REFERENCE FABRICANT
CO006405	M 10X105/45 EN BOITE DE 20	L 105 MM	Ep 45 MM D 10 MM	50260
CO006403	M 10X65/12 EN BOITE DE 25	L 65 MM	Ep 12 MM D 10 MM	50258
CO006404	M 10X75/18 EN BOITE DE 25	L 75 MM	Ep 18 MM D 10 MM	50259
CO006406	M 12X110/49 EN BOITE DE 10	L 110 MM	Ep 49 MM D 12 MM	50262
CO006398	M 6X45/8 BOITE DE 100	L 45 MM	Ep 08 MM D 06 MM	50252
CO006399	M 6X70/30 BOITE DE 50	L 70 MM	Ep 30 MM D 06 MM	50253
CO006400	M 8X55/10 BOITE DE 50	L 55 MM	Ep 10 MM D 08 MM	50255
CO006401	M 8X80/35 BOITE DE 25	L 80 MM	Ep 35 MM D 08 MM	50256

photos non contractuelles

FIX Z XTREM



RÉF. ART.	DESCRIPTION	LON- GUEUR	EPAIS- SEUR	DIAMETRE	REFERENCE FABRICANT
CO010695	10x100/20	L 100 MM	Ep 20 MM	D 10 MM	57770
CO010692	10x140/60	L 140 MM	Ep 60 MM	D 10 MM	57772
CO010704	10x85/5	L 85 MM	Ep 05 MM	D 10 MM	57768
CO010740	12x105/10	L 105 MM	Ep 10 MM	D 12 MM	57775
CO010691	12x115/20	L 115 MM	Ep 20 MM	D 12 MM	57776
CO010697	12x135/40	L 135 MM	Ep 40 MM	D 12 MM	57777
CO010693	12x180/85	L 180 MM	Ep 85 MM	D 12 MM	57779
CO010690	16X145/25	L 145 MM	Ep 25 MM	D 16 MM	57781
CO010705	16x180/60	L 180 MM	Ep 60 MM	D 16 MM	57783
CO010689	8x120/60	L 120 MM	Ep 60 MM	D 08 MM	57766
CO010706	8x65/5	L 65 MM	Ep 05 MM	D 08 MM	57763
CO010707	8x90/30	L 90 MM	Ep 30 MM	D 08 MM	57765

FIXELEC



EMBASE 0 CHEVILLE POUR COLLIER

RÉF. ART.	DESCRIPTION	LONGUEUR	DIAMETRE	REFERENCE FABRI- CANT
CO007528	8 BOITE DE 100	L 43 MM	D 08 MM	565340

GUARDIA



Cheville universelle pour tout type de gardes corps

RÉF. ART.	DESCRIPTION	LON- GUEUR	EPAIS- SEUR	DIAMETRE	REFERENCE FABRICANT
CO006512	12x105/20 SPIT	L 105 MM	Ep 20 MM	D 12 MM	51061
CO006702	12x110/20 A4	L 110 MM	Ep 20 MM	D 12 MM	55304

ISO

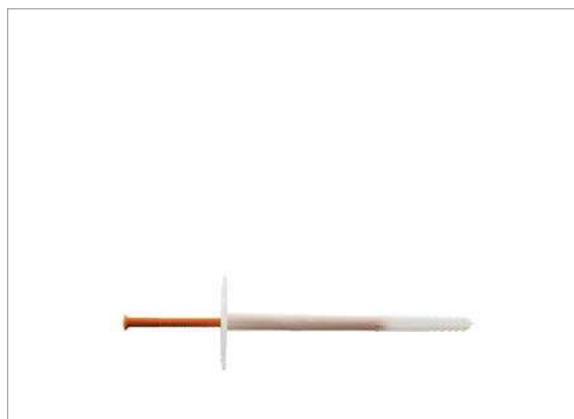

EPAISSEUR ISOLANT MINI/MAXI

RÉF. ART.	DESCRIPTION	LON- GUEUR	DIAMETRE	REFERENCE FABRICANT
CO006913	10-110/120 TETE DE 50 MM EN BOITE DE 200	L 155 MM	Ep 120 MM	D 10 MM 57640
CO006914	10-130/140 TETE DE 50 MM EN BOITE DE 200	L 175 MM	Ep 140 MM	D 10 MM 57650
CO006915	10-150/160 T.50 BOITE DE 200	L 195 MM	Ep 160 MM	D 10 MM 57651
CO010710	10X115/75-85 T60	L 115 MM	Ep 85 MM	D 10 MM 60001
CO010711	10X95/45-65 T60	L 95 MM	Ep 65 MM	D 10 MM 57611

photos non contractuelles

ISOMAX VIS METAL

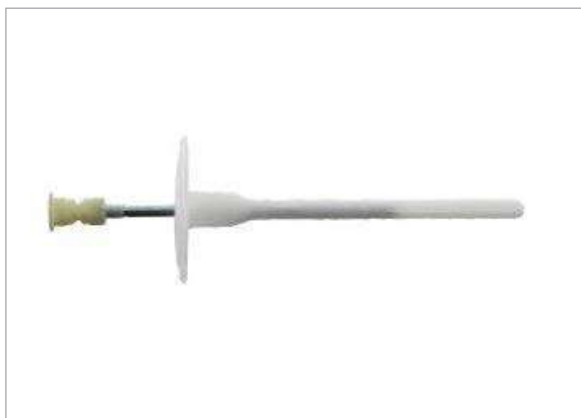
CHEVILLE ISOLATION AVEC CLOU D'EXPANSION

RÉF. ART.	DESCRIPTION	LON- GUEUR	Ep	DIAME- TRE	REFERENCE FABRICANT
CO006216	8X115/80 BOITE DE 200	L 115 MM	Ep 80 MM	D 08 MM	12567
CO006217	8X135/100 BOITE DE 200	L 135 MM	Ep 100 MM	D 08 MM	12568
CO006218	8X155/120 BOITE DE 200	L 155 MM	Ep 120 MM	D 08 MM	12569
CO006219	8X175/140 BOITE DE 100	L 175 MM	Ep 140 MM	D 08 MM	12572
CO006220	8X195/160				54875
CO006221	8X215/180 BOITE DE 100	L 215 MM	Ep 180 MM	D 08 MM	12574
CO006222	8X235/200 BOITE DE 100	L 235 MM	Ep 200 MM	D 08 MM	12575
CO006223	8X275/240 BOITE DE 200	L 275 MM	Ep 240 MM	D 08 MM	12577
CO006224	8X295/260 BOITE DE 100	L 295 MM	Ep 260 MM	D 08 MM	12578
CO006225	8X315/280 BOITE DE 100	L 315 MM	Ep 280 MM	D 08 MM	12579
CO006226	8X335/300				54882
CO006227	8X355/320 BOITE DE 100	L 355 MM	Ep 320 MM	D 08 MM	12581

ISOMAX N CLOU METAL



CHEVILLE ISOLATION AVEC CLOU D'EXPANSION

RÉF. ART.	DESCRIPTION	LON- GUEUR	Ep	DIAME- TRE	REFERENCE FABRICANT
CO006228	N 8X115/80 BOITE DE 200	L 115 MM	Ep 80 MM	D 08 MM	12590
CO006229	N 8X135/100 BOITE DE 200	L 135 MM	Ep 100 MM	D 08 MM	12591
CO006230	N 8X155/120 BOITE DE 200	L 155 MM	Ep 120 MM	D 08 MM	12592
CO006231	N 8X175/140 CLOU METAL				54909
CO006232	N 8X195/160 BOITE DE 100	L 195 MM	Ep 160 MM	D 08 MM	12594
CO006233	N 8X215/180 BOITE DE 100	L 215 MM	Ep 180 MM	D 08 MM	12595
CO006234	N 8X235/200 BOITE DE 100	L 235 MM	Ep 200 MM	D 08 MM	12596
CO017021	N 8X275/240 BOITE DE 100	L 275 MM	Ep 240 MM	D 08 MM	12598

ISOMET



Cheville spéciale isolation résistante au feu

RÉF. ART.	DESCRIPTION	LON- GUEUR	EPAIS- SEUR	DIAMETRE	REFERENCE FABRICANT
CO006701	8X200X250 GALVA	L 250 MM	Ep 200 MM	D 08 MM	55291

photos non contractuelles

ISOWOOD



CHEVILLE POUR ISOLANTS SUR SUPPORT BOIS

RÉF. ART.	DESCRIPTION	LONGUEUR	ÉPAISSEUR	REFERENCE FABRICANT
CO006766	100 BOITE DE 200	L 120 MM	Ep 100 MM	54859
CO006767	120	L 140 MM	Ep 120 MM	54861
CO006762	40	L 60 MM	Ep 40 MM	54856
CO006763	60	L 80 MM	Ep 60 MM	54857
CO006764	80	L 100 MM	Ep 80 MM	54858

LAITON

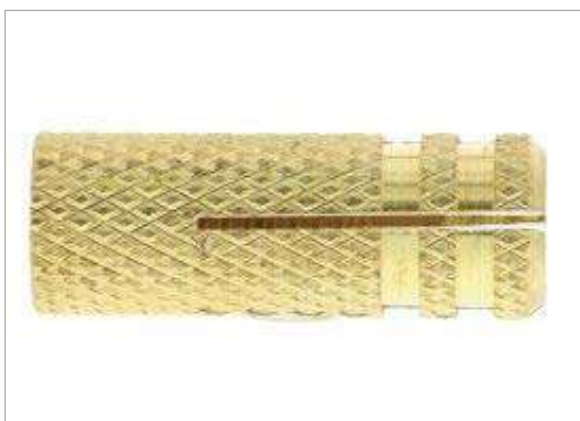

CHEVILLE FEMELLE POUR CHARGE LEGERE

RÉF. ART.	DESCRIPTION	LONGUEUR	DIAMETRE	REFERENCE FABRICANT
CO006984	6X23 BOITE DE 100	L 23 MM	D 06 MM	62450
CO006985	8X28 BOITE DE 100	L 28 MM	D 08 MM	62460

MINI DRIVA ZAMAK



CHEVILLE AUTO-FOREUSE POUR FIXATION GOULOTTES

RÉF. ART.	LONGUEUR	DIAMETRE	REFERENCE FABRICANT
CO006932	L 26 MM	D 08 MM	59430

OUTIL DE POSE POUR CHEVILLE GRIP



CHEVILLE GRIP
Expansion au marteau

RÉF. ART.	DESCRIPTION	LONGUEUR	DIAMETRE	REFERENCE FABRICANT
CO006395	A4 M10X40	L 40 MM	D 10 MM	50216
CO006396	A4 M16X65	L 65 MM	D 16 MM	50218
CO006394	A4 M8X30	L 30 MM	D 08 MM	50215
CO006511	S/L M10X30		D 10 MM	51015
CO006485	S/L M6X25		D 06 MM	50921
CO006486	M 6		D 06 MM	50922
CO006487	M8 COLLERETTE		D 08 MM	50923
CO006488	M10 COLLERETTE		D 10 MM	50924
CO006489	M12 COLLERETTE		D 12 MM	50925
CO006490	M16 COLLERETTE		D 16 MM	50926
CO006393	S M6X30	L 30 MM	D 06 MM	50214

photos non contractuelles

PITON FEMELLE M6



RÉF. ART.	LONGUEUR	DIAMETRE	REFERENCE FABRICANT
EL006366	L 68 MM	D 06 MM	50059

PRIMA M12 D.20 COL SANS VIS



CHEVILLE TOUS MATERIAUX A EXPANSION MAXI

RÉF. ART.	LONGUEUR	DIAMETRE	REFERENCE FABRICANT
CO007022	L 80 MM	D 12 MM	73560

PROLONG



Cheville très grande longueur , pour charges lourdes dans matériaux creux

RÉF. ART.	DESCRIPTION	LON- GUEUR	EPAIS- SEUR	DIAMETRE	REFERENCE FABRICANT
CO006817	10x100 F SPIT	L 100 MM		D 10 MM	566654
CO007545	10x145 F SPIT	L 145 MM	Ep 75 MM	D 10 MM	566656
CO006818	10x160 F SPIT	L 160 MM		D 10 MM	566657
CO006819	10x185 F SPIT	L 185 MM		D 10 MM	566658
CO006820	10x210 F SPIT	L 210 MM		D 10 MM	566659
CO006822	12x120 H SPIT	L 120 MM		D 12 MM	566675
CO007546	12x145 H SPIT	L 145 MM	Ep 75 MM	D 12 MM	566676
CO006823	12x165 H SPIT	L 165 MM		D 12 MM	566677
CO006824	12x185 H SPIT	L 185 MM		D 12 MM	566678
CO006825	12x210 H SPIT	L 210 MM		D 12 MM	566679
CO006826	16x145 H SPIT	L 145 MM		D 16 MM	566680
CO006827	16x165 H SPIT	L 165 MM		D 16 MM	566681
CO006828	16x185 H SPIT	L 185 MM		D 16 MM	566682
CO006829	16x200 H SPIT	L 200 MM		D 16 MM	566683
CO007544	16x240H SPIT	L 240 MM		D 16 MM	566428
CO006830	16x270 H SPIT	L 270 MM		D 16 MM	566684

CHEVILLE PROCTEC



RÉF. ART.	DESCRIPTION
CO005587	BETON
CO005591	PARPAING

APPAREIL A INJECTION CFS

HILTI



MOUSSE HILTI
Pinces

RÉF. ART.	DESCRIPTION	REFERENCE FABRICANT
CO009203	-DISP	2005843

BANDAGE COUPE-FEU

HILTI



RÉF. ART.	DESCRIPTION	REFERENCE FABRICANT
CO011005	CFS-B	429557

BANDE COUPE-FEU

HILTI



Bande coupe-feu

RÉF. ART.	DESCRIPTION	LON- GUEUR	LAR- GEUR	REFERENCE FABRICANT
CO009033	CFS-W EL W45/1.8 P 1000X45X5MM	L 1000 MM	L 45 MM	Ep 5 MM 429556
CO011009	CFS-W SG 110/4 LOT DE 2			429553
CO011011	CFS-W SG 160/6 LOT DE 2			429555

BLOC COUPE-FEU

HILTI



Brique coupe-feu

RÉF. ART.	DESCRIPTION	REFERENCE FABRICANT
CO010601	CFS-BL	2062863

photos non contractuelles

BOUCHON COUPE FEU

HILTI



Bouchon coupe-feu

RÉF. ART.	DESCRIPTION	DIAMETRE	REFERENCE FABRICANT
CO009014	CFS-PL 107	D 107 MM	2059530
CO009930	CFS-PL 132 LOT DE 4	D 132 MM	2059531
CO009931	CFS-PL 158 lot de 2	D 158 MM	2059532
CO009932	CFS-PL 202 LOT DE 2	D 202 MM	2059533

CORDON ROND CPR

HILTI



RÉF. ART.	DESCRIPTION	REFERENCE FABRICANT
CO005017	287-20 ROULEAU DE 20M	211551
CO005019	287-40 ROULEAU DE 20M	211553
CO005020	287-50 ROULEAU DE 20M	211554

COLLIER COUPE FEU

HILTI

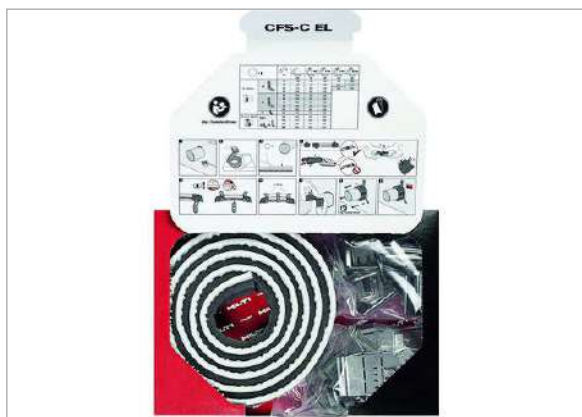

Collier coupe-feu en rouleau

RÉF. ART.	DESCRIPTION	REFERENCE FABRICANT
CO010006	CFS-C EL EN ROULEAU	2075120
CO010354	CFS-C P 160/6	435412
CO009032	CFS-C P 200/8P	435414
CO008537	CFS-C P 250/10	435416
CO011870	COLLIER COUPE-FEU CFS-C P 110/4	435410

DISQUE COUPE-FEU

HILTI



RÉF. ART.	DESCRIPTION	REFERENCE FABRICANT
CO018399	POUR CABLES CFS-D 25 LOT DE 32 -	2116246

photos non contractuelles

ENDUIT COUPE-FEU

HILTI



Prêt à l'emploi, matériau intumescent à base d'eau

RÉF. ART.	DESCRIPTION	REFERENCE FABRICANT
CO005077	CFS-CT 18KG BLANC	2036607
CO005078	CFS-CT 6KG BLANC	2036605

KIT CFS

HILTI



RÉF. ART.	DESCRIPTION	REFERENCE FABRICANT
CO013515	-F FX UNITE	429802

ENDUIT DE CABLES

HILTI



RÉF. ART.	DESCRIPTION	REFERENCE FABRICANT
CO005079	INTUMESCENT CP 678 EN SAC DE 20KG	334892

LUBRIFIANT CFS

HILTI



RÉF. ART.	DESCRIPTION	REFERENCE FABRICANT
CO013969	-T LUB 500 G	2042741

photos non contractuelles

MASTIC CFS



RÉF. ART.	DESCRIPTION	REFERENCE FABRICANT
CO009666	-S SIL CA	2004309

MASTIC COUPE-FEU INTUMESCENT



RÉF. ART.	DESCRIPTION	REFERENCE FABRICANT
CO014028	CFS-IS	2004614

MASTIC COUPE-FEU ACRYLIQUE



RÉF. ART.	DESCRIPTION	REFERENCE FABRICANT
CO009446	CFS-S ACR CG	435862
CO009766	CFS-S ACR CW BLANC	435859

MASTIC COUPE-FEU SILICONE



RÉF. ART.	DESCRIPTION	REFERENCE FABRICANT
CO009198	CFS-S SIL CG	2004358
CO009728	CFS-S SIL CW	2004306

photos non contractuelles

MASTIC DE COLMATAGE COUPE-FEU

HILTI



RÉF. ART.	DESCRIPTION	REFERENCE FABRICANT
CO014030	CFS-FIL	2052899

MORTIER COUPE-FEU

HILTI



 SUR COMMANDE

RÉF. ART.	DESCRIPTION	REFERENCE FABRICANT
CO005236	CFS-M RG 20KG	2018780

PANNEAU COUPE-FEU

HILTI



 SUR COMMANDE

Panneau et enduit coupe-feu pour passages de câbles et de tuyauteries dans des trémies de grandes dimensions

RÉF. ART.	DESCRIPTION	LON- GUEUR	LAR- GEUR	Ep	REFERENCE FABRICANT
CO003359	CFS-CT B 1S CONDITIONNEMENT PAR 5	L 1000 MM	l 600 MM	Ep 50 MM	2036608

SAC COUPE-FEU

HILTI



 SUR COMMANDE

RÉF. ART.	DESCRIPTION	REFERENCE FABRICANT
CO010406	CFS-CU L DIM. 300X170X30MM LOT DE 6	2007447
CO010142	CFS-CU M DIM. 300X80X30MM VENDU A L'UNITE	2007446

photos non contractuelles

SRAY COUPE-FEU

HILTI



RÉF. ART.	DESCRIPTION	REFERENCE FABRICANT
CO009736	JOINT CFS-SP WB BLANC 25KG	430806

TRESS COUPE FEU

HILTI



RÉF. ART.	DESCRIPTION	REFERENCE FABRICANT
CO005018	CFS-CO 30 ROULEAU DE 20M	211552

TABLETTE MASTIC COUPE-FEU

HILTI



RÉF. ART.	DESCRIPTION	REFERENCE FABRICANT
CO014915	CP 617 170X170 LOT DE 20	39214

SUR COMMANDE = soumis à des délais supérieurs à ceux habituels

SUR COMMANDE = SOUMIS À DES DÉLAIS SUPÉRIEURS À CEUX HABITUELS



RÉF. ART.
SUR COMMANDE

ADAPTATEUR DOIGT CF

HILTI



MOUSSE HILTI
Pour mousses CF-F - 12 - 1

RÉF. ART.	DESCRIPTION	REFERENCE FABRICANT
CO000039	-FA1 BOITE DE 12	259766

MOUSSE POLYURETHANE

HILTI



Mousse non Coupe Feu

RÉF. ART.	DESCRIPTION	REFERENCE FABRICANT
CO005240	CF-F CT3 500 ML AVEC BUSE	2053602
CO005244	CF-I CT3 500 ML POUR PISTOLET	3500599
CO005243	CF-I CT3 500ML POUR PISTOLET	2053601
CO005245	CF-I CT3 PLUS PISTOLET CF DS-1	2066011

NETTOYANT CFR1

HILTI



RÉF. ART.	DESCRIPTION	REFERENCE FABRICANT
CO014381	500ML	225386

PISTOLET APPLICATEUR

HILTI



MOUSSE HILTI
Pistolet pour mousse

RÉF. ART.	DESCRIPTION	REFERENCE FABRICANT
CO003561	CF DS-1	259768

photos non contractuelles

ACCOUPEMENT HIT-DL K



RESINE HILTI
Embout pour kit de nettoyage de trous et injection de résine en grande profondeur HIT Rebar - 10 - 10

RÉF. ART.	DESCRIPTION	REFERENCE FABRICANT
CO000021	BOITES ARCHIVES	38250

ADAPTATEUR D'AJUSTAGE TE-C



RÉF. ART.	DESCRIPTION	REFERENCE FABRICANT
CO018755	HVU2 M8-M16	2181356

ADAPTATEUR HAT 28



RÉF. ART.	DESCRIPTION	REFERENCE FABRICANT
CO018756	GUNITE TEST M6 JEU	285562

ADAPTATEUR TIGE FILETÉE M6



RÉF. ART.	REFERENCE FABRICANT
CO018757	285555

APPAREIL A INJECTION S/FIL



RESINE HILTI
Pince d'injection sans fil

RÉF. ART.	DESCRIPTION	REFERENCE FABRICANT
CO020455	APP INJECTION S/FIL HDE500-A22 BOITE	2162794
CO010971	APP. INJECTION S/FIL HDE 500-A22 BOI	3593993

APPAREIL A INJECTION HDE



RESINE HILTI

RÉF. ART.	DESCRIPTION	REFERENCE FABRICANT
CO008431	APPAREIL A INJECTION HDE500-A22 CB/ CR + B22/2.6	3596791

photos non contractuelles

APPAREIL A INJECTION HDM



RESINE HILTI

RÉF. ART.	DESCRIPTION	REFERENCE FABRICANT
CO010973	330 BOI	2005640
CO010974	330 COF	2060429
CO000089	500 CB/CR cof	3549586
CO010975	500 BOI	2005641
CO010976	500 COF	2060870

BUSE MELANGEUR HIT-RE



RESINE HILTI

RÉF. ART.	DESCRIPTION	REFERENCE FABRICANT
CO000402	-M- #	337111

APPAREIL A INJECTION P



RESINE HILTI

Appareil pour injecter la Cheville chimique/résine

RÉF. ART.	DESCRIPTION	REFERENCE FABRICANT
CO000091	8000D	373959

CAPSULE CHIMIQUE HVU2



Capsule souple ultra-performante pour chevillage lourd dans le béton

RÉF. ART.	DESCRIPTION	REFERENCE FABRICANT
CO017877	M10 X90 BOITE DE 20	2164506
CO017993	M10X90 BULK	2164564
CO017878	M12 X110 BOITE DE 20	2164507
CO017994	M12X110 BULK	2164565
CO017879	M16 X125 BOITE DE 20	2164508
CO017995	M16X125 BULK	2164566
CO017880	M20X170 BOITE DE 10	2164509
CO017996	M20X170 BULK	2164567
CO017876	M8X80 BOITE DE 20	2164505
CO017997	M8X80 BULK	2164563

photos non contractuelles

CAPSULE CHIMIQUE HVU TZ



Capsule souple ultra-performante pour chevillage lourd dans le béton

RÉF. ART.	DESCRIPTION	REFERENCE FABRICANT
CO105371	Capsule chimique HVU-TZ M10 lot de 20	2295595

COUPE TIGE FILETEE MRC

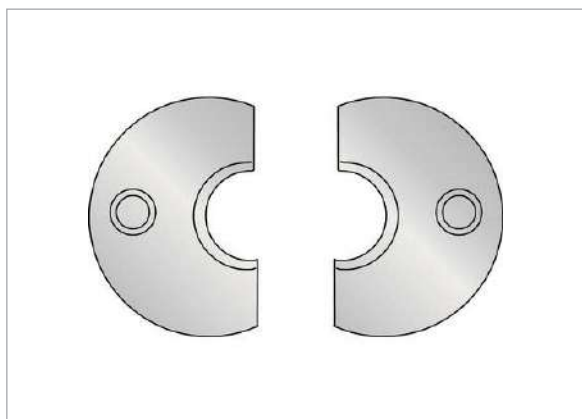

RÉF. ART.	DESCRIPTION	REFERENCE FABRICANT
CO009138	-M8/10	295418

DOUILLE TARAUEE INT. HIS



RESINE HILTI

Douille taraudée standard pour capsules chimiques et scellement par injection (CS)

RÉF. ART.	DESCRIPTION	LON- GUEUR	DIAMETRE	REFERENCE FAB- RICANT
EL010060	HIS-N M12x125 BOITE DE 5	L 125 MM	D 12 MM	258017
EL009252	HIS-N M20X205 BOITE DE 5	L 205 MM	D 20 MM	258019
EL001947	HIT-IC M8X50 BOITE DE 10	L 50 MM	D 08 MM	47938
EL001948	HIT-IC M8X80 BOITE DE 10	L 80 MM	D 08 MM	47935

ECOUVILLON METALLIQUE ROND HIT

HILTI



RESINE HILTI

Pour le nettoyage des trous en profondeur

RÉF. ART.	DESCRIPTION	DIAMETRE	REFERENCE FABRICANT
CO001990	HIT-RB 10	D 10 MM	380917
CO001991	HIT-RB 12	D 12 MM	336548
CO001992	HIT-RB 14	D 14 MM	336549
CO001993	HIT-RB 16	D 16 MM	336550
CO001994	HIT-RB 18	D 18 MM	336551
CO001995	HIT-RB 20	D 10 MM	336552
CO001996	HIT-RB 22	D 12 MM	370774
CO001997	HIT-RB 25	D 15 MM	336553
CO001998	HIT-RB 28	D 18 MM	380919
CO001999	HIT-RB 30	D 10 MM	380920
CO002000	HIT-RB 32	D 12 MM	336554
CO002001	HIT-RB 40	D 10 MM	382260
CO002002	HIT-RB 45	D 15 MM	425408

EMBOU A AIR HIT

HILTI



RESINE HILTI

Pompe soufflante, accessoires de nettoyage pour mortier à injection (buse d'air)

RÉF. ART.	DESCRIPTION	REFERENCE FABRICANT
EL009958	-DL 32	371721

EMBOU POUR INJECTION HIT

HILTI



RESINE HILTI

Accessoires de mortier à injection pour applications d'injection

RÉF. ART.	DESCRIPTION	DIAMETRE	REFERENCE FABRICANT
CO009226	HIT-SZ 14 LOT DE 10	D 14 MM	2039309
CO010518	HIT-SZ 16 LOT DE 10	D 16 MM	2039310
CO010519	HIT-SZ 18 LOT DE 10	D 18 MM	2039311
CO010520	HIT-SZ 20 LOT DE 10	D 20 MM	2039312
CO008938	HIT-SZ 25 LOT DE 10 PCES	D 25 MM	2039315
CO010573	HIT-SZ 28 LOT DE 10 PCES	D 28 MM	2039316
CO008939	HIT-SZ 32 LOT DE 10 PCES	D 32 MM	2039318
CO009600	HIT-SZ 40 LOT DE 10 PCES	D 40 MM	2039325
CO010065	HIT-SZ 42 LOT DE 10 PCES	D 42 MM	2039326
CO010433	HIT-SZ 47 LOT DE 10 PCES	D 47 MM	2039332
CO012824	HIT-SZ 35 LOT DE 10	D 35 MM	2039319
CO012827	HIT-SZ 52 LOT DE 10	D 52 MM	2039333

EXTENSION BROSE HIT

HILTI

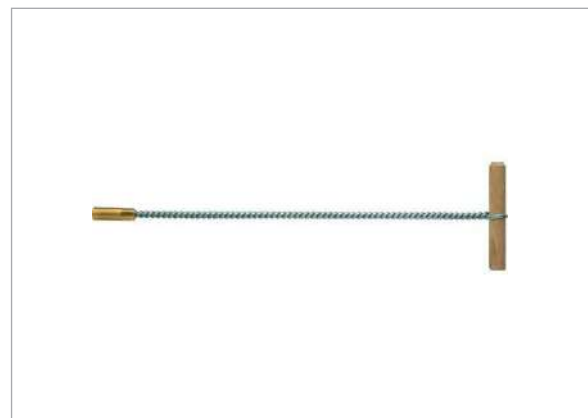

RESINE HILTI

Accessoires pour brossage de mortier à injection

RÉF. ART.	DESCRIPTION	REFERENCE FABRICANT
CO010253	-RBH	229138
CO009176	-RBS-10/0 LONGUEUR 35CM	371722

photos non contractuelles

FLEXIBLE PROLONGATEUR HIT

HILTI



RESINE HILTI

Embout pour kit de nettoyage de trous et injection de résine en grande profondeur HIT Rebar

RÉF. ART.	DESCRIPTION	REFERENCE FABRICANT
CO002307	-DL 10/0.8	38251
CO002308	-DL 16/0.8	38252
CO002309	-VL 16 -	38249
CO008676	FLEXIBLE PROLONGATEUR HI-VL 11/1.0 ROULEAU DE 10M	2042533

KIT 100 BUSES MELANGEUSES HIT

HILTI



RESINE HILTI

Mélangeurs et rallonges pour mortiers à injection

RÉF. ART.	DESCRIPTION	REFERENCE FABRICANT
CO013457	-RE-M	3538657

KIT DE REMPLISSAGE/SISMIQUE

HILTI



RESINE HILTI

Utilisé pour remplir l'espace annulaire des chevilles mécaniques et chimiques (acier au carbone)

RÉF. ART.	DESCRIPTION	DIAMETRE	REFERENCE FABRICANT
CO013540	M8 LOT DE 50	D 08 MM	2127787
CO013535	M8 A4 LOT DE 50	D 08 MM	2127893
CO013536	M10 LOT DE 50	D 10 MM	2127788
CO013532	M12 A4 LOT DE 16	D 12 MM	2127895
CO013537	M12 LOT DE 16	D 12 MM	2127789
CO013538	M16 LOT DE 24	D 16 MM	2127890
CO013539	M24	D 20 MM	2127891

HY 200-R V3

HILTI



RÉF. ART.	DESCRIPTION	REFERENCE FABRICANT
CO105452	HIT- 500ml - vendu à l'unité	3656041

KIT HIT-CT1



Résine Clean Technology pour le béton

RÉF. ART.	DESCRIPTION	REFERENCE FABRICANT
CO013622	KIT HIT CT 1 500 ML vendu à l'unité	3511083

KIT HY 270



RESINE HILTI

RÉF. ART.	DESCRIPTION	REFERENCE FABRICANT
CO020526	KIT 10 CARTOUCHES HIT-HY 270 500ML	3575911

KIT HIT HY 200 A



Résine haute performance pour chevillage lourd et scellement de fers à béton

RÉF. ART.	DESCRIPTION	REFERENCE FABRICANT
CO013624	500 ML vendu à l'unité	3510922

RESINE HIT-HY 270



RÉF. ART.	DESCRIPTION	REFERENCE FABRICANT
CO010251	500 ML POUR MATERIAUX CREUX	2092829

photos non contractuelles

RESINE HIT HY 200



RÉF. ART.	DESCRIPTION	REFERENCE FABRICANT
CO005362	330 ML	2022696

Kit HVU2



RÉF. ART.	DESCRIPTION	REFERENCE FABRICANT
CO105457	M10x90 (20 capsules + 20 tiges) - KIT	3647014

RESINE HIT-CT1



RÉF. ART.	DESCRIPTION	REFERENCE FABRICANT
CO005364	- 330 ML	435992

Kit HVU3



RÉF. ART.	DESCRIPTION	REFERENCE FABRICANT
CO105458	Kit HVU2 M12x110 (20 capsules +20 tiges) - KIT	3647015

photos non contractuelles

Kit HVU4



RÉF. ART.	DESCRIPTION	REFERENCE FABRICANT
CO105459	Kit HVU2 M16x125 (20 capsules +20 tiges) - KIT	3647016

MÉLANGEUR HIT PM



RÉF. ART.	DESCRIPTION	REFERENCE FABRICANT
CO020561	-2173256	2173256

Kit HVU5



RÉF. ART.	DESCRIPTION	REFERENCE FABRICANT
CO105460	Kit HVU2 M8x80 (20 capsules + 20 tiges) - KIT	3647013

MORTIER INJECTION HIT-1



RÉF. ART.	DESCRIPTION	REFERENCE FABRI-CANT
CO017928	MORTIER INJECTION HIT- 1 POUR MATERIAUX CREUX ET PLEIN	2173257

photos non contractuelles

MORTIER INJECTION HIT-HY

HILTI



RÉF. ART.	DESCRIPTION	REFERENCE FABRICANT
CO014366	10 330/2	2090365
CO014367	10 500/2	2090366
CO014374	270 330/2	2092828

PIECE DE RETENUE TE-Y

HILTI



RESINE HILTI
Accessoires pour brossage de mortier à injection

RÉF. ART.	REFERENCE FABRICANT
EL009959	263439

OUTIL DE POSE TE-C

HILTI



RÉF. ART.	DESCRIPTION	DIAMETRE	REFERENCE FABRI-CANT
CO003331	HEX M10		311415
CO003332	HEX M12		311416
EL003335	HSC--MW20	D 20 MM	71353
EL003338	-E M16 5/8 POUR HAS-E M16	D 16 MM	369226
EL003339	-E M8	D 08 MM	369223
EL003340	-HSC-MW14	D 14 MM	31169
EL003341	-HSC-MW16	D 16 MM	11267

PINCE A RESINE HDM

HILTI



RESINE HILTI
Accessoires pour brossage de mortier à injection

RÉF. ART.	DESCRIPTION	REFERENCE FABRICANT
CO003515	330 + HIT-CB 330	2071505
CO003517	500 + HIT-CB 500	2071507
CO003518	500 + HIT-CR 500	2071508

photos non contractuelles

POMPE SOUFFLANTE A DEPOUSSIERER

HILTI



RESINE HILTI
Pompe soufflante à dépeussierer

RÉF. ART.	REFERENCE FABRICANT
CO003686	60579

RACCORD HIT

HILTI



RESINE HILTI
Pompe soufflante, accessoires de nettoyage pour résine de scellement

RÉF. ART.	DESCRIPTION	REFERENCE FABRICANT
EL009601	-DL A FLEXIBLE 36 MM	336643

PORTE CARTOUCHE

HILTI



RESINE HILTI
Porte-cartouche (noir)

RÉF. ART.	DESCRIPTION	REFERENCE FABRICANT
CO010574	HIT-CB 330 NOIR	2007056
CO003695	HIT-CB500 NOIR	2007057
CO010575	HIT-CR 330 ROUGE	2007058
CO008619	HIT-CR500 ROUGE	2007059

TAMIS HIT-S

HILTI



RÉF. ART.	DESCRIPTION	REFERENCE FABRICANT
CO004202	12/I KIT BOITE DE 20	49766
CO004205	16X1M BOITE DE 10	49763

photos non contractuelles

TAMIS HIT-SC

HILTI



RESINE HILTI

Tamis connectible pour installation dans les matériaux creux - Tamis composite et connectable pour injection de scellement chimique

RÉF. ART.	DESCRIPTION	REFERENCE FABRICANT
CO004206	12 X 50 BTE DE 20	375979
CO004207	12 X 85 BTE DE 20	375980
CO004208	16 X 50 BTE DE 20	375981
CO004209	16 X 85 BTE DE 20	375982
CO004210	18X50 BTE DE 20	360485
CO009788	18X85 BTE DE 20	360486
CO014919	22X50 LOT DE 20	273662

TIGE ANCRAGE HAS-U 5.8

HILTI



RÉF. ART.	DESCRIPTION	REFERENCE FABRICANT
CO102322	M8X110 (BOITE DE 20)	2223853
CO102321	M8X80 (BOITE DE 20)	2223852

TIGE D'ANCRAGE HAS-U A4

HILTI



RÉF. ART.	DESCRIPTION	REFERENCE FABRICANT
CO101348	M16x300	2223922

TIGE D'ANCRAGE HAS-E-R

HILTI



RESINE HILTI

Version en acier inoxydable (conformément à DIN 1.4401/316SS) à tête conique. Pour capsules HVU et scellement à injection HIT - Inox - Diamètre X Profondeur d'implantation / Epaisseur à fixer

RÉF. ART.	DESCRIPTION	LON- GUEUR	EPAIS- SEUR	DIAMETRE	REFERENCE FABRICANT
CO004341	M30X270/70 LOT DE 2	L 270 MM	Ep 70 MM	D 30 MM	333139

TIGE D'ANCRAGE HAS-RTZ



RÉF. ART.	DESCRIPTION	REFERENCE FABRICANT
CO004369	M20X170/40 LOT DE 4	335944

TIGE D'ANCRAGE HAS-TZ



RESINE HILTI
Tige d'ancrage dans le béton fissuré avec les capsules HVU-TZ (version galvanisée) - Electrozingué - Diamètre X Profondeur d'implantation / Epaisseur à fixer

RÉF. ART.	DESCRIPTION	LON- GUEUR	EPAIS- SEUR	DIAMETRE	REFERENCE FABRICANT
CO004370	M10X75/15 LOT DE 10	L 75 MM	Ep 15 MM	D 10 MM	310018
CO004371	M10X75/30 LOT DE 10	L 75 MM	Ep 30 MM	D 10 MM	308383
CO004372	M10X75/50 LOT DE 10	L 75 MM	Ep 50 MM	D 10 MM	308384
CO004373	M12x95/100 LOT DE 10	L 95 MM	Ep 100 MM	D 12 MM	308387
CO004374	M12x95/25 LOT DE 10	L 95 MM	Ep 25 MM	D 12 MM	308385
CO004378	M16x105/60 LOT DE 5	L 105 MM	Ep 60 MM	D 16 MM	308389
CO004379	M16X125/100 LOT DE 5	L 125 MM	Ep 100 MM	D 16 MM	332521
CO004380	M16X125/30 LOT DE 60	L 125 MM	Ep 30 MM	D 16 MM	332519
CO004382	M20X170/40 LOT DE 4	L 170 MM	Ep 40 MM	D 20 MM	335943

TIGE D'ANCRAGE HAS-U 5.8



RÉF. ART.	DESCRIPTION	REFERENCE FABRICANT
CO105663	M6x105 - LOT DE 20	2223704
CO940002	M6X75 (LOT DE 20)	2223936
CO105664	M8x150 - LOT DE 20	2223854
CO940011	M10X95 (LOT DE 20)	2223705
CO105647	M10x115 - LOT DE 20	2223706
CO020800	M10x130	2223707
CO020860	M10X190 (LOT DE 20)	2223820
CO105648	M12x110 - LOT DE 20	2223821
CO105649	M12x120 - LOT DE 20	2223822
CO105650	M12x160 - LOT DE 20	2223823
CO105651	M12x160 BULK - LOT DE 100	2223824
CO940024	M12X180	2223825
CO105652	M12x300 - LOT DE 20	2223868
CO100083	M16X190 (LOT DE 20)	2223830
CO100492	M16X300 (LOT DE 10)	2223870
CO105653	M16x150 - LOT DE 20	2223828
CO020874	M16X165 (LOT DE 20)	2223829
CO105654	M16x190 BULK - LOT DE 50	2223831
CO105655	M20x180 - LOT DE 10	2223873
CO105656	M20x240 - LOT DE 10	2223874
CO105657	M20x260 - LOT DE 10	2223876
CO105658	M20x300 - LOT DE 10	2223877
CO105659	M20x350 - LOT DE 10	2223878
CO105660	M20x400 - LOT DE 10	2223879
CO105661	M20x480 - LOT DE 10	2223880
CO020854	M24X300 (LOT DE 5)	2223881
CO105662	M24x450 - LOT DE 5	2223882
CO105621	HDG M10x115 - LOT DE 20	2223860
CO105622	HDG M10x130 - LOT DE 20	2223861
CO105623	HDG M10x170 - LOT DE 20	2223862
CO105624	HDG M10x95 - LOT DE 20	2223859
CO105625	HDG M12x110 - LOT DE 20	2223937
CO105626	HDG M12x120 - LOT DE 20	2223938
CO105627	HDG M12x160 - LOT DE 20	2223939
CO105628	HDG M12x220 - LOT DE 20	2223942
CO105629	HDG M12x260 - LOT DE 20	2223895
CO105630	HDG M16x150 - LOT DE 20	2223943
CO105631	HDG M16x165 - LOT DE 20	2223944
CO105632	HDG M16x190 - LOT DE 20	2223945
CO105633	HDG M16x220 - LOT DE 20	2223946
CO105634	HDG M16x260 - LOT DE 10	2223897
CO105635	HDG M16x300 - LOT DE 10	2223898
CO105636	HDG M16x350 - LOT DE 10	2223899
CO105637	HDG M16x500 - LOT DE 10	2223900
CO105638	HDG M20x180 - LOT DE 10	2223901
CO105639	HDG M20x240 - LOT DE 10	2223902
CO105640	HDG M20x260 - LOT DE 10	2223903

photos non contractuelles

»

RÉFÉRENCE	ARTICLE	DESCRIPTION	
CO105641	HDG M20x300	- LOT DE 10	2223904
CO105642	HDG M20x350	- LOT DE 10	2223905
CO105643	HDG M20x400	- LOT DE 10	2223906
CO105644	HDG M20x480	- LOT DE 10	2223907
CO105645	HDG M24x300	- LOT DE 5	2223908
CO105646	HDG M24x450	- LOT DE 5	2223909

TIGE D'ANCRAGE HAS-U 8.8



RÉF. ART.	DESCRIPTION	REFERENCE FABRICANT
CO940001	HDG M 12X300H	2223910
CO105665	HDG M10x190 - LOT DE 20	2223948
CO105666	HDG M16x300 - LOT DE 10	2223911
CO105667	HDG M16x380 - LOT DE 10	2223912
CO105668	HDG M20x260 - LOT DE 10	2223914
CO105669	HDG M20x400 - LOT DE 10	2223915
CO105670	HDG M24x300 - LOT DE 5	2223916
CO105671	HDG M27x340 - LOT DE 4	2223917
CO105672	HDG M30x380 - LOT DE 4	2223918
CO105673	HDG M8x150 - LOT DE 20	2223947
CO020711	M10X130 (LOT DE 20)	2237083
CO105674	M10x190 - LOT DE 20	2223833
CO100121	M12X220 (LOT DE 20)	2223949
CO105675	M12x220 - LOT DE 20	2223834
CO101615	M12X300 (LOT DE 20)	2223883
CO105676	M16x190 - LOT DE 20	2223835
CO020927	M16X300 (LOT DE 10)	2223884
CO105677	M16x380 - LOT DE 10	2223885
CO105678	M20x180 - LOT DE 10	2223886
CO105679	M20x260 - LOT DE 10	2223887
CO020614	M20X400 (LOT DE 10)	2223888
CO020619	M20X480 (LOT DE 10)	2223931
CO105680	M24x300 - LOT DE 5	2223889
CO020679	M24X450 (LOT DE 5)	2237081
CO105681	M30x380 - LOT DE 4	2223891
CO105682	M33x420 - LOT DE 4	2223892
CO105683	M36x460 - LOT DE 4	2223893
CO105684	M39x510 - LOT DE 4	2223894
CO105685	M8x150 - LOT DE 20	2223855
CO020941	8.8M12X160 (LOT DE 20)	2237085

TIGE D'ANCRAGE HAS-U A4



RÉF. ART.	DESCRIPTION	REFERENCE FABRICANT
CO020892	8.8 M24X300 (LOT DE 5)	2223932
CO100576	M10x115	2223837
CO105686	M10x130 - LOT DE 20	2223838
CO105687	M10x95 - LOT DE 20	2223836
CO100228	M12X110 (LOT DE 20)	2223842
CO105688	M12x120 - LOT DE 20	2223843
CO100174	M12X160 (LOT DE 20)	2223844
CO105689	M12x300 - LOT DE 20	2223920
CO105690	M16x150 - LOT DE 20	2223848
CO105691	M16x190 - LOT DE 20	2223850
CO105692	M16x220 - LOT DE 10	2223851
CO105693	M16x350 - LOT DE 10	2223923
CO105694	M16x380 - LOT DE 10	2223924
CO105695	M20x180 - LOT DE 10	2223925
CO105696	M20x240 - LOT DE 10	2223926
CO105697	M20x260 - LOT DE 10	2223927
CO105698	M20x300 - LOT DE 10	2223928
CO105699	M20x400 - LOT DE 10	2223930
CO105700	M24x450 - LOT DE 5	2223933
CO105701	M27x340 - LOT DE 4	2223934
CO105702	M30x380 - LOT DE 4	2223935
CO105703	M8x110 - LOT DE 20	2223865
CO940009	M8X150	2223866
CO105704	M8x80 - LOT DE 20	2223864

photos non contractuelles

TIGE D'ANCRAGE HIT-V-5.8



RESINE HILTI

Éléments de fixation pour résines, version zinguée

RÉF. ART.	DESCRIPTION	LONGUEUR	DIAMETRE	REFERENCE FABRI-CANT
CO004391	M10X95 LOT DE 10	L 95 MM	D 10 MM	387057
CO004392	M12X110 LOT DE 10	L 110 MM	D 12 MM	387060
CO004393	M12X120 LOT DE 10		D 12 MM	387147
CO004400	M20X380 LOT DE 10	L 380 MM	D 20 MM	387070
CO004401	M20X480 LOT DE 10	L 480 MM	D 20 MM	387071
CO004402	M24X300 LOT DE 5	L 300 MM	D 24 MM	387072
CO004403	M24X450 LOT DE 10	L 450 MM	D 24 MM	387073
CO004406	M8X110 LOT DE 20	L 110 MM	D 08 MM	387055
CO004407	M8X80 LOT DE 20	L 80 MM	D 08 MM	387054

TIGE D'ANCRAGE HIT-V-8.8



RESINE HILTI

Éléments de fixation pour résines, version zinguée

RÉF. ART.	DESCRIPTION	LONGUEUR	DIAMETRE	REFERENCE FABRI-CANT
CO004411	M16X380 LOT DE 5	L 380 MM	D 16 MM	387067
CO018510	M20X180 LOT DE 5		D 20 MM	2147195

TIGE D'ANCRAGE HIT-V-F



RESINE HILTI

Tige inox

RÉF. ART.	DESCRIPTION	LONGUEUR	DIAMETRE	REFERENCE FABRI-CANT
CO004413	M20X260 PAR LOT DE 5	L 260 MM	D 20 MM	409565
CO009038	M12X280 LOT DE 10	L 280 MM	D 12 MM	409559
CO019003	M16X200 - LOT DE 5			2147700

TIGE D'ANCRAGE HIT-V-R



RESINE HILTI

Tige d'ancrage standard pour scellement par injection (A4 SS)

RÉF. ART.	DESCRIPTION	LONGUEUR	DIAMETRE	REFERENCE FABRI-CANT
CO010067	M24X300 LOT DE 5	L 300 MM	D 24 MM	387152
CO004430	M10X95 LOT DE 10	L 95 MM	D 10 MM	387077
CO004432	M8X150 LOT DE 20	L 150 MM	D 08 MM	387076

photos non contractuelles

TIGE D'ANCRAGE HIT-Z



RESINE HILTI

Tige pour fixation résine HY 200

RÉF. ART.	DESCRIPTION	LONGUEUR	DIAMETRE	REFERENCE FAB- RICANT
CO004438	M12x105 BOITE DE 20	L 105 MM	D 12 MM	2018411
CO004439	M12x140 BOITE DE 20	L 140 MM	D 12 MM	2018412
CO004440	M12x155 BOITE DE 20	L 155 MM	D 12 MM	2018413
CO004441	M12x196 BOITE DE 20	L 196 MM	D 12 MM	2018415
CO004442	M16x155 BOITE DE 12	L 155 MM	D 16 MM	2018416
CO004443	M16x175 BOITE DE 12	L 175 MM	D 16 MM	2018417
CO004444	M16x205 BOITE DE 12	L 205 MM	D 26 MM	2018418
CO004445	M16x240 BOITE DE 12	L 240 MM	D 26 MM	2018419
CO004446	M20x215 BOITE DE 6	L 215 MM	D 20 MM	2018420
CO004447	M20x250 BOITE DE 6	L 250 MM	D 20 MM	2018421
CO014966	M20X300 LOT DE 8		D 20 MM	2106097

TIGE D'ANCRAGE HIT-Z-R



RESINE HILTI

Tige d'ancrage haute performance pour scellement par injection (A4 SS)

RÉF. ART.	DESCRIPTION	LONGUEUR	DIAMETRE	REFERENCE FAB- RICANT
CO014976	M16X155 LOT DE 12		D 16 MM	2018434
CO010084	M16X240 BOITE DE 12	L 240 MM	D 16 MM	2018437

TIGE FILETÉE AM

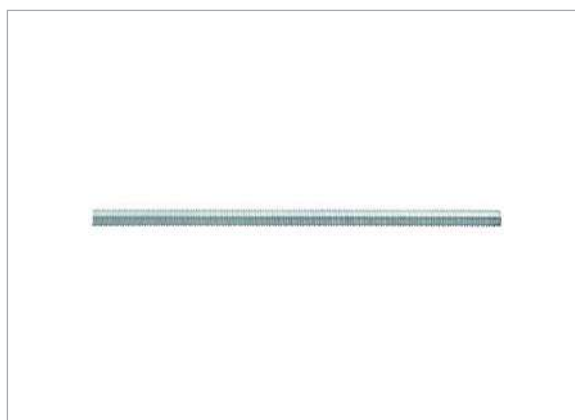

RESINE HILTI

Tige de mesure économique pour scellement par injection (8.8 CS)

RÉF. ART.	DESCRIPTION	LON- GUEUR	DIAMETRE	REFERENCE FAB- RICANT
CO020407	8 X1000 8.8 ZINGUE LOT DE 20		D 08 MM	407496
CO018116	8.8 ZINGUE LOT DE 20	L 1000 MM	D 10 MM	407497

TUBE PROLONGATEUR HIT-VL

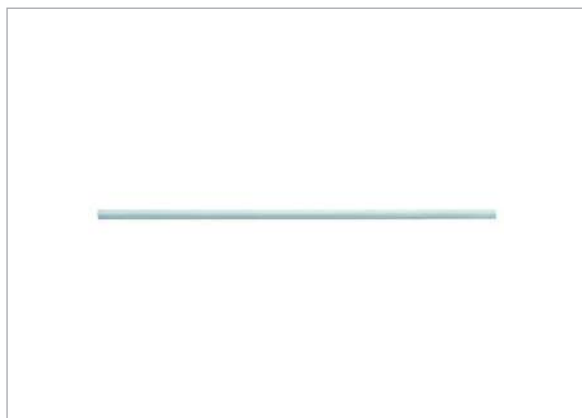

RESINE HILTI

Pompe soufflante, accessoires de nettoyage pour résine de scellement

RÉF. ART.	DESCRIPTION	REFERENCE FABRICANT
CO009602	16/0.7 LOT DE 10	336646

BUSE



RESINE EPOBAR SPIT_RESINE CMIXPLUS SPIT_RESINE EPOMAX SPIT POUR RESINES EPOBAR,EPOMAX

RÉF. ART.	DESCRIPTION	REFERENCE FABRICANT
CO006482	CML 12 SPIT BOITE DE 10 POUR EPOBAR	55823
CO006781	COURTE ID'ALL SPIT BOITE DE 10	50069
CO007499	EPCON & GROS VOLUMES 450-825-530 10P/SAC	55837
CO006784	GROS VOLUME SPIT BOITE DE 10	51510

CAPSULE MAXIMA



CAPSULE PREDOSEE ATE OPTION 7 (PAS DE PERTE)PRODUIT VERT SANS DECHET

RÉF. ART.	DESCRIPTION	DIAMETRE	REFERENCE FABRICANT
CO006516	M8 BOITE DE 10	D 08 MM	60212
CO006517	M10 BOITE DE 10	D 10 MM	51520
CO006518	M12 BOITE DE 10	D 12 MM	51530
CO007511	M16 BOITE DE 10	D 16 MM	51540
CO007512	M20 BOITE DE 10	D 20 MM	51550
CO006519	M24 BOITE DE 10	D 24 MM	51560
CO006520	M30 BOITE DE 5	D 30 MM	51500

COFFRET MAXIMA TIGE+CAPSULE



RÉF. ART.	DESCRIPTION	REFERENCE FABRICANT
CO006367	M8	61750
CO006368	M10	60213
CO006369	M12	60214
CO006370	M16	60211

photos non contractuelles

DOUILLES



RÉF. ART.	DESCRIPTION	LON- GUEUR	DIAMETRE	REFERENCE FAB- RICANT
CO006966	M10X58 SPIT	L 58 MM	D 10 MM	61760
CO006967	M12X75 SPIT jusqu'à épuisement	L 75 MM	D 12 MM	61740
CO006965	M8X70 SPIT	L 70 MM	D 08 MM	52973

ECOUVILLON



LE NETTOYAGE DU TROU EST OBLIGATOIRE POUR AVOIR UN SCELLEMENT DE QUALITE

RÉF. ART.	LONGUEUR	DIAMETRE	REFERENCE FABRICANT
CO006542	L 120 MM	D 11 MM	51010
CO006544	L 120 MM	D 15 MM	52974
CO006545	L 120 MM	D 20 MM	52975
CO006546	L 120 MM	D 22 MM	52976
CO006547	L 120 MM	D 26 MM	52977
CO006548	L 120 MM	D 30 MM	52971

RALLONGE ECOUVILLONS



RESINE EPOBAR SPIT_RESINE EPON SPIT_RESINE EPOMAX
SPIT_RESINE MAXIMA SPIT_RESINE CMIXPLUS SPIT_RESINE
MULTIMAX SPIT
S'ADAPTE SUR POIGNEE EN T (S51009)

RÉF. ART.	DESCRIPTION	REFERENCE FABRICANT
CO006509	SPIT L325	51009

MANCHE POUR ECOUVILLONS



RESINE EPOBAR SPIT_RESINE EPON SPIT_RESINE EPOMAX
SPIT_RESINE MAXIMA SPIT_RESINE CMIXPLUS SPIT_RESINE
MULTIMAX SPIT
POUR ECOUVILLONS 11,15,26,30

RÉF. ART.	DESCRIPTION	REFERENCE FABRICANT
CO006508	SPIT	61660

photos non contractuelles

GOUJONS



RÉF. ART.	DESCRIPTION	REFERENCE FABRICANT
CO006963	M10X100 SPIT	55832

KIT DE NETTOYAGE POSE MANUELLE



RESINE EPOBAR SPIT_RESINE EPCON SPIT_RESINE EPOMAX
 SPIT_RESINE MAXIMA SPIT_RESINE CMIXPLUS SPIT_RESINE
 MULTIMAX SPIT

Composé de : 4 écouvillons, 1poignée en T, 1 rallonge écouvillons,
 1 soufflette

RÉF. ART.	DESCRIPTION	REFERENCE FABRI- CANT
CO006783	KIT DE NETTOYAGE SPIT POSE MANUELLE (380-410 ML)	50067

**OUTIL D INJECTION MANUEL RESINE
EPCON C8**



RESINE EPCON SPIT

RÉF. ART.	DESCRIPTION	REFERENCE FABRICANT
CO007999	450ML	54298

**OUTIL D INJECTION SPIT AUTONOME
PACK EGI**



RESINE EPOBAR SPIT_RESINE CMIXPLUS SPIT_RESINE
 EPOMAX SPIT_RESINE MULTIMAX SPIT
 POUR RESINES EPOBAR,EPOMAX, EPCON C8, DONT ECO-
 TAXE 0,13€

RÉF. ART.	DESCRIPTION	REFERENCE FABRICANT
CO006658	380-410	151500

photos non contractuelles

OUTIL DE POSE TIGES 20-24-30



RESINE MAXIMA SPIT
POUR TIGES SANS TRIANGLE D'ENTRAINEMENT 20,24,30

RÉF. ART.	DESCRIPTION	REFERENCE FABRICANT
CO007185	SPIT	63000

PISTOLET INJECTION MANUELLE RESINE EPOBAR/EPOMAX



RESINE EPOBAR SPIT_RESINE EPOMAX SPIT_RESINE CMIX-PLUS SPIT_RESINE MULTIMAX SPIT

RÉF. ART.	DESCRIPTION	REFERENCE FABRICANT
CO007029	380-4	55838

OUTIL D'INJECTION MANUEL



RESINE CMIXPLUS SPIT_RESINE MULTIMAX SPIT

RÉF. ART.	DESCRIPTION	REFERENCE FABRICANT
CO006993	SPIT (300ml)	55830
CO006782	SPIT (450ml) STANDARD	77151

RALLONGE BUSE GROS VOLUME



RESINE EPOBAR SPIT

RÉF. ART.	DESCRIPTION	LONGUEUR	DIAMETRE	REFERENCE FABRICANT
CO006785	SPIT 18X250 BTE DE 10	L 250 MM	D 18 MM	55887

photos non contractuelles

RESINE EPCON C8

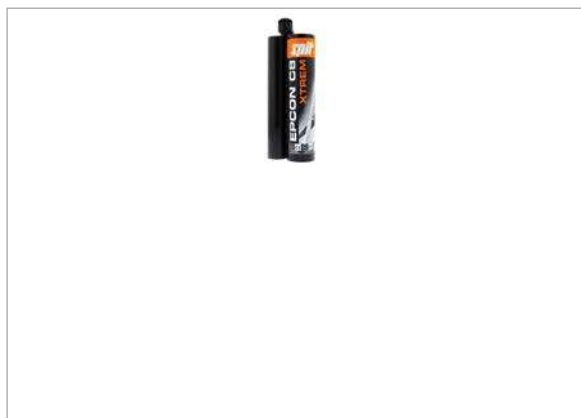

Résine de scellement marque NF, ATE,DTA SISMIQUE catégorie (pure EPOXY pour armature et tiges filetées

RÉF. ART.	DESCRIPTION	REFERENCE FABRICANT
CO006796	CARTOUCHE (450ml)	50998

RESINE VIPER XTREM



Résine de scellement haute performance pour tiges filetées, agréée béton fissuré et non fissuré de M8 à M30 et sismique de M12 à M20, fournie avec 2 buses

RÉF. ART.	DESCRIPTION	REFERENCE FABRICANT
CO018239	CARTOUCHE DE 410 ML	50969

RESINE EPOBAR



Résine ATE -08/0201 pour scellements de fers à béton de 8 mm à 40 mm, livrée avec buse et rallonge - prix de la cartouche

RÉF. ART.	DESCRIPTION	REFERENCE FABRICANT
CO018241	410 ML AVEC BUSE ET RALLONGE	60189

SACHET DE 5 BOUCHONS DE DOSAGE



RESINE EPOBAR SPIT_RESINE EPCON SPIT POUR INJECTION VOLUME NECESSAIRE - 1

RÉF. ART.	REFERENCE FABRICANT
CO006500	65990

photos non contractuelles

SOUFLETTE DE NETTOYAGE SPIT POUR CHEVILLE CHIMIQUE



RESINE EPOBAR SPIT_RESINE EPON SPIT_RESINE EPOMAX
 SPIT_RESINE MAXIMA SPIT_RESINE CMIXPLUS SPIT_RESINE
 MULTIMAX SPIT
 SOUFFLAGE DU TROU (OBLIGATOIRE POUR SCELLEMENT
 RESINES) - 1

RÉF. ART.	REFERENCE FABRICANT
CO007016	55709

TAMIS PLASTIQUE



RÉF. ART.	DESCRIPTION	LONGUEUR	DIAMETRE	REFERENCE FABRI- CANT
CO006759	20X85 (M12)	L 85 MM	D 20 MM	50960

TIGE FILETEE MAXIMA

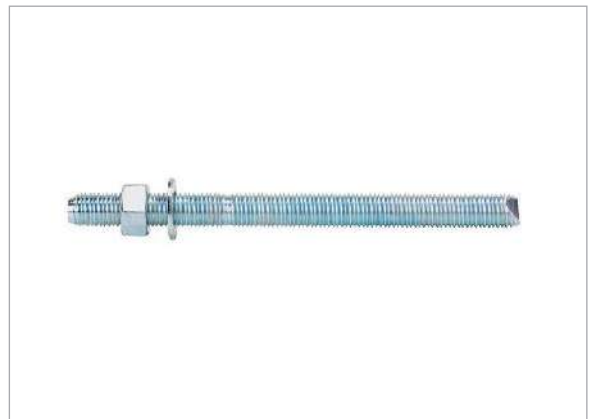

TIGE FILETEE ISOLEE DU MATERIAUX PAS DE RISQUE
 D'OXYDATION

RÉF. ART.	DESCRIPTION	LON- GUEUR	EPAIS- SEUR	DIAMETRE	REFERENCE FABRICANT
CO006499	10X130 BOITE DE 10	L 90 MM	Ep 20 MM	D 10 MM	50970
CO006501	12X160 BOITE DE 10	L 110 MM	Ep 25 MM	D 12 MM	50980
CO006503	16X190 BOITE DE 10	L 190 MM	Ep 35 MM	D 16 MM	655220
CO007728	D20X260 BOITE DE 10			D 20 MM	655240
CO007729	D24X300 BOITE DE 10			D 24 MM	60223

TIGE FILETEE MAXIMA M



TIGE FILETEE ISOLEE DU MATERIAUX PAS DE RISQUE D'OXYDATION

RÉF. ART.	DESCRIPTION	LON- GUEUR	DIAME- TRE	REFERENCE FABRICANT
CO009060	10X130 INOX A4			52440
CO006526	16 INOX A4 EN BTE DE 10	L 190 MM	Ep 35 MM D 16 MM	52450
CO006527	20 INOX A4 EN BTE DE 10	L 260 MM	Ep 65 MM D 20 MM	52470
CO006528	24 INOX A4 EN BTE DE 10	L 300 MM	Ep 63 MM D 24 MM	50940
CO006497	30 BTE DE 5	L 380 MM	Ep 70 MM D 30 MM	50950
CO006498	8 BTE DE 10	L 80 MM	Ep 15 MM D 08 MM	52400
CO006524	8 INOX A4 EN BTE DE 10	L 110 MM	Ep 15 MM D 08 MM	52420
CO008782	12 INOX A4 - BTE DE 10		D 12 MM	55802

TIGES FILETES STANDARD SPIT

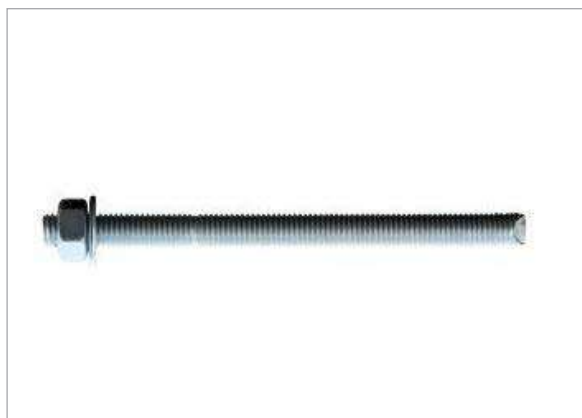

RÉF. ART.	DESCRIPTION	LONGUEUR	DIAMETRE	REFERENCE FABRI- CANT
CO006778	5.8 M12X160	L 160 MM	D 12 MM	55801
CO006777	5.8 M10X130	L 130 MM	D 10 MM	55803
CO006779	5.8 M16X190	L 190 MM	D 16 MM	55800
CO006776	5.8 MBX110	L 110 MM	D 08 MM	63300

TUBE RALLONGE



RESINE EPOBAR SPIT_RESINE EPCON SPIT
COUPER A LA PROFONDEUR DU TROU , DIAM . DE 10 A 12MM

RÉF. ART.	DESCRIPTION	LON- GUEUR	DIAMETRE	REFERENCE FABRICANT
CO006995	1 M POUR BUSE 9X1000 SPIT EN BOITE DE 10	L 1000 MM	D 09 MM	50971

TUBE RALLONGE SOUPLE



RESINE EPOBAR SPIT_RESINE EPCON SPIT
COUPER A LA PROFONDEUR DU TROU SUP. A 13MM - 10

RÉF. ART.	DESCRIPTION	LONGUEUR	DIAMETRE	REFERENCE FAB- RICANT
CO006502	13 X 1000 EN BTE DE 10			55839
CO006786	15X1000 BTE DE 10	L 1000 MM	D 18 MM	

photos non contractuelles

MANCHON ENTRETOISE

HILTI

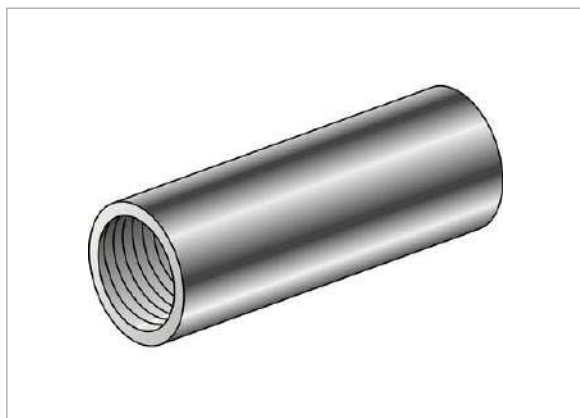

Manchon hexagonal M12x40, visserie standard

RÉF. ART.	DESCRIPTION	LON- GUEUR	DIAMETRE	REFERENCE FABRICANT
CO002795	M8X25-F BOITE DE 50	L 25 MM	D 08 MM	304791
CO008779	M8X30 BOITE DE 50	L 30 MM	D 08 MM	216435
CO009237	M10X30 A4-70 ROND BOITE DE 100	L 30 MM	D 10 MM	266884
CO009158	M10X30 BOITE DE 50	L 30 MM	D 10 MM	216704
CO008780	M10X30 BOITE DE 50	L 30 MM	D 10 MM	216437
CO002794	M10X30-F BOITE DE 50	L 30 MM	D 10 MM	304792
CO002787	M12X40 BOITE DE 50	L 40 MM	D 12 MM	216705
CO018965	M16X50-F LOT DE 20			304794
CO008781	HEX M16X40 BOITE DE 25	L 40 MM	D 16 MM	216706
CO002793	HEX M8X25 BOITE DE 100	L 25 MM	D 08 MM	216703

RONDELLE PLATE

HILTI



RÉF. ART.	DESCRIPTION	DIAMETRE	REFERENCE FABRI- CANT
CO020573	10,5X20X2 ISO 7089 A2		2184481
CO018657	10.5 X20X2 BOITE DE 150		2184511
CO018650	10.5x28x2 A2k VENDU AU 100		2184522
CO018670	16 17X30X3 BOITE DE 50		2184513
CO020574	16 17X30X3 ISO 7089 A2 20		2184550
CO018646	20 21X37X3 ZN ISO 7089		2184512
CO018550	20 21X37X3 ZN ISO 7089 200 BT DE 50		2184514
CO018551	24 25X44X4 ZN ISO 7089 200 BT DE 50		2184515
CO020575	8 8,4X16X1,6 ISO 7089 A2 BOITE DE 200		2184480
CO020576	8,4X40X3 SIM. ISO 7089 A4		2184545
CO003971	A 10.5/20 A4 BOITE DE 150	D 10,5 MM	2184477
CO003972	A 10.5/20-F BTE DE 150	D 10,5 MM	2184530
CO009236	A 10.5/40 A4 INOX BTE DE 50	D 10,5 MM	2184303
CO009385	A 10.5/40 VENDU AU 100	D 10,5 MM	2184517
CO003976	A 13/40 LOT DE 100	D 13 MM	2184518
CO003978	A 17/30 A4 BOITE DE 50	D 17 MM	2184535
CO003979	A 17/40 VENDU AU 100 -2184519	D 17 MM	2184519
CO018413	A 17/40/3 A42 SIM ISO 7089 BT DE 150		2184547
CO020577	A 6,4/12 A2 BOITE DE 50	D 06,4 MM	58915
CO003981	A 6,4/12 ZINGUEE BTE DE 500	D 06,4 MM	2184555
CO009240	A 6,4/12 A2 INOX BOITE DE 150	D 06,4 MM	2184479
CO003982	A 6,4/28 ZINGUEE BTE DE 200	D 06,4 MM	2184520
CO003984	A 8,4/16-F BTE BOITE DE 200	D 08,4 MM	2184529
CO003985	A 8,4/28 LOT DE 100	D 08,4 MM	2184521
CO003986	A 8,4/40 ZINGUEE BTE DE 50	D 08,4 MM	2184516

photos non contractuelles

SPRAY

HILTI



Spray zinc

RÉF. ART.	DESCRIPTION	REFERENCE FABRICANT
CO009244	ZINC MZN-400 EN BOMBE DE 400ML	2048192

TIGE FILETEE AM8X1000

HILTI

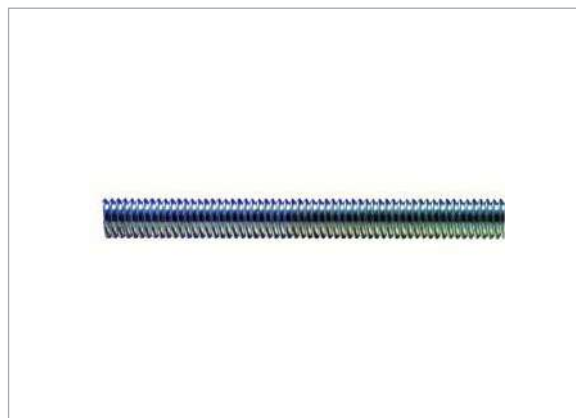

RESINE HILTI

RÉF. ART.	DESCRIPTION	LONGUEUR	DIAMETRE	REFERENCE FABRI-CANT
CO014995	A2-70 LOT DE 10		D 08 MM	58943
CO010145	A4-70 LOT DE 20	L 1000 MM	D 08 MM	58666

TIGE FILETEE AM6X1000

HILTI



RESINE HILTI

RÉF. ART.	DESCRIPTION	LONGUEUR	DIAMETRE	REFERENCE FABRI-CANT
CO009386	4.8 LOT DE 20	L 1000 MM	D 06 MM	339792

TIGE FILETEE AM10X1000

HILTI

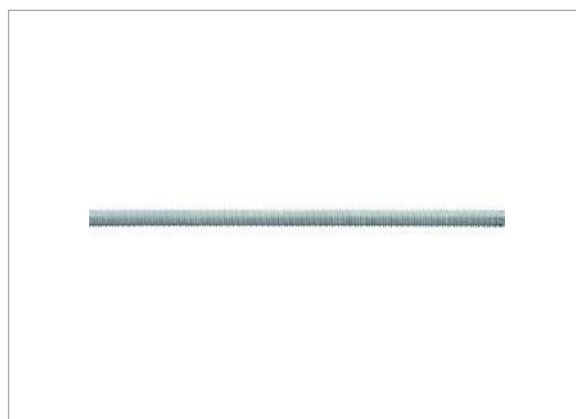

RESINE HILTI

RÉF. ART.	DESCRIPTION	LONGUEUR	DIAMETRE	REFERENCE FABRI-CANT
CO020585	8.8 HDG		D 10 MM	419102
CO014986	A2-70 LOT DE 10		D 10 MM	58944
CO004453	A4-70 LOT DE 10	L 1000 MM	D 10 MM	58670
CO004454	F 4.8 LOT DE 20	L 1000 MM	D 10 MM	304773

photos non contractuelles

TIGE FILETÉE AM12X1000

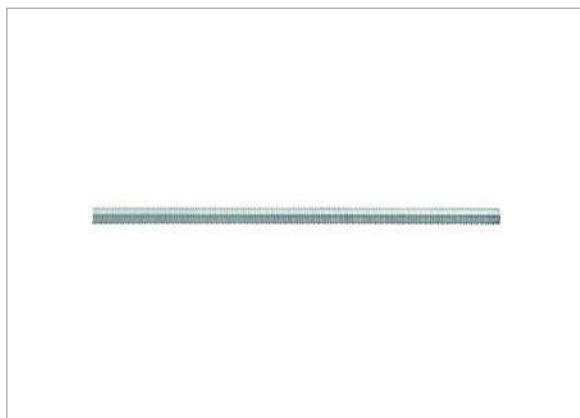
HILTI

RESINE HILTI

RÉF. ART.	DESCRIPTION	LONGUEUR	DIAMETRE	REFERENCE FABRI-CANT
CO020586	8.8 ZINGUÉ		D 12 MM	407498
CO020363	8.8 HDG LOT DE 15		D 12 MM	419103
CO009246	A2-70 INOX LOT DE 5	L 1000 MM	D 12 MM	58945
CO014987	A4-70 LOT DE 5		D 12 MM	58671
CO004455	F 4.8 LOT DE 15	L 1000 MM	D 12 MM	304774

TIGE FILETEE AM16X1000

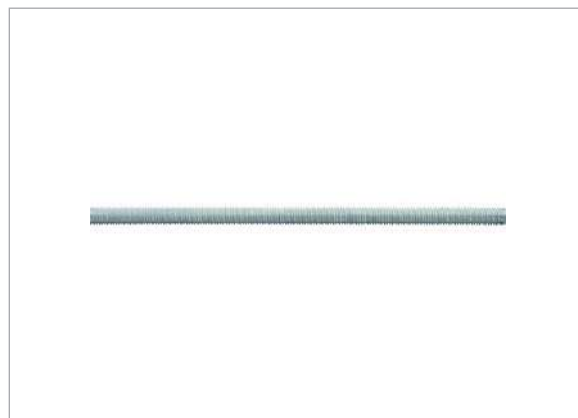
HILTI

RESINE HILTI

RÉF. ART.	DESCRIPTION	LONGUEUR	DIAMETRE	REFERENCE FABRI-CANT
CO019005	8.8 HDG LOT DE 5			419104
CO004457	A2-70 LOT DE 5	L 1000 MM	D 16 MM	58946
CO004458	A4-70 LOT DE 5	L 1000 MM	D 16 MM	58683
CO004459	F 4.8 LOT DE 5	L 1000 MM	D 16 MM	304776

TIGE FILETÉE AM12X2000

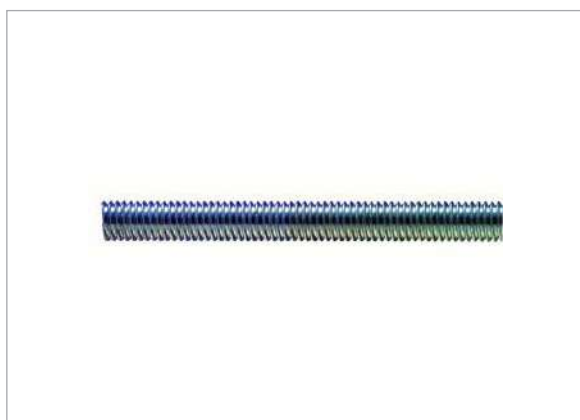
HILTI

RESINE HILTI

RÉF. ART.	DESCRIPTION	LONGUEUR	DIAMETRE	REFERENCE FABRI-CANT
CO004456	4.8 ZINGUEE LOT DE 15	L 2000 MM	D 12 MM	216420

TIGE FILETEE AM16X80

HILTI

RÉF. ART.	DESCRIPTION	LONGUEUR	DIAMETRE	REFERENCE FABRI-CANT
CO004460	4.6 ZINGUEE	L 80 MM	D 16 MM	216403

TIGE FILETEE AM20X1000

HILTI

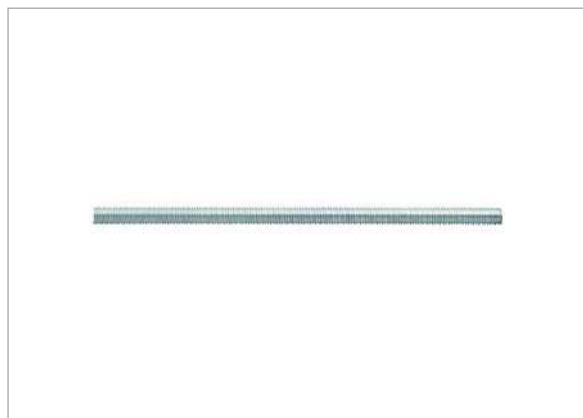

RESINE HILTI

RÉF. ART.	DESCRIPTION	DIAMETRE	REFERENCE FABRICANT
CO020587	8.8 ZINGUÉ	D 20 MM	407500

TIGE FILETÉE AM30X1000

HILTI

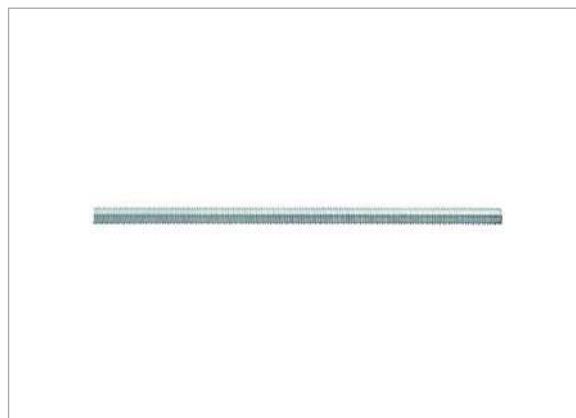

RESINE HILTI

RÉF. ART.	DESCRIPTION	DIAMETRE	REFERENCE FABRICANT
CO018364	8-Aug	D 30 MM	2008139
CO020590	8.8 HDG	D 30 MM	2008339

TIGE FILETÉE AM27X1000

HILTI

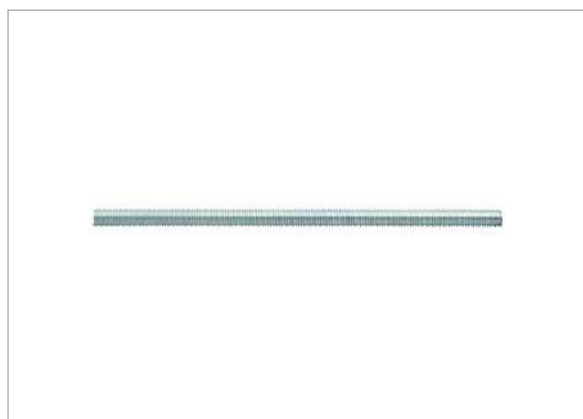

RESINE HILTI

RÉF. ART.	DESCRIPTION	DIAMETRE	REFERENCE FABRICANT
CO020589	8.8 ZINGUÉ	D 27 MM	2008138
CO020588	8.8 HDG	D 27 MM	2008338

TIGE FILETÉE AM33X1000

HILTI

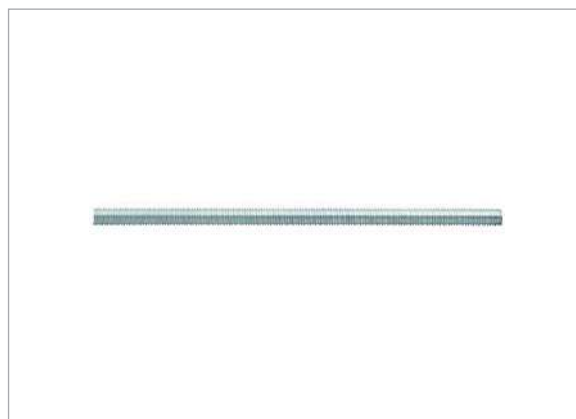

RESINE HILTI

RÉF. ART.	DESCRIPTION	DIAMETRE	REFERENCE FABRICANT
CO020592	8.8 ZINGUÉ	D 33 MM	2008330
CO020591	8.8 HDG -2008340	D 33 MM	2008340

photos non contractuelles

TIGE FILETÉE AM36X1000

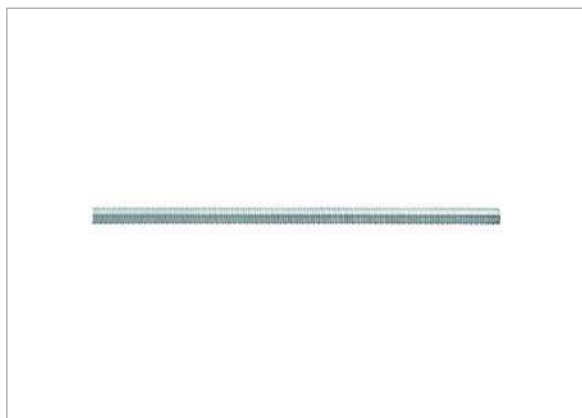
HILTI

RESINE HILTI

RÉF. ART.	DESCRIPTION	DIAMETRE	REFERENCE FABRICANT
CO020594	8.8 ZINGUÉ	D 36 MM	2008331
CO020593	8.8 HDG	D 36 MM	2008341

TIGE FILETÉE AM39X1000

HILTI

RESINE HILTI

RÉF. ART.	DESCRIPTION	DIAMETRE	REFERENCE FABRICANT
CO020595	8.8 ZINGUÉ	D 39 MM	2008332

TIGE FILETEE M10X1000

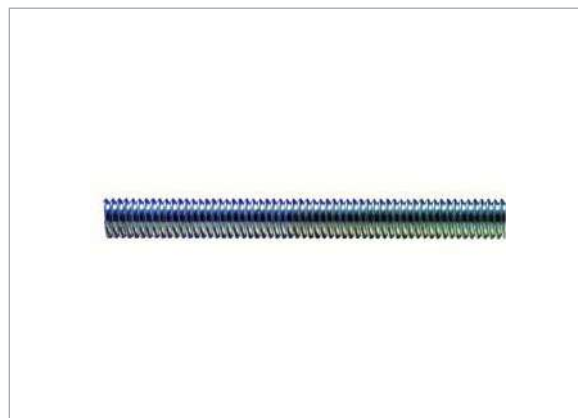
HILTI

RESINE HILTI

Tiges au mètre - Diamète X Longueur en mm

RÉF. ART.	DESCRIPTION	LONGUEUR	DIAMETRE	REFERENCE FABRICANT
CO004463	4.8 ZINGUEE LOT	L 1000 MM	D 10 MM	339795
CO004464	DE 20	L 2000 MM	D 10 MM	339796

TIGE FILETEE M12X1000

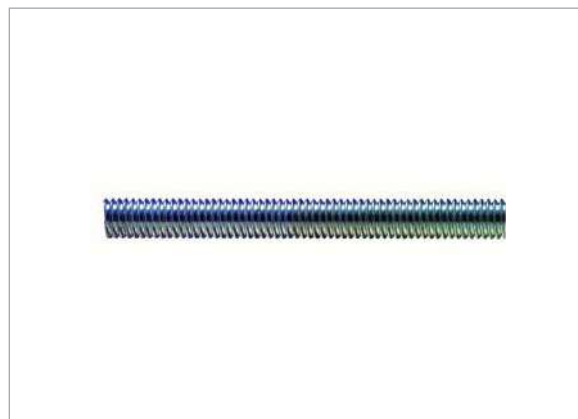
HILTI

RESINE HILTI

Tiges au mètre - Diamète X Longueur en mm

RÉF. ART.	DESCRIPTION	LONGUEUR	DIAMETRE	REFERENCE FABRICANT
CO004466	4.8 ZINGUEE LOT	L 1000 MM	D 12 MM	339797
	DE 15			

TIGE FILETEE M16X1000

HILTI

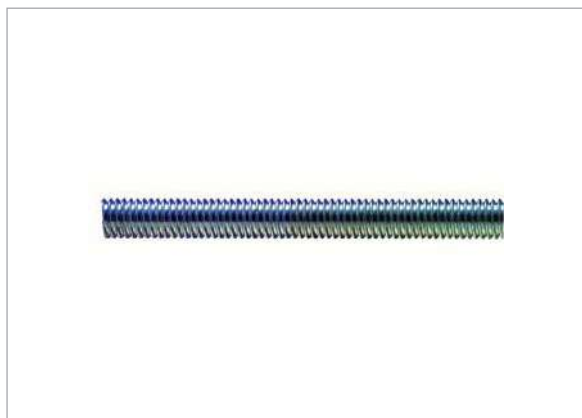

RESINE HILTI

Tiges au mètre - Diamète X Longueur en mm

RÉF. ART.	DESCRIPTION	LONGUEUR	DIAMETRE	REFERENCE FABRICANT
CO004467	4.8 ZINGUEE LOT DE 5	L 1000 MM	D 16 MM	216422

TIGE FILETEE M8X2000

HILTI



RESINE HILTI

Tiges au mètre - Diamète X Longueur en mm

RÉF. ART.	DESCRIPTION	LONGUEUR	DIAMETRE	REFERENCE FABRICANT
CO004470	4.8 ZINGUEE LOT DE 20	L 2000 MM	D 08 MM	339794

TIGE FILETEE M8X1000

HILTI



RESINE HILTI

Tiges au mètre - Diamète X Longueur en mm

RÉF. ART.	DESCRIPTION	LONGUEUR	DIAMETRE	REFERENCE FABRICANT
CO004469	4.8 ZINGUEE LOT DE 10	L 1000 MM	D 08 MM	339793

TUBE FILETE GR

HILTI



Tube fileté pour point fixe Gr-G 5/4", longueur 2mètres - 1

RÉF. ART.	DESCRIPTION	REFERENCE FABRICANT
CO004544	-G 1 1 / 4 2000 4.6 Zn - LOT DE 3	248532

photos non contractuelles

VIS D'AJUSTAGE MFT-JS

HILTI

RÉF. ART.	DESCRIPTION	REFERENCE FABRICANT
CO019007	6X15 A4 LOT DE 100	2156413
CO019008	6X40 LOT DE 100	2030631

VIS HEXAGONALE M6

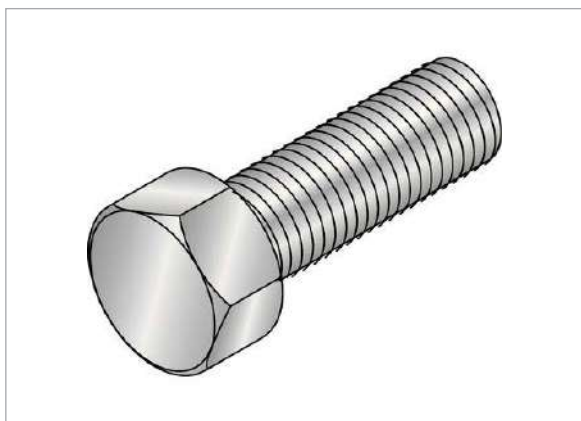
HILTI

RÉF. ART.	DESCRIPTION	LONGUEUR	DIAMETRE	REFERENCE FABRICANT
CO020598	M6X16 ZN DIN 933 8.8	L 16 MM	D 06 MM	2184487

VIS HEXAGONALE M8

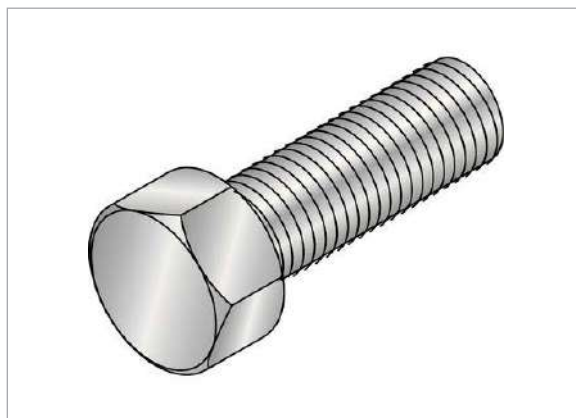
HILTI

RÉF. ART.	DESCRIPTION	LON-GUEUR	DIAMETRE	REFERENCE FABRICANT
CO008791	M8X16 ZINGUEE INOX BOITE DE 50	L 16 MM	D 08 MM	2184490
CO004716	M8 x 25 - F BOITE DE 50	L 25-MM	D 08 MM	2184557
CO009389	M8X20 BOITE DE 50	L 20 MM	D 08 MM	2184491
CO015198	M8X35 A2-70 LOT DE 50		D 08 MM	83241
CO008792	M8X55 ZINGUEE DE 200	L 55 MM	D 08 MM	2184494
CO018674	M8X25 ZN DIN LOT DE 100		D 08 MM	2184492

VIS HEXAGONALE M10

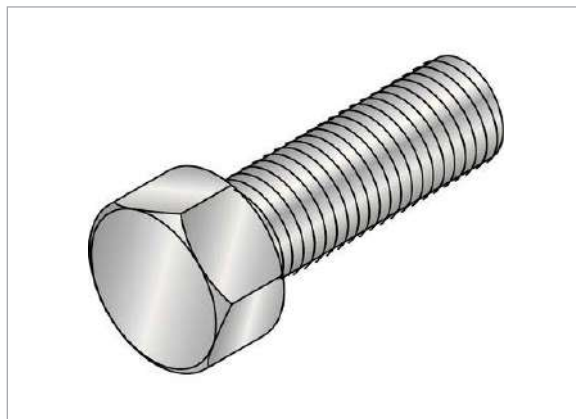
HILTI

RÉF. ART.	DESCRIPTION	LON-GUEUR	DIAMETRE	REFERENCE FABRICANT
CO004711	M10 X 25-F BOITE DE 50	L 25-MM	D 10 MM	2184533
CO009120	M10X20 A4-70 BOITE DE 50	L 20 MM	D 10 MM	26839
CO008794	M10X20 ZINGUEE ZINGUE LOT DE 50	L 20 MM	D 10 MM	2184552
CO009119	M10X25 A2-70 BOITE DE 50	L 25 MM	D 10 MM	83251
CO008796	M10X25 ZINGUEE BOITE DE 100	L 25 MM	D 10 MM	2184495
CO008808	M10X55 ZINGUEE BOITE DE 100	L 55 MM	D 10 MM	2184497

photos non contractuelles

VIS HEXAGONALE M12

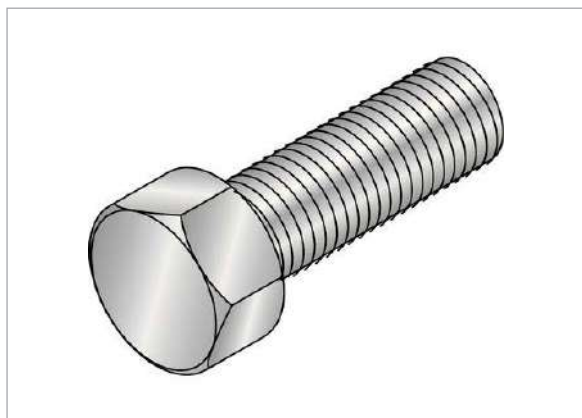

RÉF. ART.	DESCRIPTION	LON-GUEUR	DIAMETRE	REFERENCE FAB-RICANT
CO004713	M12 x 25-F BOITE DE 50	L 25-MM	D 12 MM	2184534
CO008807	M12C35 ZINGUEE BOITE DE 100	L 35 MM	D 12 MM	2184499
CO020597	M12X50 ZN DIN 933 8.8 BT DE 50		D 12 MM	2184483

VIS HEXAGONALE TH MALE

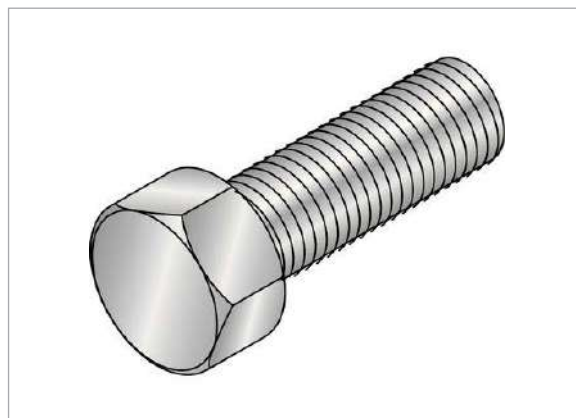

Vis Tête H Mâlezinguée, visserie standard

RÉF. ART.	DESCRIPTION	LON-GUEUR	DIAMETRE	REFERENCE FAB-RICANT
CO004720	M12X25 ZINGUE 2 BTS DE 50	L 25 MM	D 12 MM	2184553
CO004723	M8X35 ZINGUEE BOITE DE 100	L 35 MM	D 08 MM	2184493

VIS HEXAGONALE M16

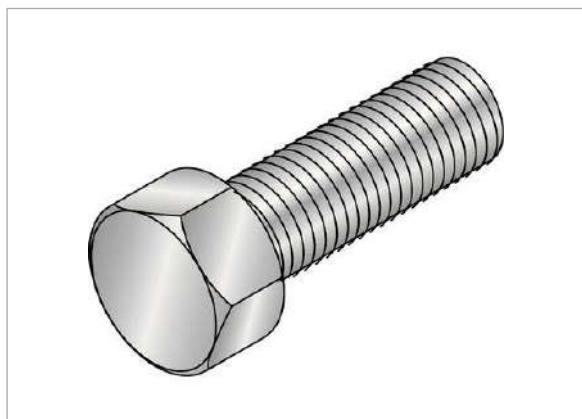

RÉF. ART.	DESCRIPTION	LON-GUEUR	DIAMETRE	REFERENCE FAB-RICANT
CO004714	M16X40 ZINGUEE BOITE DE 50	L 40 MM	D 16 MM	2184307

VIS SIMPLE MIA



Vis simple MIA-EH90, application industrielle

RÉF. ART.	DESCRIPTION	REFERENCE FABRICANT
CO004772	-EH90 BOITE DE 10	304887

photos non contractuelles

PIERRE EN CARBONNE



RÉF. ART.	DESCRIPTION
CO003503	D.16MM
CO003504	D.24MM
CO003505	D.36MM
CO003506	D.60MM

SIGNIFICATION DISTRIPLUS & WE LOVE LIFE



RÉF. ART.
PICTOS

SUR COMMANDE = soumis à des délais supérieurs à ceux habituels

SUR COMMANDE = SOUMIS À DES DÉLAIS SUPÉRIEURS À CEUX HABITUELS



RÉF. ART.
SUR COMMANDE

photos non contractuelles

RUBAN ADHÉSIF DE MASQUAGE



RÉF. ART.
CO000202

RUBAN ADHÉSIF D'EMBALLAGE



RÉF. ART.	DESCRIPTION	LONGUEUR	LARGEUR
CO004015	HAVANE	L 100 M	I 50 MM

DÉVIDOIR POUR RUBAN ADHÉSIF D'EMBALLAGE



RÉF. ART.
EN007228

RUBAN ADHÉSIF EN ALUMINUM



RÉF. ART.	LARGEUR
CO005681	I 50 MM

RUBAN ADHÉSIF DE MASQUAGE



RÉF. ART.	LONGUEUR	LARGEUR
CO003408	L 10 M	I 25 MM
CO003409	L 10 M	I 50 MM

RUBAN ADHÉSIF ORANGE

ROULEAU LONGEUR 33M



RÉF. ART.	LARGEUR
CO004017	I 50 MM
CO004018	I 75 MM

photos non contractuelles

RUBAN ADHÉSIF TOILE AMÉRICAINNE



Rouleau longueur 33m

RÉF. ART.	DESCRIPTION	LARGEUR
CO008387	RUBAN ADHÉSIF	150 MM

SCOTCH DOUBLE-FACE



RÉF. ART.	DESCRIPTION
CO004076	L.25M L.50MM

photos non contractuelles

AÉROSOL GRAISSE MULTI-USAGES



RÉF. ART.
CO004814

BOMBE DE DÉGRIPPANT LUPROTEC



RÉF. ART.
CO004885

AÉROSOL 3/1



RÉF. ART.	DESCRIPTION
EN004811	DÉGRIPPANT/NETTOYANT/LUBRIFIANT

GACHETTE POUR AÉROSOL



RÉF. ART.
OU002329

photos non contractuelles

BOMBE GALVA FROID

technitop
AUTOMATISME - REFRIGERATION



RÉF. ART.

CO004887

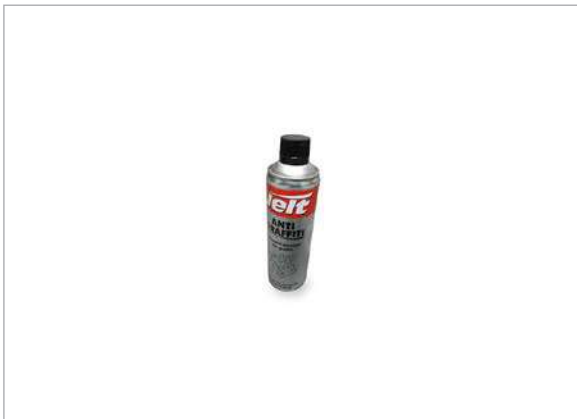
BOMBE GRAFISOLV

RÉF. ART.

CO004888

DÉGRAISSANT SYDOL POUR BANCHES

SID



POUR DEGRAISSER LES BANCHES APRES P2RIODE DE STOCK-
AGE

RÉF. ART.

CO005028

DESCRIPTION

, BIDON DE 25L

GRAISSE FEP2

FUCHS



RÉF. ART.

CO005139

CO005138

DESCRIPTION

EN CARTOUCHE DE 400GR

EN POT DE 5KG

GRAISSE LIEBHERR CTK

LIEBHERR



RÉF. ART.	DESCRIPTION
CO017231	CARTOUCHE 400 GR

HUILE DE CHAINE 5L POUR TRONCONNEUSE

MAKITA



RÉF. ART.	DESCRIPTION
CO005148	

GRAISSE NOIRE TEXBLAK



RÉF. ART.	DESCRIPTION
CO005141	500ML

HUILE GX 80W/90



RÉF. ART.	DESCRIPTION
CO005151	BIDON 1L

GRAISSE RENOLIT LXC2



RÉF. ART.	DESCRIPTION
CO005143	EN CARTOUCHE DE 400GR

photos non contractuelles

PRODUIT MELANGE 2 TEMPS

ASPEN



MELANGE 2 TEMPS - VENDU IDF UNIQUEMENT -

RÉF. ART.	DESCRIPTION
CO005347	ASPEN 2, BIDON DE 5L

HUILE DE MELANGE 2T 5L POUR TRONCONNEUSE

MAKITA



RÉF. ART.
CO005150

PRODUIT MELANGE 4 TEMPS

ASPEN



MELANGE 4 TEMPS - VENDU IDF UNIQUEMENT -

RÉF. ART.	DESCRIPTION
CO005349	PRODUIT 4 TEMPS ASPEN 4, BIDON DE 5L

HUILE MOTEUR 4T 5W30 - 1L

MAKITA

RÉF. ART.
CO010041

CRAIE DE BRIANÇON



RÉF. ART.	DESCRIPTION	COULEUR
CO001752	50 PIECES	BLANC

CRAYON À ENCRE ANILINE



RÉF. ART.
CO001759

CRAIE INDUSTRIELLE



RÉF. ART.	DESCRIPTION	COULEUR
CO001755		BLANC
CO001756		BLEU
CO001757	- BOITE DE 12	JAUNE
CO001758		VERT

CRAYON DE CHARPENTIER



RÉF. ART.	DESCRIPTION
CO001760	L. 30CM, ROUGE

photos non contractuelles

CRAYON DE MAÇON



RÉF. ART.	DESCRIPTION
CO001761	L.30CM, VERT

STYLO FIXOLID



RÉF. ART.	COULEUR
CO008173BC	BLANC
CO008173BL	BLEU
CO008173JA	JAUNE
CO008173RO	ROUGE
CO008173VE	VERT

MARQUEUR INDÉLÉBILE



RÉF. ART.	COULEUR
CO002839	BLEU
CO002840	NOIR
CO002841	ROUGE
CO002842	VERT

TAILLE-CRAYON DE MAÇON ET CHARPENTIER



RÉF. ART.
CO008041

photos non contractuelles

BOMBE DE MARQUAGE BLANC



RÉF. ART.	COULEUR
CO005549BC	BLANC

BOMBE DE MARQUAGE PRO MARKER



RÉF. ART.	DESCRIPTION
CO008170BC	SOPPEC 500ML Blanc

BOMBE DE MARQUAGE FLUO



RÉF. ART.	DESCRIPTION	COULEUR
CO005549BL	BOMBE DE MARQUAGE - 500ML	BLEU
CO005549JA		JAUNE
CO005549MA		MARRON
CO005549OR		ORANGE
CO005549RO		ROUGE
CO005549VE		VERT

CANNE À TRACER ERGONOMIQUE POUR BOMBE AÉROSOL



RÉF. ART.	DESCRIPTION
CO000460	CANNE À TRACER ERGONOMIQUE POUR BOMBE AÉROSOL DE PEINTURE, 1 ROUE

photos non contractuelles

CORDE À TRACER



RÉF. ART.	DESCRIPTION	COULEUR
CO005159	JAUNE 1KG	JAUNE

POUDRE À TRACER



RÉF. ART.	DESCRIPTION	COULEUR
CO005344		BLANC
CO005391	400GR	ROUGE
CO005390	1KG	ROUGE
CO004853	400GR	BLEU
CO004854	BLEU OUTREMER	BLEU

RECHARGE POUR CORDEAU TRACEUR



RÉF. ART.
CO005358

CÂBLE ANTI-FOUET



RÉF. ART.
CO000408

COLLIER À GRIFFE

POUR EAU OU AIR



RÉF. ART.	DESCRIPTION	DIAMETRE
CO001219	D.26MM	D 36 MM

COLLIER À OREILLES

POUR TUYAU EAU OU AIR



RÉF. ART.	DESCRIPTION	DIAMETRE
CO001220	D.31 À 34MM	D 31/34 MM

COLLIER BANDE AJOURNÉE DE SERRAGE L.8MM



RÉF. ART.	DIAMETRE
CO001389	D 10/16 MM
CO001388	D 14/24 MM
CO001390	D 18/28 MM

COLLIER DE SERRAGE



RÉF. ART.	DESCRIPTION
CO001394	D.17-20MM KIT DE 25
CO001244	POUR TUYAU D'EAU OU D'AIR

RACCORD EXPRESS

POUR TUYAU EAU OU AIR



RÉF. ART.	DESCRIPTION	DIAMETRE
CO003767	D.19MM	
CO005789	D.6MM	D 6 MM

photos non contractuelles

RACCORD FEMELLE À TÊTE DE CHAT

POUR TUYAU EAU OU AIR



RÉF. ART.	DESCRIPTION
CO003779	D.15-21MM
CO003780	D.20-27MM
CO003781	D.26-34MM

RACCORD MÂLE À TÊTE DE CHAT

POUR TUYAU EAU OU AIR



RÉF. ART.	DESCRIPTION
CO003782	D.15-21MM
CO003783	D.20-27MM
CO003784	D.26-34MM

RACCORD RAPIDE FEMELLE

ATLAS COPCO



POUR TUYAU EAU OU AIR

RÉF. ART.	DESCRIPTION
CO003774	ANNELÉ REF 8202112060
CO003773	FILETAGE MÂLE M15 REF 8202112097

RACCORD RAPIDE MÂLE

ATLAS COPCO



POUR TUYAU EAU OU AIR

RÉF. ART.	DESCRIPTION
CO003775	ANNELE REF 8202122077
CO003776	FILETAGE FEMELLE 8202 1220 88
CO003777	FILETAGE MÂLE 8202 1220 27

RACCORD TYPE POMPIER



RÉF. ART.	DIAMETRE
CO006034	D 25 MM
CO006033	D 50 MM

BOMBE AÉROSOL SILISAF SPRAYMIG SIB



RÉF. ART.
CO005798

ROBINET PÉTROLIER 20/27



RÉF. ART.
CO003910

COLONNE MONTANTE D'AIR



RÉF. ART.
CO005656

ROULEAU DE TEFLON



RÉF. ART.
CO004012

CONNECTEUR ENTRE RACCORD RAPIDE ET SORTIE

ENTREE RACCORD RAPIDE / SORTIE TETE DE CHAT



RÉF. ART.	DESCRIPTION
CO005562	TDC L,0,8M

photos non contractuelles

CONNECTEUR Y ENTRE COMPRESSEUR ET SORTIE DE RACCORD RAPIDE



RÉF. ART.
CO005563

VANNE À SPHÈRE 20 X 27

POUR TUYAU EAU OU AIR



RÉF. ART.	DESCRIPTION
CO004571	FEMELLE / FEMELLE
CO004572	MÂLE / MÂLE
CO004576	MÂLE / FEMELLE

VANNE Y ÉQUIPÉE 3 VOIES

POUR TUYAU EAU OU AIR



RÉF. ART.	DESCRIPTION
CO004580	, 1 ENTRÉE EN 3/4", 2 SORTIES EN 1/2"

VANNE À SPHÈRE 26 X 34

POUR TUYAU EAU OU AIR



RÉF. ART.	DESCRIPTION
CO004573	FEMELLE / FEMELLE
CO004574	MÂLE / MÂLE
CO004577	MÂLE / FEMELLE

VANNE À SPHÈRE 15 X 21

POUR TUYAU EAU OU AIR



RÉF. ART.	DESCRIPTION
CO004579	FEMELLE / FEMELLE
CO004570	MÂLE / MÂLE
CO004575	MÂLE / FEMELLE

DÉTENDEUR ACÉTYLÈNE



RÉF. ART.
CO001804

photos non contractuelles

DÉTENTEUR OXYGÈNE



RÉF. ART.
CO001806

ELECTRODE BASIC NF 510



RÉF. ART.	DESCRIPTION	LONGUEUR	DIAMETRE
CO002077	D.2,5MM	L 350 MM	D 2,5 MM
CO002078	D.3,2MM	L 450 MM	D 3,15 MM

ELECTRODE RUTILE SAFER G48N



RÉF. ART.	DESCRIPTION	LONGUEUR	DIAMETRE
CO002080	ELECTRODE RUTILE D.3,15MM SAFER G48N	L 450 MM	D 3,15 MM

ELECTRODE SAFER G48N ENROBÉE



RÉF. ART.	DESCRIPTION	LONGUEUR	DIAMETRE
CO002079	RUTILE D.2,5MM	L 350 MM	D 2,5 MM
CO002081	RUTILE D.4MM	L 350 MM	D 4 MM

JOINT TORIQUE POUR RACCORD RAPIDE



RÉF. ART.
CO002492

LANCE STOPNET RACCORD

ARRÊT EN AUTOMATIQUE POUR EAU OU AIR - PREVOIR RACCORD RAPIDE FEMELLE CO003774



RÉF. ART.	DESCRIPTION
CO002695	LANCE STOPNET AVEC RACCORD RAPIDE MÂLE

photos non contractuelles

LANCE STOPNET

OUVERTURE SANS VANNE



RÉF. ART.	DESCRIPTION
CO002696	POUR EAU OU AIR AVEC RACCORD EXPRESS

PINCE PORTE ÉLECTRODE



POUR SOUDURE ELECTRIQUE

RÉF. ART.	DESCRIPTION
CO003533	POUR SOURDE ÉLECTRIQUE

PARE-FLAMME ANTI RETOUR



RÉF. ART.	DESCRIPTION
CO003410	ACÉTYLÈNE
CO003411	OXYGÈNE

RACCORD POUR BOUTEILLE ALTOP OXYGÈNE ACÉTYLÈNE



RÉF. ART.
CO003785

PINCE DE MASSE 300A



POUR SOUDURE ELECTRIQUE

RÉF. ART.
CO003525

photos non contractuelles

RACCORD RAPIDE + CLAPET LORMATIC

POUR SOUDURE



RÉF. ART.	DESCRIPTION
CO002476	POUR SOUDURE

TUYAU DE PROPANE + ROBINET



RÉF. ART.
CO002160

TÊTE DE COUPE CHALUMEAU



RÉF. ART.	DESCRIPTION
CO004252	COUPEUR PYROCOPT G1 10/10 ACETYLENE
CO004254	COUPEUR PYROCOPT G1 16/10 ACETYLENE
CO004255	COUPEUR PYROCOPT G1 20/10 ACETYLENE
CO004256	COUPEUR PYROCOPT G1 25/10 ACETYLENE
CO004257	COUPEUR PYROCOPT G1 30/10 ACETYLENE
CO004253	COUPEUR PYROCOPT G1 12/10 ACETYLENE

MARTEAU À PIQUER



RÉF. ART.	DESCRIPTION
OU002844	MANCHE BOIS

FIL RECUIT N°8



RÉF. ART.	DESCRIPTION	DIAMETRE
CO002248	D.8MM ROULEAU DE 5KG	D 8 MM

photos non contractuelles

RUBAN ADHÉSIF AT-5001



RÉF. ART.	DESCRIPTION
CO007780	L.100M L.50MM

ANTENNE DE CONTACT AERIEN



RÉF. ART.	DESCRIPTION
CO103830	MS-917 1,25M

AFFICHETTE PVC 0,3MM



RÉF. ART.	DESCRIPTION
CO101566	AFFICHETTE "CONDAMNATION BT" PVC 0,3MM 170X75MM
CO101565	AFFICHETTE "MAINTENANCE EN COURS" PVC 0,3MM 170X75MM

BANDEROLE "DANGER DE MORT"



RÉF. ART.
CO103534

ALIMENTATION+PICOT+EMBOUT

POUR RUBAN IN018533 DE 50M

RÉF. ART.	DESCRIPTION
CO940030	3000K POUR RUBAN LED

photos non contractuelles

BANDEROLE "INSTALLATIONS SOUS TENSION"



RÉF. ART.
CO103535

BANDEROLE "LIMITE ZONE DE TRAVAIL"



RÉF. ART.
CO103536

BARRETTE DE CONNEXION NYLBLOC

POUR RACCORDEMENT ELECTRIQUE



RÉF. ART.	DESCRIPTION
CO007033	NOIR SECTION 10 ²
CO007034	NOIR SECTION 16 ²
CO007031	NOIR SECTION 2,5 ²
CO007035	NOIR SECTION 25 ²
CO007032	NOIR SECTION 6 ²

BOÎTE DE DÉRIVATION

LEGRAND



RÉF. ART.	DESCRIPTION
CO007880	L.105MM L.105MM
CO007881	L.220MM L.170MM
CO007882	L.80MM L.80MM

photos non contractuelles

BOITIER CONNECTEUR 6 ENTRES



RÉF. ART.
CO103615

CADENAS DE CONSIGNATION



RÉF. ART.	DESCRIPTION
CO103533	50MM D.4MM CLE 111
CO010562	6MM AL230S111
CO007777	,ANSE 4MM AL240S111

CADENAS CONDAMNATION PLAST ROUGE ANSE METAL



RÉF. ART.	DESCRIPTION
CO103848	6MM CLE Z

MACARON DE CONSIGNATION AP470/1



RÉF. ART.
CO007778



**KIT DE CONDAMNATION TOUS
DISJONCTEURS**



we
life

RÉF. ART.
CO103609

**DISQUE POLYPLEX "APPAREIL
CONDAMNE"**



RÉF. ART.	DESCRIPTION
CO103537	100MM

POIGNEE DE MANIPULATION FUSIBLES



RÉF. ART.
CO103616

**CAPUCHON CAOUTCHOUC PR ISOL.
D'ARRET**



RÉF. ART.
CO103810

**CAPUCHON CAOUTCHOUC PR
ISOL.D'ALIGNEMENT**



RÉF. ART.
CO103809

photos non contractuelles

CAPUCHON ISOLANT



CAPUCHON ISOLANT 15X11MM POUR EXTREMITE DE CABLES LONGUEUR 10CM MP26B

RÉF. ART.	DESCRIPTION
CO010564	15X11MM LONGUEUR 10CM MP26B

CAPUCHON ISOLANT POUR CABLE



RÉF. ART.	DESCRIPTION
CO103811	POUR CABLE DE 4 A 10 MM ²
CO103812	POUR CABLE DE 10 A 35 MM ²
CO103813	POUR CABLE DE 16 A 70 MM ²
CO103814	POUR CABLE 25 A 120 MM ²
CO103815	POUR CABLE JUSQU'A 300MM ²

COFFRET MISE EN COURT CIRCUIT



RÉF. ART.	DESCRIPTION
CO103617	4*MC296P
CO103618	5*MC296P

COIN ISOLANT



RÉF. ART.
CO103621

COLLIER COLSON L.9MM

LEGRAND



RÉF. ART.	DESCRIPTION
CO007221	L.185MM
CO007222	L.262MM
CO007223	L.357MM

EMBASE À CHEVILLE POUR PERÇAGE

LEGRAND



RÉF. ART.	DESCRIPTION
CO007408	LEGRAND

photos non contractuelles

CONDAMNATEUR DE DISJONCTEURS



RÉF. ART.	DESCRIPTION
CO007757	861746

CONDAMNATEUR PLASTIQUE 3MM



RÉF. ART.	DESCRIPTION
CO010563	HAUTEUR 46MM ALP 4/3

CONDAMNATEUR DE MODULAIRES



RÉF. ART.	DESCRIPTION
CO103531	AV CORDON 5M

CONDAMNATEUR/DISJONCTEURS



RÉF. ART.	DESCRIPTION
CO103532	MOYEN DROIT

photos non contractuelles

CONTRÔLEUR VAT



RÉF. ART.	DESCRIPTION
CO007927	AVEC ROTOPHASE MS918ET

DETECTEUR BORNES CAPACITIVES



RÉF. ART.	DESCRIPTION
CO103578	10/30KV

DETECTEUR BASSE TENSION LED



RÉF. ART.	DESCRIPTION
CO103831	, IP2X,1000V + ROT PHASE

DETECTEUR DC V SUR PERCHE



RÉF. ART.	DESCRIPTION
CO103829	5M

photos non contractuelles

DETECTEUR DE TENSION DC 3500V



RÉF. ART.	DESCRIPTION
CO103827	
CO103828	SUR PERCHE 750MM

ECARTEUR POUR CABLE TORSADE



RÉF. ART.	DESCRIPTION
CO103622	

DETECTEUR ELEC CEI



RÉF. ART.	DESCRIPTION
CO103580	10/30KV EMB.C

EQUIPEMENT MISE A LA TERRE



RÉF. ART.	DESCRIPTION
CO103619	& CCT POUR ARMOIRE BT NF C18510
CO103836	MT815C 20KA IEC
CO103833	NEVERS PELICAN 4 ELEMENTS

EQUIPEMENT MISE EN COURT CIRCUIT



RÉF. ART.	DESCRIPTION
CO103832	BT 7 PINCES
CO103838	CEI MT-613 8KA
CO103842	PRISE 250A

photos non contractuelles

ETAU DE TERRE



RÉF. ART.	DESCRIPTION
CO103841	20KA + VISSERIE

**MALLETTE ACCESSOIRES POUR
MESUREUR**



RÉF. ART.
CO103844

JONCTION POUR SHUNTS

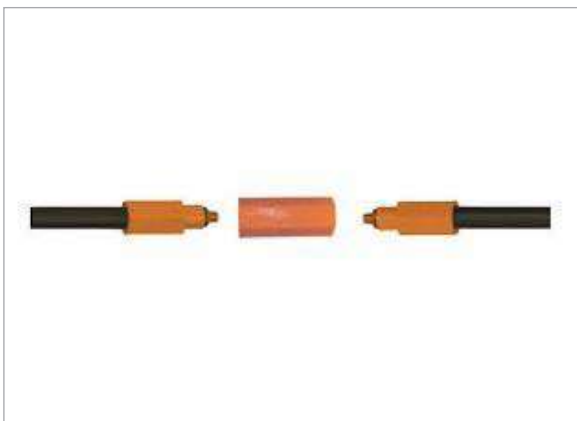

RÉF. ART.
CO103613

MESUREUR DE TERRE DIGITAL



RÉF. ART.
CO103843

photos non contractuelles

PERCHE ISOL ELEMNT INTERMEDIARE



RÉF. ART.	DESCRIPTION
CO103834	MT520

PERCHE POUR CC151K



RÉF. ART.	DESCRIPTION
CO103579	1,50M 45KV SS SUPPORT

PERCHE TELESCOPIQUE



RÉF. ART.	DESCRIPTION
CO103452	2 ELEM. 2,00M EMB.C
CO103582	DE MANOEUVRE
CO103581	EMB C
CO103454	PERCHE TÉLESCOPIQUE LONG. DÉPLOYÉE 1,5 M UMAX 45 KV EMBOUT C
CO103840	POLYESTER PT MT-800

PINCE COURT CIRCUIT



RÉF. ART.	DESCRIPTION
CO103839	40KA SUR PERCHE 0,4M

photos non contractuelles

HOUSSE POUR PERCHE MAX 1,95M



RÉF. ART.
OU103591

PIQUET DE TERRE



RÉF. ART.	DESCRIPTION	LONGUEUR
CO007030	L.150CM	L 150 CM
CO007756	PLEIN L.100CM	L 100 CM

PIQUET DE TERRE HEXAGONAL



RÉF. ART.	DESCRIPTION
CO103837	1,00M

PRISE FEMELLE BALS



RÉF. ART.	DESCRIPTION
CO003736	3+N+T 32 AMPERES
CO003737	3+T 16 AMPERES

photos non contractuelles

PRISE FEMELLE

LEGRAND



RÉF. ART.	DESCRIPTION
CO007868	IP44 220V POUR CABLE 3G2,5 ²

PROFILE CAOUTCHOUC NOIR



RÉF. ART.	DESCRIPTION
CO103817	1,00M

PRISE MALE

LEGRAND



RÉF. ART.	DESCRIPTION
CO003739	220V IP44 POUR CABLE 3G2,5 ²

PROFILE MATIERE ISOLANTE



	Référence	Dimensions (mm)	Masse (kg)
	MP-31	5000 x 27 x 27	0,7

RÉF. ART.	DESCRIPTION
CO103816	5M

PRISE MALE BALS



RÉF. ART.	DESCRIPTION
CO003740	3+N+T 32 AMPERES
CO003741	3+T 16 AMPERES

photos non contractuelles

SAC DE TRANSPORT PR TAPIS



RÉF. ART.	DESCRIPTION
CO103801	1,10M

SAC POUR CAPUCHONS D'ISOLATEUR

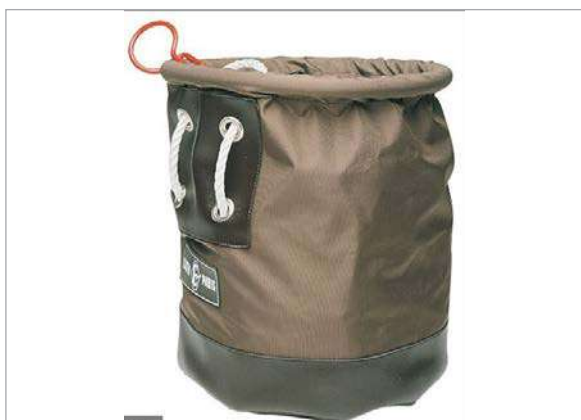

RÉF. ART.	DESCRIPTION
CO103823	

SCOTCH POUR ÉLECTRICIEN



RÉF. ART.	COULEUR
CO008172GS	GRIS
CO008172OR	ORANGE
CO008172BL	BLEU
CO008172MA	MARRON
CO008172NO	NOIR
CO008172RO	ROUGE
CO008172VE	VERT
CO008172VJ	VERT/JAUNE
CO007198	MULTICOULEURS

SHUNT SOUPLE H07RNF



RÉF. ART.	DESCRIPTION
CO103614	35MM² 3,00M

photos non contractuelles

TOURET 3 CABLES



RÉF. ART.	DESCRIPTION
CO103835	PR MT-508

TENDEUR POUR CABLES ISOLES



RÉF. ART.	DESCRIPTION
CO103635	17/22 MM
CO103634	3,5/14MM
CO103636	33/38 MM

ERGO'APP

PÔLE ERGO BYCN

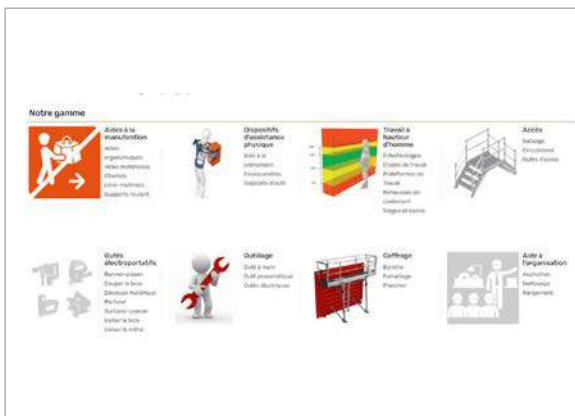

Outil d'aide à la décision permettant d'aider les collaborateurs à choisir les meilleurs outils, matériels ou matériaux selon un besoin et un contexte. Pour chaque produit, l'app propose une carte d'identité détaillée (caractéristiques techniques, photos, liens utiles) et précise pour quel type de tâches il est destiné. Evaluation sur la base de 5 critères : Amélioration de la sécurité, Apport sur la santé, Gain de productivité Intuitivité Poids < 15 kg

RÉF. ART.	DESCRIPTION
ERGO'APP	https://ergoapp.bouygues-construction.com/?lang=fr

photos non contractuelles

AIMANT MONOBLOC EN POLYURÉTHANE

2 AIMANTS- INSERT TARAUDE POUR CONE DE BLOCAGE

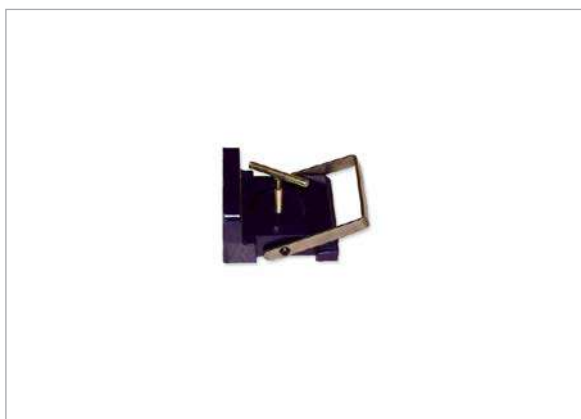

RÉF. ART.

CO007781

ELINGUE CABLE GAINÉ Ø3



RÉF. ART.	DESCRIPTION	LONGUEUR	DIAMETRE
CO010749	- 600MM AVEC 2 BOUCLES + MOUSQUETON	L 60 CM	D 3 MM

PINCE ACIER POUR BENNE À BÉTON



RÉF. ART.	DESCRIPTION
CO005782	POUR EVITER LES FUITES DE LAITANCE LORS DES MANŒUVRES DE BENNE A BETON

TUYAU DE BENNE À BÉTON



RÉF. ART.	DESCRIPTION	DIAMETRE
CO017853	L.3ML	D 200 MM
CO017854		D 250 MM
CO017864	AVEC OEILLETS DE FIXATION	D 250 MM
CO106057	GOULOTTE A BETON DIAM 250 LONGUEUR 3ML AVEC SYSTEME AIMANT	
CO112969	KIT POUR CONVERSION GOULOTTE AIMANTEE	
CO112953	KIT 2 CORDES BENNE A BETON	

COLLIER DE SERRAGE TUYAU BENNE À BÉTON



RÉF. ART.	DIAMETRE
CO005892	D 200 MM
CO001393	D 250 MM

photos non contractuelles

RONDELLE DE BANCHE BRONZE

JUSQU'À ÉPUISEMENT



RÉF. ART.	DESCRIPTION
CO009452	D.92MM, ALÉSAGE 40MM

ECROU EMBASE FLOTTANTE

we love life



TIGE ONESHOOT
36/38 POUR ONESHOOT

RÉF. ART.	DESCRIPTION
CO017129	ECROU EN BASE FLOTTANTE

PLATINE POUR TIGE "ONE SHOOT"

we love life



TIGE ONESHOOT

RÉF. ART.	DESCRIPTION
CO017128	PLATINE EPI POUR SYSTÈME RAPIDE RÉUTILISABLE "ONE SHOOT"

TIGE ONESHOOT

we love life



RÉF. ART.	DESCRIPTION
CO017130	L.500MM

photos non contractuelles

ELINGUE CÂBLE POUR MARCHÉ ENEDIS

TRUSTEAM

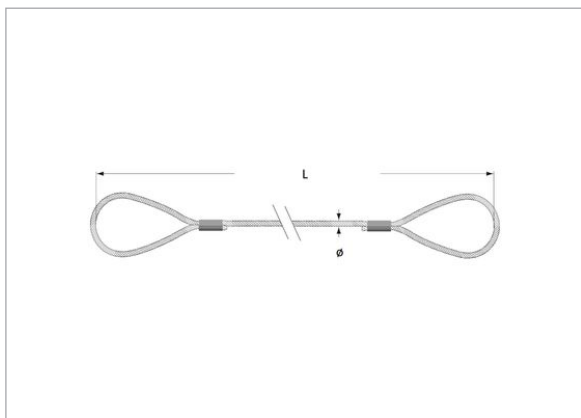

ELINGUE CÂBLE BOUCLES MANCHONNÉES POUR LEVAGE DE POTEAUX BÉTON MARCHÉ ENEDIS

RÉF. ART.	DESCRIPTION
CO103918	- D14MM - CMU 1.75T - LG 1M
CO103921	- D14MM - CMU 1.75T - LG 3M
CO103922	- D14MM - CMU 1.75T - LG 4M
CO103923	- D24MM - CMU 5T - LG 3M
CO103917	-D14MM -CMU 1.75T -LG 0,50M
CO103919	-D14MM -CMU 1.75T -LG 1,50M
CO103920	-D14MM -CMU 1.75T -LG 2,50M

ESTROPE SYNTHQ. PLATE PR LEV DE POTX BÉTON

TRUSTEAM



RÉF. ART.	DESCRIPTION
CO103924	-CMU 5T -LG : 3M
CO103925	-CMU 5T -LG : 4M

ESTROPE ACIER PR LEV POTEAUX BÉTON

TRUSTEAM



RÉF. ART.	DESCRIPTION
CO103904	-D15MM -CMU 3.8T -LG 3M
CO103905	-D15MM -CMU 3.8T -LG3,2M
CO103906	-D15MM -CMU 3.8T -LG3,6M
CO103907	-D15MM -CMU 5T -LG 4M
CO103908	-D15MM -CMU 5T -LG 5M
CO103909	-D15MM -CMU 6T -LG 4M
CO103911	-D15MM -CMU 9,5T -LG 3M
CO103910	-D15MM -CMU 9,5T -LG2,5M
CO103912	-D16MM -CMU 3.8T -LG 4M
CO103913	-D25MM -CMU 8.3T -LG 3M
CO103915	-D26MM -CMU10.6T -LG1,5M
CO103916	-D27MM -CMU 7T -LG 3M
CO103914	-D26MM -CMU10.6T -LG1,25M

photos non contractuelles

ESTROPE -ELINGUE SANGLE PLATE B2 TURBO

TEDESCO



CO112351 + CMU / LONGUEUR

RÉF. ART.	DESCRIPTION
CO1123511T/1ML	1T/1ML
CO1123511T/2ML	1T/2ML
CO1123511T/3ML	1T/3ML
CO1123511T/4ML	1T/4ML
CO1123511T/5ML	1T/5ML
CO1123511T/6ML	1T/6ML
CO1123511T/8ML	1T/8ML
CO1123512T/1ML	2T/1ML
CO1123512T/2ML	2T/2ML
CO1123512T/3ML	2T/3ML
CO1123512T/4ML	2T/4ML
CO1123512T/5ML	2T/5ML
CO1123512T/6ML	2T/6ML
CO1123512T/8ML	2T/8ML
CO1123512T/10ML	2T/10ML
CO1123513T/1ML	3T/1ML
CO1123513T/2ML	3T/2ML
CO1123513T/3ML	3T/3ML
CO1123513T/4ML	3T/4ML
CO1123513T/5ML	3T/5ML
CO1123513T/6ML	3T/6ML
CO1123513T/8ML	3T/8ML
CO1123513T/10ML	3T/10ML
CO1123514T/2ML	4T/2ML
CO1123514T/3ML	4T/3ML
CO1123514T/4ML	4T/4ML
CO1123514T/5ML	4T/5ML
CO1123514T/6ML	4T/6ML
CO1123514T/8ML	4T/8ML
CO1123514T/10ML	4T/10ML
CO1123515T/2ML	5T/2ML
CO1123515T/3ML	5T/3ML
CO1123515T/4ML	5T/4ML
CO1123515T/5ML	5T/5ML
CO1123515T/6ML	5T/6ML
CO1123515T/8ML	5T/8ML
CO1123515T/10ML	5T/10ML
CO1123516T/2ML	6T/2ML
CO1123516T/3ML	6T/3ML
CO1123516T/4ML	6T/4ML
CO1123516T/5ML	6T/5ML
CO1123516T/6ML	6T/6ML
CO1123516T/8ML	6T/8ML
CO1123516T/10ML	6T/10ML

»

RÉFÉRENCE ARTICLE DESCRIPTION

CO1123518T/3ML	8T/3ML
CO1123518T/4ML	8T/4ML
CO1123518T/5ML	8T/5ML
CO1123518T/6ML	8T/6ML
CO1123518T/8ML	8T/8ML
CO1123518T/10ML	8T/10ML
CO11235110T/3ML	10T/3ML
CO11235110T/4ML	10T/4ML
CO11235110T/5ML	10T/5ML
CO11235110T/6ML	10T/6ML
CO11235110T/8ML	10T/8ML
CO11235110T/10ML	10T/10ML

ESTROPE SYNTHETIQUE PLATE DOUBLE ENEDIS

TEDESCO



RÉF. ART. DESCRIPTION

CO103941	2T/2.5ML
CO1123512T/3ML	2T/3ML
CO103943	2T/3.5ML
CO103944	3T/2.6ML
CO1123513T/3ML	3T/3ML
CO103946	3T/4.5ML

photos non contractuelles

ESTROPE - ELINGUE RONDE TURBO



CO112353 + CMU / LONGUEUR

RÉF. ART.	DESCRIPTION
CO1123531T/1ML	1T/1ML
CO1123531T/2ML	1T/2ML
CO1123531T/3ML	1T/3ML
CO1123531T/4ML	1T/4ML
CO1123532T/0.5ML	2T/0,5ML
CO1123532T/1ML	2T/1ML
CO1123532T/2ML	2T/2ML
CO1123532T/3ML	2T/3ML
CO1123532T/4ML	2T/4ML
CO1123532T/6ML	2T/6ML
CO1123533T/1ML	3T/1ML
CO1123533T/2ML	3T/2ML
CO1123533T/3ML	3T/3ML
CO1123533T/4ML	3T/4ML
CO1123533T/6ML	3T/6ML
CO1123534T/1ML	4T/1ML
CO1123534T/1.5ML	4T/1.5ML
CO1123534T/2ML	4T/2ML
CO1123534T/3ML	4T/3ML
CO1123534T/4ML	4T/4ML
CO1123534T/6ML	4T/6ML
CO1123535T/1ML	5T/1ML
CO1123535T/3ML	5T/3ML
CO1123535T/4ML	5T/4ML
CO1123535T/6ML	5T/6ML
CO1123536T/1ML	6T/1ML
CO1123536T/3ML	6T/3ML
CO1123536T/4ML	6T/4ML
CO1123536T/6ML	6T/6ML
CO1123538T/6ML	8T/6ML
CO11235310T/3ML	10/3ML
CO11235310T/5ML	10T/5ML
CO11235310T/6ML	10T/6ML

ELINGUE CHAINE 1 BRIN

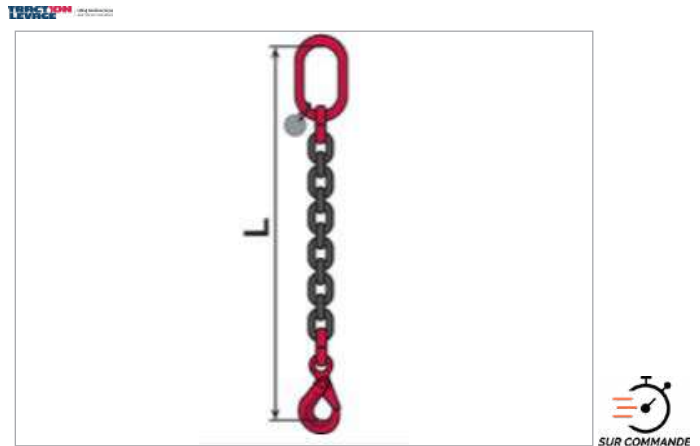

GRADE 80 : CO112354 + CMU / LONGUEUR

GRADE 100 : CO112355 + CMU / LONGUEUR

RÉF. ART.	DESCRIPTION
CO1123542T/1ML	GRADE 80 2T/1ML
CO1123542T/2ML	GRADE 80 2T/2ML
CO1123542T/3ML	GRADE 80 2T/3ML
CO1123542T/4ML	GRADE 80 2T/4ML
CO1123542T/5ML	GRADE 80 2T/5ML
CO1123543T15/1ML	GRADE 80 3T15/1ML
CO1123543T15/2ML	GRADE 80 3T15/2ML
CO1123543T15/3ML	GRADE 80 3T15/3ML
CO1123543T15/4ML	GRADE 80 3T15/4ML
CO1123543T15/5ML	GRADE 80 3T15/5ML
CO1123545T3/1ML	GRADE 80 5T3/1ML
CO1123545T3/2ML	GRADE 80 5T3/2ML
CO1123545T3/3ML	GRADE 80 5T3/3ML
CO1123545T3/4ML	GRADE 80 5T3/4ML
CO1123545T3/5ML	GRADE 80 5T3/5ML
CO1123548T/1ML	GRADE 80 8T/1ML
CO1123548T/2ML	GRADE 80 8T/2ML
CO1123548T/3ML	GRADE 80 8T/3ML
CO1123548T/4ML	GRADE 80 8T/4ML
CO1123548T/5ML	GRADE 80 8T/5ML
CO1123554T/1ML	GRADE 100 4T/1ML
CO1123554T/2ML	GRADE 100 4T/2ML
CO1123554T/3ML	GRADE 100 4T/3ML
CO1123554T/4ML	GRADE 100 4T/4ML
CO1123554T/5ML	GRADE 100 4T/5ML
CO1123556T7/1ML	GRADE 100 6T7/1ML
CO1123556T7/2ML	GRADE 100 6T7/2ML
CO1123556T7/3ML	GRADE 100 6T7/3ML
CO1123556T7/4ML	GRADE 100 6T7/4ML
CO1123556T7/5ML	GRADE 100 6T7/5ML
CO103896	1T5 1.5ML POUR MASSIF DE CANDELABRE
CO103894	1ML POUR PINCE AUTOMATIQUE 3T

photos non contractuelles

ELINGUE CHAINE 2 BRINS

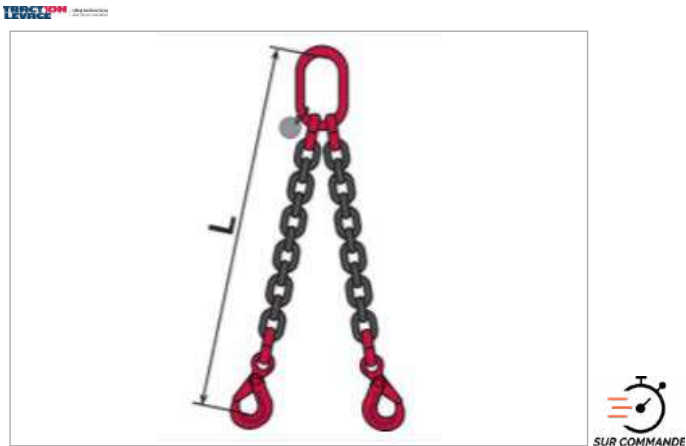

GRADE 80 : CO112356 + CMU / LONGUEUR

GRADE 100 : CO112357 + CMU / LONGUEUR

RÉF. ART.	DESCRIPTION
CO1123564T25/1ML	GRADE 80 4T25/1ML
CO1123564T25/2ML	GRADE 80 4T25/2ML
CO1123564T25/3ML	GRADE 80 4T25/3ML
CO1123564T25/4ML	GRADE 80 4T25/4ML
CO1123564T25/5ML	GRADE 80 4T25/5ML
CO1123564T25/6ML	GRADE 80 4T25/6ML
CO1123567T5/1ML	GRADE 80 7T5/1ML
CO1123567T5/2ML	GRADE 80 7T5/2ML
CO1123567T5/3ML	GRADE 80 7T5/3ML
CO1123567T5/4ML	GRADE 80 7T5/4ML
CO1123567T5/5ML	GRADE 80 7T5/5ML
CO1123567T5/6ML	GRADE 80 7T5/6ML
CO11235611T2/1ML	GRADE 80 11T2/1ML
CO11235611T2/2ML	GRADE 80 11T2/2ML
CO11235611T2/3ML	GRADE 80 11T2/3ML
CO11235611T2/4ML	GRADE 80 11T2/4ML
CO11235611T2/5ML	GRADE 80 11T2/5ML
CO11235611T2/6ML	GRADE 80 11T2/6ML
CO1123575T6/1ML	GRADE 100 5T6/1ML
CO1123575T6/2ML	GRADE 100 5T6/2ML
CO1123575T6/3ML	GRADE 100 5T6/3ML
CO1123575T6/4ML	GRADE 100 5T6/4ML
CO1123575T6/5ML	GRADE 100 5T6/5ML
CO1123575T6/6ML	GRADE 100 5T6/6ML
CO1123579T5/1ML	GRADE 100 9T5/1ML
CO1123579T5/2ML	GRADE 100 9T5/2ML
CO1123579T5/3ML	GRADE 100 9T5/3ML
CO1123579T5/4ML	GRADE 100 9T5/4ML
CO1123579T5/5ML	GRADE 100 9T5/5ML
CO1123579T5/6ML	GRADE 100 9T5/6ML
CO11235714T/1ML	GRADE 100 14T/1ML
CO11235714T/2ML	GRADE 100 14T/2ML
CO11235714T/3ML	GRADE 100 14T/3ML
CO11235714T/4ML	GRADE 100 14T/4ML
CO11235714T/5ML	GRADE 100 14T/5ML
CO11235714T/6ML	GRADE 100 14T/6ML
CO103888	1T5 /2.10ML
CO103891	3T/2.7ML

ELINGUE CHAINE 3 BRINS

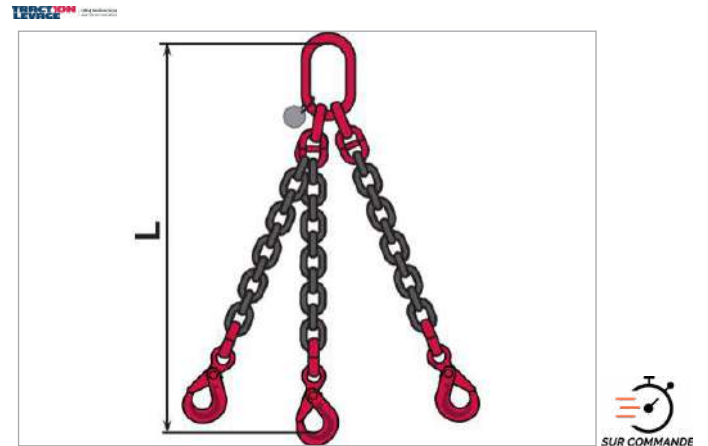

RÉF. ART.	DESCRIPTION
CO103893	LEVAGE BUSES 1T5 / 1.5ML

ELINGUE CHAINE 4 BRINS

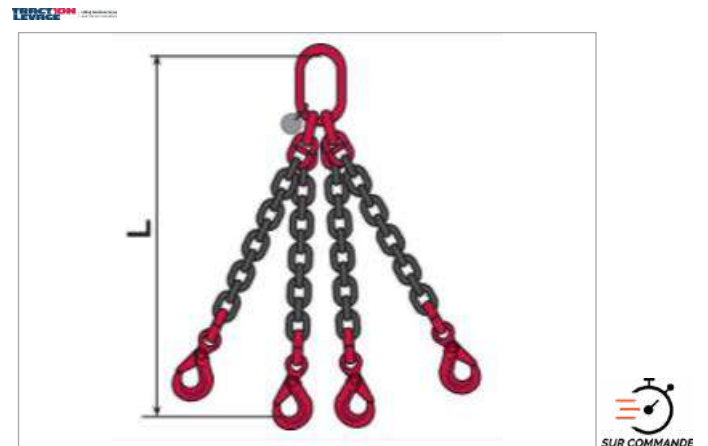

GRADE 80 : CO112358 + CMU / LONGUEUR

GRADE 100 : CO112359 + CMU / LONGUEUR

RÉF. ART.	DESCRIPTION
CO1123586T7/4ML	GRADE 80 6T7/4ML
CO1123586T7/6ML	GRADE 80 6T7/6ML
CO1123586T7/8ML	GRADE 80 6T7/8ML
CO11235811T2/4ML	GRADE 80 11T2/4ML
CO11235811T2/6ML	GRADE 80 11T2/6ML
CO11235811T2/8ML	GRADE 80 11T2/8ML
CO1123598T/4ML	GRADE 100 8T/4ML
CO1123598T/6ML	GRADE 100 8T/6ML
CO1123598T/8ML	GRADE 100 8T/8ML
CO11235914T/4ML	GRADE 100 14T/4ML
CO11235914T/6ML	GRADE 100 14T/6ML
CO11235914T/8ML	GRADE 100 14T/8ML
CO103895	1T5/1ML AVEC RACCOURCISSEUR POU LEVAGE DE TRANSFORMATEUR
CO103892	3T/2,70ML

photos non contractuelles

KIT ELINGUES POUR CONTAINEURS

TRUSIPON



RÉF. ART.	DESCRIPTION
CO005661	JEU DE 4 + ACCESSOIRES

ELINGUE CABLE 1 BRIN BOUCLE SIMPLE MANCHONNEE

TRUSIPON

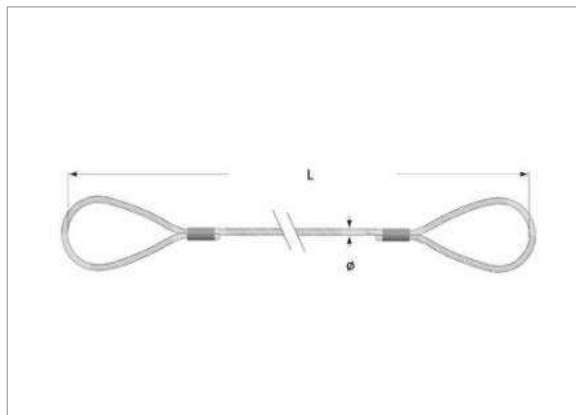

CO112360 + CMU / LONGUEUR

RÉF. ART.	DESCRIPTION
CO1123601T/1ML	1T/1ML
CO1123601T/2ML	1T/2ML
CO1123601T/3ML	1T/3ML
CO1123601T/4ML	1T/4ML
CO1123601T/5ML	1T/5ML
CO1123601T4/1ML	1T4/1ML
CO1123601T4/2ML	1T4/2ML
CO1123601T4/3ML	1T4/3ML
CO1123601T4/4ML	1T4/4ML
CO1123601T4/5ML	1T4/5ML
CO1123602T12/1ML	2T12/1ML
CO1123602T12/2ML	2T12/2ML
CO1123602T12/3ML	2T12/3ML
CO1123602T12/4ML	2T12/4ML
CO1123602T12/5ML	2T12/5ML
CO1123602T7/1ML	2T7/1ML
CO1123602T7/2ML	2T7/2ML
CO1123602T7/3ML	2T7/3ML
CO1123602T7/4ML	2T7/4ML
CO1123602T7/5ML	2T7/5ML
CO1123604T5/1ML	4T5/1ML
CO1123604T5/2ML	4T5/2ML
CO1123604T5/3ML	4T5/3ML
CO1123604T5/4ML	4T5/4ML
CO1123604T5/5ML	4T5/5ML

photos non contractuelles

MAILLON D'ASSEMBLAGE

TEPSTEPM



CO112361 + CMU

RÉF. ART.	DESCRIPTION
CO1123612T/	2T
CO1123613T15/	3T15
CO1123615T3/	5T3
CO1123614T/	4T
CO1123616T7/	6T7

MANILLE LYRE

TEPSTEPM



CO112362 + CMU

RÉF. ART.	DESCRIPTION
CO1123621T/	1T
CO1123622T/	2T
CO1123623T25/	3T25
CO1123624T75/	4T75
CO1123626T5/	6T5

MANILLES

TEPSTEPM



RÉF. ART.	DESCRIPTION
CO103898	- CMU 1.5 T
CO103899	- CMU 2.5 T
CO103900	- CMU 4 T
CO103901	- CMU 5 T

ANNEAU DE LEVAGE

TEPSTEPM



POUR POSTES TRANSFOS, REGARDS...

RÉF. ART.	DESCRIPTION
CO103887	1T5
CO103889	2T5
CO103890	5T

photos non contractuelles

ANNEAU DE LEVAGE HR

TRUST 2000



RÉF. ART.	DESCRIPTION
CO112383	D8 0,4T
CO112384	D10 0,7T
CO112385	D12 1T
CO112386	D14 1,2T
CO112387	D16 1T5
CO112388	D18 2T
CO112389	D20 2T5

ANNEAU DE LEVAGE DOUBLE ARTICULATION DSR UP

TRUST 2000



RÉF. ART.	DESCRIPTION
CO112390	M8 0,4T
CO112391	M10 0,7T
CO112392	M14 1,4T
CO112393	M16 2T
CO112394	M20 2,9T
CO112395	M22 3,5T
CO112396	M30 6T
CO112397	M36 8T

ANNEAU DE LEVAGE STARCON

TRUST 2000



RÉF. ART.	DESCRIPTION
CO112398	1,0-1,3T
CO103889	1,5-2,5T
CO103890	3-5T
CO112399	7,5-10T

CROCHET À ÉMERILLON

TRUST 2000



RÉF. ART.	DESCRIPTION
CO103902	- CMU 3.15 T
CO103903	- CMU 5.3 T

photos non contractuelles

CROCHET

TRISTIMO la marque de distribution de



RÉF. ART.	DESCRIPTION
CO010199	GKO 3 5T3
CO104024	4T GR 100
CO100824	6T7 GR 100
CO104174	YO 3 5T3
CO020965	YC 3 5T3

VERROU DE RECHANGE

TRISTIMO la marque de distribution de



RÉF. ART.	DESCRIPTION
CO004589	GKO 3 5T3
CO021079	4T GR 100
CO021080	6T7 GR 100
CO021082	YC 1 2T
CO021083	YC 2 3T15

PINCE TRICROCHET A SERRAGE LIBRE LEVAGE BUSES

TRISTIMO la marque de distribution de



RÉF. ART.	DESCRIPTION
HS990261	GD1500 CMU 1T5 1,2ML SERRAGE 40-120
HS112180	GD3000 CMU 3T 1,5ML SERRAGE 80-180
CO103897	POUR LEVAGE DE BUSES 2T5 DIMA BUSES 625-1500MM

SANGLE ET TENDEUR À CLIQUET

TRISTIMO la marque de distribution de

RÉF. ART.	DESCRIPTION
CO103947	- LG 8 M - LARG 50 MM

SANGLE + CLIQUET DE CAMION

TRISTIMO la marque de distribution de



TL3000

RÉF. ART.	DESCRIPTION	LONGUEUR
IN004056	TMU 2T L.9ML	L 9 M

photos non contractuelles

SANGLE A CLIQUET



RÉF. ART.	DESCRIPTION
IN010910	LARGEUR 25 LONGUEUR 5M

SCELLE CABLE

NUMEROTATION CONSECUTIVE



RÉF. ART.	DESCRIPTION	LON- GUEUR	DIAMETRE
CO020623	1,5MM LG.250MM BOUYGUES CONSTRUCTION ROUGE		
CO017978	1,5MM LG.250MM BOUYGUES CONSTRUCTION VERT		
CO101619	2021 VIOLET 1,5MM LG.250MM BYCN VIOLET		
CO018648	SCELLÉ CÂBLE BLEU 1,5MM LONG 250MM BY CN NUM. CONS.	VERT L 25 CM	D 1,5 MM

SERRE CABLE GALVA

TRUST



RÉF. ART.	DESCRIPTION
CO004087	SERRE CABLE Ø10 GALVA

TENDEUR POUR CABLES ISOLES

CATU

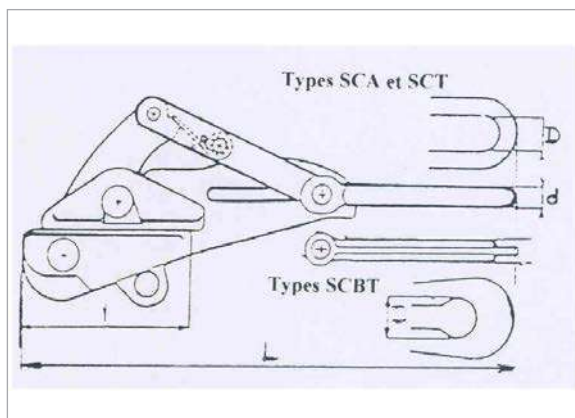

RÉF. ART.	DESCRIPTION
CO103635	17/22 MM
CO103634	3,5/14MM
CO103636	33/38 MM

photos non contractuelles

DYNAMOMETRE



RÉF. ART.	DESCRIPTION
OU103633	1000DAN MECANIQUE

PALAN À CHAÎNE



RÉF. ART.	DESCRIPTION
CO103948	- CMU 1 T - LG 3 M

GRENOUILLE TIRVIT



RÉF. ART.	DESCRIPTION
OU103627	7 - 15 MM

PALAN A CABLETTE



RÉF. ART.	DESCRIPTION
OU103641	1,50M-1000DAN

photos non contractuelles

PALAN TST BT



RÉF. ART.	DESCRIPTION
OU103637	CMU 240 DAN CORDE 25M

PALAN TREUIL À CÂBLE

SIBILLE



RÉF. ART.	DESCRIPTION
OU105859	500/1000 DAN HAUTEUR 4/2 M
OU105860	800/1600 DAN HAUTEUR 6,6/3,3 M

PALAN MANUEL A CHAINE HADEF 8/12



RÉF. ART.	DESCRIPTION
OU010224	CMU 0,5T LEVEE 3ML
OU010225	CMU 1T LEVEE 3ML
OU010226	CMU 2T LEVEE 3ML
OU010227	CMU 3T LEVEE 3ML
OU010229	CMU 5T LEVEE 3ML

TENDEUR TIRVIT



RÉF. ART.	DESCRIPTION
OU103628	400DAN
OU103629	600DAN

photos non contractuelles

CONSOLE À SANGLE PR POULIE DE DEROULAGE



RÉF. ART.
IN103639

CRAVATE D'ANCRAGE



RÉF. ART.	DESCRIPTION
IN103642	0,80M

CROCHET POUR CORDE DE SERVICE



RÉF. ART.
IN103632

TIRFOR 3200/5000 KG CABLE 30 M



RÉF. ART.
OU103630

photos non contractuelles

CAPUCHONS DE PROTECTION

SOFOF TALIAPLAST



RÉF. ART.	DESCRIPTION
SI000491	EN ACIER D.6-16CM
SI000490	ACIER D.16-32MM

GOUTIÈRE DE PROTECTION



RÉF. ART.	DESCRIPTION	LONGUEUR
SI002382	POUR FER À BÉTON L.1ML	L 100 CM

FILET DE PROTECTION



RÉF. ART.	DESCRIPTION	LONGUEUR	LARGEUR
CO005963	FILET DE GRAVATS VERT L.100M L0,3M	L 100 M	I 300 CM
CO005962	BLANC GRAVATS MICROMAILLE L.100M L0,3M	L 100 M	I 300 CM

POLYANE



RÉF. ART.	DESCRIPTION	LARGEUR
CO005852	150 MICRONS 340M ²	I 300 CM
CO005855	150 MICRONS L.3M 30KG	I 300 CM
CO005512	200 MICRONS 240M ²	I 300 CM
CO005853	200 MICRONS L.3M 30KG	I 300 CM
CO005857	300 MICRONS L.6M 30KG	I 600 CM
CO005856	ARMÉ TRANSLUCIDE	
CO005854	NOIR 150 MICRONS L.6M 50KG / 6m / 342 m ²	I 600 CM

SAC À GRAVATS TISSÉ



RÉF. ART.	DESCRIPTION	LARGEUR
CO006032	L.90CM L.50CM	I 90 CM

photos non contractuelles

SAC BIG BAG



RÉF. ART.	DESCRIPTION
CO004038	DE RÉCUPÉRATION 1000L
CO004037	DE RÉTENTION L.95MM L.95MM 2000KG

SUR COMMANDE = soumis à des délais supérieurs à ceux habituels

SUR COMMANDE = SOUMIS À DES DÉLAIS SUPÉRIEURS À CEUX HABITUELS



RÉF. ART.
SUR COMMANDE

SAC POLYPRO POUR GRAVAT

SAC POLYPRO POUR GRAVATS 60 X 87 CM - PRIX AU SAC - VENDU AU ROULEAU DE 10 -



RÉF. ART.	DESCRIPTION
CO018508	S L.87CM L.60CM -10 Rlx

SIGNIFICATION DISTRIPLUS & WE LOVE LIFE



RÉF. ART.
PICTOS

photos non contractuelles

ASPIRATEUR UNIVERSEL VC 20 CLASSE M X



nouvelle génération, remplace le EL004839 prévoir sac : EL101080

RÉF. ART.	DESCRIPTION	REFERENCE FABRICANT
EL101069	ASPIRATEUR UNIVERSEL VC 20M-X 230V	2220068

ASPIRATEUR UNIVERSEL VC 40 CLASSE M X



nouvelle génération, remplace le EL004840 prévoir sac : EL101083

RÉF. ART.	DESCRIPTION	REFERENCE FABRICANT
EL101070	ASPIRATEUR UNIVERSEL VC 40M-X 230V	2220069

ASPIRATEUR UNIVERSEL VC 20 CLASSE M Y (hybride)



HYBRIDE filaire et sur batterie, remplace le EL008692 prévoir sac : EL004023

RÉF. ART.	DESCRIPTION	REFERENCE FABRICANT
EL010985	ASPIRATEUR UNIVERSEL VC 20-UM-Y 230V - filaire /batterie	2044379

ASPIRATEUR UNIVERSEL VC 40 CLASSE M Y (hybride)



HYBRIDE filaire et sur batterie, remplace le EL008693 prévoir sac : EL004024

RÉF. ART.	DESCRIPTION	REFERENCE FABRICANT
EL010986	ASPIRATEUR UNIVERSEL VC 40-UM-Y 230V filaire /batterie	2044394

photos non contractuelles

ASPIRATEUR UNIVERSEL VC 40 CLASSE H

HILTI



we
life
b
DISTRIPUS⁺

classe H

RÉF. ART.	DESCRIPTION	REFERENCE FABRICANT
EL920033	ASPIRATEUR UNIVERSEL VC 40H-XE 230V	2239564

ASPIRATEUR CLASSE H POUSSIÈRES DE SILICE

BOSCH



we
life
b
DISTRIPUS⁺

nouveau produit à venir - disponible 1er trimestre 2021

RÉF. ART.	DESCRIPTION
EL105902	BOSCH GAS 35 H AFC

ASPIRATEUR À BATTERIE DVC260Z
NU TYPE SAC À DOS

MAKITA



we
life
b
DISTRIPUS⁺

Classe L - Nécessite 2 batteries 18V + chargeur vendus séparément - **Nécessite un accord de la Prévention Santé Sécurité**

RÉF. ART.
EL010661

ASPIRATEUR MAKITA VC3211HX1
CLASSE H - POUSSIÈRES DE SILICE

MAKITA



we
life
b
DISTRIPUS⁺

RÉF. ART.
EL105889

photos non contractuelles

ASPIRATEUR VC3211MX1 CLASSE M

MAKITA



Aspirateur 1050 W 220 mbar classe M - Option potence pour fixation du tuyau par le haut

RÉF. ART.
EL008436

ASPIRATEUR CLEANTEC CTM 36 E AC

FESTOOL



RÉF. ART.	REFERENCE FABRICANT
EL102283	CTM36EAC

**ASPIRATEUR AC 1630 PM POUR EAU ET
POUSSIERES**



RÉF. ART.	PUISSANCE	REFERENCE FABRICANT
EL007647	Pu 1600 W	620914

photos non contractuelles

CONNECTEUR ASPIRATEUR

HILTI



ASPIRATEUR HILTI VC20 U (M) _ASPIRATEUR HILTI VC20 U Y (M)_ASPIRATEUR HILTI VC40 U (M)_ASPIRATEUR HILTI VC40 U Y (M)

Le chantier reste propre grâce à la collecte d'eau s'effectuant à la base des couronnes diamant lors du forage - compatible avec le recycleur d'eau DD-WMS 100

RÉF. ART.	REFERENCE FABRICANT
EL009054	2040612

PERCHE POUR TUYAU ASPIRATION POTENCE

MAKITA

we
life

ASPIRATEUR MAKITA VC3211 MX1 CLASSE M POUR ASPIRATEUR VC3211MX1

RÉF. ART.	DESCRIPTION
EL010456	PERCHE POUR TUYAU D'ASPIRATION POTENCE POUR ASPIRATEUR

TUYAU FLEXIBLE ASPIRATEUR MAKITA VC 3211M

MAKITA



RÉF. ART.
EL100663

FLEXIBLE 5 M AC 1600

SPIT



ASPIRATEUR SPIT AC 1630 PM

RÉF. ART.	REFERENCE FABRICANT
EL007709	644004

photos non contractuelles

KIT ACCESSOIRES AC 1630 PM



ASPIRATEUR SPIT AC 1630 PM
composé de: adaptateur eau/poussière, Brosse poussière, Raclette
eau, Poignée coudée, 2 Tubes rallonge - 1

RÉF. ART.	REFERENCE FABRICANT
EL007711	644030

SYSTEME DUSTER RECUP POUSSIERE



RÉF. ART.	REFERENCE FABRICANT
EL018168	54117

RACCORD EN Y D50 SV-AS/D50V

FESTOOL



RÉF. ART.	REFERENCE FABRICANT
EL102285	D50SVASD50V

TUYAU D36/32X3.5M AS/R

FESTOOL



RÉF. ART.	REFERENCE FABRICANT
EL102286	D36/32.3.5MAS/R

COMMANDE A DISTANCE CT-FI/M SET

FESTOOL



RÉF. ART.	REFERENCE FABRICANT
EL102287	CTFI/MSET

photos non contractuelles

FILTRE VC 20/40**HILTI**

ASPIRATEUR HILTI VC20 U (M) _ASPIRATEUR HILTI VC20 U Y (M)_ASPIRATEUR HILTI VC40 U (M)_ASPIRATEUR HILTI VC40 U Y (M)

RÉF. ART.	DESCRIPTION	REFERENCE FABRICANT
EL002096	FILTRE VC 20/40 HEPA	203879

FILTRE VC 20/40**HILTI**

ASPIRATEUR HILTI VC20 U (M) _ASPIRATEUR HILTI VC20 U Y (M)_ASPIRATEUR HILTI VC40 U (M)_ASPIRATEUR HILTI VC40 U Y (M)

RÉF. ART.	DESCRIPTION	REFERENCE FABRICANT
EL013302	SEC	2121386
EL013303	UNIVERSEL	2121387

FILTRE HEPA**HILTI**

RÉF. ART.	REFERENCE FABRICANT
EL920035	2240481

FILTRE TEFLON (SPECIAL POUSSIÈRES FINES)**HILTI**

ASPIRATEUR HILTI VC20 U (M) _ASPIRATEUR HILTI VC20 U Y (M)_ASPIRATEUR HILTI VC40 U (M)_ASPIRATEUR HILTI VC40 U Y (M)

RÉF. ART.	REFERENCE FABRICANT
EL002257	436058

FILTRE-POUSSIÈRE SET H

MAKITA



A logo with the text 'we life' and a red heart symbol above the 'i' in 'life'.

POUR ASPIRATEUR VC3211HX1 MAKITA

RÉF. ART.	DESCRIPTION
EL105890	- POUR ASPIRATEUR VC3211HX1 MAKITA

photos non contractuelles

**FILTRE POUSSIERE SET M POUR
ASPIRATEUR VC3211MX1**

MAKITA



ASPIRATEUR MAKITA VC3211 MX1 CLASSE M

RÉF. ART.
EL008543

**ENSEMBLE PREFILTRE POUR ASPIRATEUR
VC3211MX1**

MAKITA



RÉF. ART.
EL018625

**FILTRE MOUSSE POUR ASPIRATEUR
VC3211MX1**

MAKITA



RÉF. ART.
EL018626

SET 2 FILTRES AC 1600/30 PM

spit



ASPIRATEUR SPIT AC 1630 PM

RÉF. ART. REFERENCE FABRICANT
EL007710 644006

SAC A POUSSIERE FILTRANT POUR VC 20-UM-X

HILTI



PAR LOT DE 10

RÉF. ART.	REFERENCE FABRICANT
EL101080	2261258

SAC A POUSSIERES FILTRANT POUR VC 20-UM-Y LOT DE 5

HILTI



RÉF. ART.	DESCRIPTION	REFERENCE FABRICANT
EL004023	SAC A POUSSIERES FILTRANT POUR VC 20-UM LOT DE 5	203859

SAC A POUSSIERE FILTRANT POUR VC 40-UM-X

HILTI



PAR LOT DE 10

RÉF. ART.	REFERENCE FABRICANT
EL101083	2262130

SAC A POUSSIERES FILTRANT POUR VC 40-UM-Y LOT DE 5

HILTI



RÉF. ART.	DESCRIPTION	REFERENCE FABRICANT
EL004024	SAC A POUSSIERES FILTRANT POUR VC 40-UM LOT DE 5	203857

photos non contractuelles

SACS TISSU AVEC FERMETURE POUR ASPI. MAKITA VC3211MX1 et H

MAKITA



Lot de 5 sacs tissus avec fermeture pour aspirateur MAKITA "VC3211MX1" et "VC3211MHX1"

RÉF. ART.
EN008557

SAC ASPIRATEUR MICROFIBRE CLASSE M LOT DE 5 SACS

spit



ASPIRATEUR SPIT AC 1630 PM

RÉF. ART. REFERENCE FABRICANT
EL007648 620922

SAC JETABLE PE POUR ASPIRATEUR ASPIRATEUR CLASSE H EL105902

BOSCH



RÉF. ART.	DESCRIPTION	REFERENCE FABRICANT
EL111861	LOT DE 10	2607432051

FILTRE PLISSE PLAT POUR ASPIRATEUR BOSCH CLASSE H EL105902

BOSCH



RÉF. ART.	REFERENCE FABRICANT
EL111862	2607432052

photos non contractuelles

SAC FILTRANT DE SECURITE POUR ASPIRATEUR BOSCH CLASSE H EL105902

 **BOSCH**



RÉF. ART.	DESCRIPTION	REFERENCE FABRICANT
EL111863	LOT DE 5	2607432050

SAC FILTRE SELF CLEAN

FESTOOL



RÉF. ART.	DESCRIPTION	REFERENCE FABRICANT
EL102284	SC FI CT 36/5 LOT DE 5	SCFISCT36/5

ERGO'APP

PÔLE ERGO BYCN

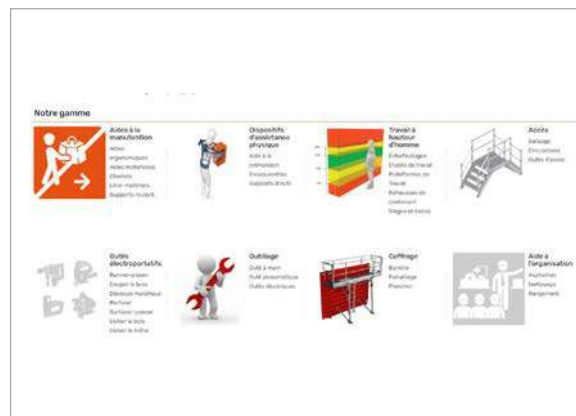

Outil d'aide à la décision permettant d'aider les collaborateurs à choisir les meilleurs outils, matériels ou matériaux selon un besoin et un contexte. Pour chaque produit, l'app propose une carte d'identité détaillée (caractéristiques techniques, photos, liens utiles) et précise pour quel type de tâches il est destiné. Evaluation sur la base de 5 critères : Amélioration de la sécurité, Apport sur la santé, Gain de productivité Intuitivité Poids < 15 kg

RÉF. ART.	DESCRIPTION
ERGO'APP	https://ergoapp.bouygues-construction.com/?lang=fr

photos non contractuelles

BOULONNEUSE SIW 22T

HILTI



we
life
b
DISTRIPUS

Clé à chocs sans fil dynamométrique de classe 22 V à couple élevé avec embout de détente à billes de 1/2" et embase robuste pour applications exigeantes dans les métiers de l'acier, du métal et du bois

RÉF. ART.	DESCRIPTION	REFERENCE FABRICANT
EL010810	-A 1/2 B 22/5.2 (2) + C 4/36-ACS	3594497

VERIFIEZ LA DISPONIBILITE DE NOS PRODUITS

DISTRIMO



En scannant le QR code, vérifiez le stock des produits à l'aide des références et de la barre de recherche

RÉF. ART.	DESCRIPTION
SITE WEB	http://distrimo.bouygues-construction.com/

Kit SIW 9 pour utilisation sur B20 carré 3/4

HILTI



we
life
b
DISTRIPUS

Pour utilisation sur B20

RÉF. ART.	DESCRIPTION	REFERENCE FABRICANT
EL104769	Kit SIW 9 Coffret + 2 B2/8.0 + C4/36-350	3705689

photos non contractuelles

BLOC ACCU B

HILTI



RÉF. ART.	DESCRIPTION	REFERENCE FABRICANT
EL020456	22/3.0 LI-ION	2136423
EL020457	22/5.2 LI-ION	2136396
EL920008	22/8.0 LI-ION	2183183

SET DE 2 BATTERIES FEIN



RÉF. ART.	DESCRIPTION
EL020218	SET DE 2 BATTERIES 2,5AH + CHARGEUR FEIN
EL020347	SET DE 2 BATTERIES 6 AH et CHARGEUR FEIN

ADAPTATEUR DE DOUILLE SI-S EXT 1/2 CARRE, CARRE 2

HILTI



BOULONNEUSE HILTI SIW 14-A_BOULONNEUSE HILTI SIW 22-A_BOULONNEUSE HILTI SIW 22T-A
Accessoires de prise d'impact pour les douilles de montage sur les clés à chocs avec différentes tailles de tige, angles ou longueurs

RÉF. ART.	LONGUEUR	REFERENCE FABRICANT
EL010386	L 51 MM	2076827

ADAPTATEUR DE DOUILLE SI-S EXT 1/2 CARRE, CARRE 5

HILTI



BOULONNEUSE HILTI SIW 14-A_BOULONNEUSE HILTI SIW 22-A_BOULONNEUSE HILTI SIW 22T-A
Accessoires de prise d'impact pour les douilles de montage sur les clés à chocs avec différentes tailles de tige, angles ou longueurs

RÉF. ART.	LONGUEUR	REFERENCE FABRICANT
EL009219	L 127 MM	2076828

photos non contractuelles

ADAPTATEUR DE DOUILLE SI-S EXT 1/2 CARRE

HILTI



BOULONNEUSE HILTI SIW 14-A_BOULONNEUSE HILTI SIW 22-A_BOULONNEUSE HILTI SIW 22T-A
Accessoires de prise d'impact pour les douilles de montage sur les clés à chocs avec différentes tailles de tige, angles ou longueurs

RÉF. ART.	LONGUEUR	REFERENCE FABRICANT
EL009990	L 254 MM	2076829

SIGNIFICATION DISTRIPLUS & WE LOVE LIFE



RÉF. ART.
PICTOS

TRANSPORT EXPRESS

LE SERVICE TRANSPORT EXPRESS SUR MESURE VOUS ASSURE L'ENLÈVEMENT ET LA LIVRAISON DE COLIS, PLANS, PALETTES ET HORS-GABARIT DANS LES DÉLAIS LES PLUS COURTS.



RÉF. ART.	DESCRIPTION
Transport express	L.BONAVENTURE@bouygues-construction.com j.imboden@bouygues-construction.com

photos non contractuelles

DOUILLE À CHOCS CARRÉ DE 3/4" EN 38 MM

ATEC



GOUPILLES ET JOINTS INCLUS

RÉF. ART.	DESCRIPTION
EL104750	- pour B20

DOUILLE À CHOCS LONGUE - IMPACT - 3/4" - 38 MM

ATEC



GOUPILLES ET JOINTS INCLUS

RÉF. ART.	DESCRIPTION
EL104751	- pour B20

DOUILLE IMPACT 6 PANS 3/4" EN 36 MM

ATEC



GOUPILLES ET JOINTS INCLUS

RÉF. ART.
EL104748

DOUILLE IMPACT 6 PANS LONGUE 36 MM X CARRÉ CONDUCTEUR 3/4"

ATEC



GOUPILLES ET JOINTS INCLUS

RÉF. ART.
EL104749

photos non contractuelles

DOUILLE A COUPLE CONTROLE

HILTI



BOULONNEUSE HILTI SIW 22T-A
Outil de pose pour goujon

RÉF. ART.	DESCRIPTION	LONGUEUR	DIAMETRE	REFERENCE FABRI- CANT
EL004125	S-TB HSA M10	L 10 MM	D 10 MM	423775

DOUILLE IMPACT SI-S1/2 LONGUE

HILTI



BOULONNEUSE HILTI SIW 14-A_BOULONNEUSE HILTI SIW
22-A_BOULONNEUSE HILTI SIW 22T-A
Douilles impact 1/2" longues

RÉF. ART.	LONGUEUR	DIAMETRE	REFERENCE FABRICANT
EL010378	L 80 MM	D 08 MM	2070385
EL009654	L 80 MM	D 10 MM	2070387
EL009448	L 80 MM	D 12 MM	2070388
EL009334	L 80 MM	D 15 MM	2070390
EL010236	L 80 MM	D 16 MM	2070391
EL010237	L 80 MM	D 18 MM	2070393
EL009814	L 80 MM	D 19 MM	2070394
EL009445	L 80 MM	D 21 MM	2070395
EL010379	L 80 MM	D 22 MM	2070396
EL009799	L 80 MM	D 24 MM	2070397
EL010161	L 80 MM	D 27 MM	2070398

DOUILLE IMPACT SI-S1/2 COURTE

HILTI



BOULONNEUSE HILTI SIW 14-A_BOULONNEUSE HILTI SIW
22-A_BOULONNEUSE HILTI SIW 22T-A
Douilles impact 1/2" courtes

RÉF. ART.	LONGUEUR	DIAMETRE	REFERENCE FABRICANT
EL009201	L 40 MM	D 08 MM	2070367
EL009162	L 40 MM	D 10 MM	2070369
EL009447	L 40 MM	D 12 MM	2070370
EL009333	L 40 MM	D 13 MM	2070371
EL009070	L 40 MM	D 15 MM	2070372
EL010002	L 40 MM	D 16 MM	2070373
EL009670	L 40 MM	D 17 MM	2070374
EL009671	L 40 MM	D 19 MM	2070376
EL009672	L 40 MM	D 24 MM	2070379

DOUILLE IMPACT SI-S1/2 PROFONDE

HILTI



BOULONNEUSE HILTI SIW 14-A_BOULONNEUSE HILTI SIW
22-A_BOULONNEUSE HILTI SIW 22T-A
2070402

RÉF. ART.	LONGUEUR	DIAMETRE	REFERENCE FABRICANT
EL012704	L 100 MM	D 13 MM	2070402
EL012705	L 100 MM	D 15 MM	2070403

photos non contractuelles

DOUILLE IMPACT SI-S 3/4 COURTE

HILTI



BOULONNEUSE HILTI SIW 14-A_BOULONNEUSE HILTI SIW 22-A_BOULONNEUSE HILTI SIW 22T-A
 Douille de 3/4" (pouce) courte pour le serrage des boulons et des ancrés

RÉF. ART.	LONGUEUR	DIAMETRE	REFERENCE FABRICANT
EL012707	L 48 MM	D 19 MM	2070409
EL012708	L 48 MM	D 21 MM	2072890
EL012709	L 48 MM	D 24 MM	2070410
EL012710	L 51 MM	D 27 MM	2070411
EL012711	L 52 MM	D 30 MM	2070412
EL008904	L 56 MM	D 36 MM	2070413
EL012712	L 58 MM	D 41 MM	2070414
EL009984	L 63 MM	D 46 MM	2070415
EL010925	L 80 MM	D 60 MM	2070418

ADAPTATEUR DE DOUILLE IMPACT SI-SA 1/2

HILTI



BOULONNEUSE HILTI SIW 14-A_BOULONNEUSE HILTI SIW 22-A_BOULONNEUSE HILTI SIW 22T-A
 Accessoires de prise d'impact pour les douilles de montage sur les clés à chocs avec différentes tailles de tige, angles ou longueurs

RÉF. ART.	DESCRIPTION	LONGUEUR	REFERENCE FABRICANT
EL009594	Mandrin pour embout 7/16"	L 50 MM	2094451

AUGMENTATEUR DOUILLE IMPACT SI-SA 1/2

HILTI



BOULONNEUSE HILTI SIW 14-A_BOULONNEUSE HILTI SIW 22-A_BOULONNEUSE HILTI SIW 22T-A
 Accessoires de prise d'impact pour les douilles de montage sur les clés à chocs avec différentes tailles de tige, angles ou longueurs

RÉF. ART.	DESCRIPTION	LONGUEUR	REFERENCE FABRICANT
EL008903	Extrémité de connexion: 1/2" carré, 3/4" carré	L 50 MM	2077172

AUGMENTATEUR DOUILLE IMPACT SI-SA 1/4

HILTI



BOULONNEUSE HILTI SIW 14-A_BOULONNEUSE HILTI SIW 22-A_BOULONNEUSE HILTI SIW 22T-A
 Accessoires de prise d'impact pour les douilles de montage sur les clés à chocs avec différentes tailles de tige, angles ou longueurs

RÉF. ART.	DESCRIPTION	LONGUEUR	REFERENCE FABRICANT
EL010265	Extrémité de connexion: Mandrin pour embout 1/4" hexagonal, 1/2" carré	L 60 MM	2077174

photos non contractuelles

REDUCTEUR DOUILLE IMPACT SI-SA 3/4 à 1/2

HILTI



BOULONNEUSE HILTI SIW 14-A_BOULONNEUSE HILTI SIW 22-A_BOULONNEUSE HILTI SIW 22T-A

Accessoires de prise d'impact pour les douilles de montage sur les clés à chocs avec différentes tailles de tige, angles ou longueurs

RÉF. ART.	DESCRIPTION	LONGUEUR	REFERENCE FABRICANT
EL009193	DOUILLE IMPACT SI-SA -3/4-1/2° SQ	L 56 MM	2094452

DOUILLE IMPACT S-NSD 1/2 COURTE

HILTI



BOULONNEUSE HILTI SIW 14-A_BOULONNEUSE HILTI SIW 22-A_BOULONNEUSE HILTI SIW 22T-A

Douille pour visseuse à choc

RÉF. ART.	DESCRIPTION	LONGUEUR	DIAMETRE	REFERENCE FABRICANT
EL008594	DOUILLE IMPACT S-NSD 1/2 21 S	L 40 MM	D 21 MM	2070377
EL010377	DOUILLE IMPACT S-NSD 1/2 22 S	L 40 MM	D 22 MM	2070378

DOUILLE IMPACT S-NSD 1/2

HILTI



BOULONNEUSE HILTI SIW 14-A_BOULONNEUSE HILTI SIW 22-A_BOULONNEUSE HILTI SIW 22T-A
Douille pour visseuse à choc

RÉF. ART.	DESCRIPTION	LONGUEUR	DIAMETRE	REFERENCE FABRICANT
EL010259	27	L 40 MM	D 27 MM	2070380
EL008541	30 (Remplace H408412)	L 40 MM	D 30 MM	2070381
EL008540	30 (Remplace H408426)	L 80 MM	D 30 MM	2070399
EL001929	L 17L	L 80 MM	D 17 MM	2070392
EL001931	S D. 18	L 40 MM	D 18 MM	2070375

DOUILLE IMPACT S-NSD

HILTI



VISSEUSE HILTI SF 14-A _VISSEUSE HILTI SFC 14-A _VISSEUSE HILTI SF 22-A _VISSEUSE SPIT HDI 286
Ensemble de douilles à choc 1/2"

RÉF. ART.	DESCRIPTION	LONGUEUR	REFERENCE FABRICANT
EL012717	13-15 JEU		408429
EL001934	13-24 EU BOITE DE 9	L 78 MM	408428

photos non contractuelles

DOUILLE IMPACT SOCKET SI-S 1/2

HILTI



BOULONNEUSE HILTI SIW 14-A_BOULONNEUSE HILTI SIW 22-A_BOULONNEUSE HILTI SIW 22T-A
 Douille pour visseuse à choc

RÉF. ART.	DESCRIPTION	LONGUEUR	DIAMETRE	REFERENCE FABRI-CANT
EL009065	- 13 L	L 80 MM	D 13 MM	2070389

DOUILLE MAGNETIQUE S-NSD 21 1/2

HILTI



BOULONNEUSE HILTI SIW 14-A_BOULONNEUSE HILTI SIW 22-A
 En complément de la boulonneuse SI 100 - Douille magnétique

RÉF. ART.	DESCRIPTION	LONGUEUR	DIAMETRE	REFERENCE FABRI-CANT
EL008595	M HUS-H 16.5	L 100 MM	D 21 MM	2077176

DOUILLE S-NS

HILTI

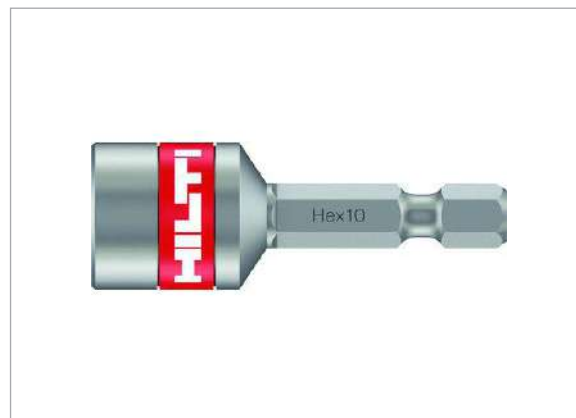

CLE A CHOC SID 14-A_CLE A CHOC SID 22-A_AUTRE VIS-SEUSE HILTI
 Douille magnétique

RÉF. ART.	DESCRIPTION	LONGUEUR	DIAMETRE	REFERENCE FABRI-CANT
EL009787	10M 50/2	L 50 MM	D 10 MM	2039227
EL012718	12 M 50/2	L 50 MM	D 12 MM	2039228
EL019764	13 C 95/3 3/4""			2149244
EL012719	13 M 50/2			2039229
EL012721	3/8 C 50/2			2039250
EL009124	7M 50/2	L 50 MM	D 07 MM	2039225
EL009180	8M 50/2	L 50 MM	D 08 MM	2039226

DOUILLE S-NSS UNI

HILTI



CLE A CHOC SID 14-A_CLE A CHOC SID 22-A_AUTRE VIS-SEUSE HILTI
 Douille magnétique

RÉF. ART.	DESCRIPTION	LONGUEUR	REFERENCE FABRICANT
EL012723	C 50/2"" (8" KIT	L 50 MM	2039256
EL009104	M 50/2	L 50 MM	2039240

photos non contractuelles

DOUILLE S-NSS UNI C 50/2"

HILTI

VISSEUSE HILTI SF 14-A _VISSEUSE HILTI SFC 14-A _VISSEUSE
HILTI SF 22-A _VISSEUSE SPIT HDI 286
H2039263 - Pièce de raccordement

RÉF. ART.	DESCRIPTION	REFERENCE FABRICANT
CO003483	PIECE DE RACCORDEMENT S-AT 3/8-1/4 50/	2039263

PORTE EMBOUT S-BH 75 1/2 1/4

HILTI

BOULONNEUSE HILTI SIW 22-A
Porte-trépied pour tournevis, conversion de la clé à chocs

RÉF. ART.	REFERENCE FABRICANT
EL010381	369097

PORTE EMBOUT S-BH 1/2 1/4

HILTI

BOULONNEUSE HILTI SIW 22-A
Porte embout - 1 - 2

RÉF. ART.	DESCRIPTION	LONGUEUR	REFERENCE FABRICANT
EL008620	(Remplace H369096)	L 38 MM	2077170

S-TB HSA

HILTI

BOULONNEUSE HILTI SIW 22T-A
Outil de pose pour goujon

RÉF. ART.	DESCRIPTION	LONGUEUR	DIAMETRE	REFERENCE FABRICANT
EL004126	M12	L 12 MM	D 12 MM	423776
EL004127	M16	L 16 MM	D 16 MM	423777
EL004128	M8 -423774	L 08 MM	D 08 MM	423774

CAROTTEUSE AU DIAMANT DD 30-W

HILTI



we
life
b
DISTRIPUS

Perceuse compacte de diamant léger pour carottage à main d'ancrage et trous de barres d'armature robustes dans des diamètres allant jusqu'à 35 mm / remplace EL017972

RÉF. ART.	DESCRIPTION	PUISSANCE	REFERENCE FABRICANT
EL017998	230V	P 1450 W	2043845

CAROTTEUSE AU DIAMANT DD 250 BL

HILTI



SUR COMMANDE
we
life
b
DISTRIPUS

Système de forage au diamant robuste pour le carottage de forage dans une large gamme de diamètres de 12-450 mm

RÉF. ART.	DESCRIPTION	PUISSANCE	REFERENCE FABRICANT
EL011381	CAROTTEUSE AU DIAMANT DD 250 230V BL	P 3200 W	2105319

CAROTTEUSE AU DIAMANT DD 150-U (BL)

HILTI



we
life
b
DISTRIPUS

remplace EL010242

RÉF. ART.	DESCRIPTION	PUISSANCE	REFERENCE FABRICANT
EL100088	CAROTTEUSE AU DIAMANT DD 150-U 230V	P 2200 W	2204025

CARROTEUSE AU DIAMANT DD 350-CA BL

HILTI



we
life
b
DISTRIPUS

Carroteuse diamant avec système d'assistance de coupe DD 350-CA BL // Produit sur commande soumis à délai fournisseur (>72h)

RÉF. ART.	DESCRIPTION	PUISSANCE	REFERENCE FABRICANT
EL009209	230V	P 3600 W	2087381

photos non contractuelles

MONTANT DE PERCEUSE DD

HILTI



CAROTTEUSE HILTI DD 30 W
MONTANT DE PERCEUSE DD-ST 30

RÉF. ART.	DESCRIPTION	REFERENCE FABRICANT
EL018105	-ST 30 (VENDU A L'UNITÉ)	2051335
EL020294	-ST 150-U	2203155
EL017357	-HD 30	2148548

ADAPTATEUR BS/BI

HILTI



AUTRE CARROTEUSE HILTI_CAROTTEUSE HILTI DD 150_
CAROTTEUSE HILTI DD 200 _CAROTTEUSE HILTI DD 250_
CAROTTEUSE HILTI DD 350
Adaptateurs pour couronne de forage diamant

RÉF. ART.	REFERENCE FABRICANT
EL000029	373422

ADAPTATEUR BL/BU

HILTI



AUTRE CARROTEUSE HILTI_CAROTTEUSE HILTI DD 150_
CAROTTEUSE HILTI DD 200 _CAROTTEUSE HILTI DD 250_
CAROTTEUSE HILTI DD 350
Adaptateurs pour couronne de forage diamant

RÉF. ART.	REFERENCE FABRICANT
EL000026	282989

ADAPTATEUR DD-

HILTI



AUTRE CARROTEUSE HILTI_CAROTTEUSE HILTI DD 150_
CAROTTEUSE HILTI DD 200 _CAROTTEUSE HILTI DD 250_
CAROTTEUSE HILTI DD 350

RÉF. ART.	DESCRIPTION	REFERENCE FABRICANT
EL010934	ST HCLA-150/160	2048483

photos non contractuelles

BAGUE COLLECTEUR D'EAU

HILTI



AUTRE CARROTEUSE HILTI_CAROTTEUSE HILTI DD 150_
CAROTTEUSE HILTI DD 200 _CAROTTEUSE HILTI DD 350

RÉF. ART.	DESCRIPTION	REFERENCE FABRICANT
EL000183	DD-WC-ML	232243
EL000185	DD-WC-SM	232221

BROCHE D'ENTRAÎNEMENT

HILTI



AUTRE CARROTEUSE HILTI_CAROTTEUSE HILTI DD 150_
CAROTTEUSE HILTI DD 200 _CAROTTEUSE HILTI DD 250_
CAROTTEUSE HILTI DD 350

X

RÉF. ART.	DESCRIPTION	REFERENCE FABRICANT
EL000306	TE-DD-AS 6KT	6734

BROCHE DE SERRAGE

HILTI



CAROTTEUSE HILTI DD 150
Pour la fixation par chevillage des semelles

RÉF. ART.	DESCRIPTION	REFERENCE FABRICANT
EL000302	DD-CS M12S-SM	251830
EL000303	DD-CS M16	337378
EL000305	EXT. DD-HD30-SL	305940

CAPOT DE PROTECTION

HILTI



CAROTTEUSE HILTI DD 30

RÉF. ART.	DESCRIPTION	REFERENCE FABRICANT
EL017992	DD-30-W-CV	2046235

photos non contractuelles

DEBIMETRE DD

HILTI



AUTRE CAROTTEUSE HILTI_CAROTTEUSE HILTI DD 150_
 CAROTTEUSE HILTI DD 200 _CAROTTEUSE HILTI DD 250_
 CAROTTEUSE HILTI DD 350
 Réservoir d'eau pour le refroidissement lors de l'utilisation d'un système de carottage diamant

RÉF. ART.	DESCRIPTION	REFERENCE FABRICANT
EL001789	-WFI	305939

ECROU A SERRAGE RAPIDE

HILTI



AUTRE CAROTTEUSE HILTI_CAROTTEUSE HILTI DD 150_
 CAROTTEUSE HILTI DD 200 _CAROTTEUSE HILTI DD 250_
 CAROTTEUSE HILTI DD 350
 Pour la fixation par chevillage des semelles

RÉF. ART.	DESCRIPTION	REFERENCE FABRICANT
EL002032	DD-CN-SML	251834

EMMANCHEMENT

HILTI



RÉF. ART.	DESCRIPTION	REFERENCE FABRICANT
EL002145	BI-1	236120
EL002146	BR-1	236121
EL002149	DD-BS 52-600	286794

EXTENSION RAIL GUIDAGE

HILTI



RÉF. ART.	DESCRIPTION	REFERENCE FABRICANT
CO002223	0.3ML DD-HD30-XT30	285296

photos non contractuelles

JAUGE DE PROFONDEUR DD

HILTI

CAROTTEUSE HILTI DD 30

RÉF. ART.	DESCRIPTION	REFERENCE FABRICANT
EL018052	-ST30-ES	2046234

RECYCLEUR POUR CAROTTEUSE KIT DD-WMS

HILTI

RÉF. ART.	DESCRIPTION	REFERENCE FABRICANT
EL100502	KIT DD-WMS 100 EQUIPE (VENDU A L'UNITÉ)	3654438

JOINT DD-WCS

HILTI

RÉF. ART.	DESCRIPTION	REFERENCE FABRICANT
EL018054	-122 JEU	2166107
EL018055	-142 JEU	2166108
EL018056	-172 JEU	2166109
EL018057	-250 JEU	2166200
EL018058	-30 CAOUTCHOUC	2046237
EL018059	-67 JEU	2166106

SAC FILTRANT POUR RECYCLEUR

HILTI

AUTRE CARROTEUSE HILTI_CAROTTEUSE HILTI DD 150_
CAROTTEUSE HILTI DD 200 _CAROTTEUSE HILTI DD 250_
CAROTTEUSE HILTI DD 350

Sacs filtrants pour l'unité de gestion de l'eau WMS 100 pour l'alimentation en eau de refroidissement plus collecte et filtration des eaux usées des systèmes de forage au diamant

RÉF. ART.	DESCRIPTION	REFERENCE FABRICANT
EL017225	SAC FILTRANT DD WMS 100 MP 25 LOT DE 25	2145834
EL017312	SAC FILTRANT DD-WMS 100 GRAND LOT DE 5	2145833

photos non contractuelles

KIT DE RECUPERATION D'EAU DD-

HILTI



AUTRE CARROTEUSE HILTI_CAROTTEUSE HILTI DD 200
_CAROTTEUSE HILTI DD 350

RÉF. ART.	DESCRIPTION	REFERENCE FABRICANT
EL002500	KIT DE RECUPERATIO D'EAU DD-BL	2040916
EL002513	KIT RECUPERATUIN D EAU DD-BI	2040915

MODULE LASER DD-

HILTI



AUTRE CARROTEUSE HILTI_CAROTTEUSE HILTI DD 150_
CAROTTEUSE HILTI DD 200 _CAROTTEUSE HILTI DD 350

RÉF. ART.	DESCRIPTION	REFERENCE FABRICANT
EL014334	ST HCL	2048481

MECHE DE CENTRAGE

HILTI



AUTRE CARROTEUSE HILTI_CAROTTEUSE HILTI DD 150_
CAROTTEUSE HILTI DD 200 _CAROTTEUSE HILTI DD 250_
CAROTTEUSE HILTI DD 350

Remplacement pour corps de couronne pour TE-C-DS

RÉF. ART.	DESCRIPTION	REFERENCE FABRICANT
EL002938	DS-ZB 130	339134

PLAQUE DE REAFFUTAGE

HILTI



AUTRE CARROTEUSE HILTI_CAROTTEUSE HILTI DD 150_
CAROTTEUSE HILTI DD 200 _CAROTTEUSE HILTI DD 250_
CAROTTEUSE HILTI DD 350

Pour réaffuter tout type de couronnes

RÉF. ART.	DESCRIPTION	REFERENCE FABRICANT
EL003588		51343
EL003589	DC-SE SP2	314303

POMPE A VIDE

HILTI



AUTRE CARROTEUSE HILTI_CAROTTEUSE HILTI DD 150_
CAROTTEUSE HILTI DD 200 _CAROTTEUSE HILTI DD 350

RÉF. ART.	DESCRIPTION	REFERENCE FABRICANT
EL003684	DD VP-U 230V	408458

RACCORD ASPIRATEUR DD

HILTI



AUTRE CARROTEUSE HILTI_CAROTTEUSE HILTI DD 150_
CAROTTEUSE HILTI DD 200 _CAROTTEUSE HILTI DD 350

RÉF. ART.	DESCRIPTION	REFERENCE FABRICANT
EL003761	-WDA 44166	213149

POMPE DSH

HILTI



RÉF. ART.	DESCRIPTION	REFERENCE FABRICANT
EL018746	-P	2124505

RESERVOIR D'ALIMENTATION D'EAU

HILTI



AUTRE CARROTEUSE HILTI_CAROTTEUSE HILTI DD 150_
CAROTTEUSE HILTI DD 200 _CAROTTEUSE HILTI DD 350
Réservoir d'eau pour le refroidissement lors de l'utilisation d'un
système de carottage diamant

RÉF. ART.	DESCRIPTION	REFERENCE FABRICANT
EL003893	DWP 10	365595

photos non contractuelles

RONDELLE ETANCHEITE

HILTI



AUTRE CARROTEUSE HILTI_CAROTTEUSE HILTI DD 150_
 CAROTTEUSE HILTI DD 200 _CAROTTEUSE HILTI DD 250_
 CAROTTEUSE HILTI DD 350
 Le chantier reste propre grâce à la collecte d'eau s'effectuant à la base des couronnes diamant lors du forage - compatible avec le recycleur d'eau DD-WMS 100

RÉF. ART.	DESCRIPTION	DIAMETRE	REFERENCE FABRICANT
CO009763	DD-SW-250-L	D 250 MM	207342

SET D'ACCESSOIRES

HILTI



CAROTTEUSE HILTI DD 150

RÉF. ART.	DESCRIPTION	REFERENCE FABRICANT
EL004106	DD M12 L	409279
EL009727	DD M12 S	409269
EL009460	DD M16	409303

SEMELLE VENTOUSE

HILTI



AUTRE CARROTEUSE HILTI_CAROTTEUSE HILTI DD 200_
 _CAROTTEUSE HILTI DD 350
 Ventosables ou chevillables

RÉF. ART.	DESCRIPTION	REFERENCE FABRICANT
EL004084	DD-HD30-VBP	305538

SYSTEME DE RECUPERATION D'EAU

HILTI



AUTRE CARROTEUSE HILTI_CAROTTEUSE HILTI DD 150

RÉF. ART.	DESCRIPTION	REFERENCE FABRICANT
EL017322	DD-WCS-122	2159811
EL017324	DD-WCS-172	2159813

UNITE D'AVANCE AUTO

HILTI

AUTRE CARROTEUSE HILTI_CAROTTEUSE HILTI DD 350
Système d'assistance de coupe pour carroteuse DD 350

RÉF. ART.	DESCRIPTION	PUISSANCE	REFERENCE FABRICANT
EL009208	DD AF-CA 220-480V	P 100 W	2082528

VOLANT A MAIN

HILTI

RÉF. ART.	DESCRIPTION	REFERENCE FABRICANT
EL009459	DD-HW-3A	2007687

photos non contractuelles

FUT (PREVOIR X RING)



RÉF. ART.	DESCRIPTION
EL019---	DIAMETRE ET CARACTERISTIQUES A DEFINIR avec votre interlocuteur Distrimo

COURONNE DE FORAGE



RÉF. ART.	DESCRIPTION
EL019--1	DIAMETRE ET CARACTERISTIQUES A DEFINIR avec votre interlocuteur Distrimo

X-RING POUR FUT



RÉF. ART.	DESCRIPTION
EL017---	DIAMETRE ET CARACTERISTIQUES A DEFINIR avec votre interlocuteur Distrimo

Merci de contacter Distrimo ou Hilti pour toute demande de consommables carottage



RÉF. ART.	DESCRIPTION
EL01----	Vous rapprocher de votre interlocuteur Distrimo

CERCLEUSE POUR FEUILLARD PVC

FROMM

we
life

Batterie 18V – Dimensions du feuillard : larg. 8.0 à 13mm / épais. 0.35 à 0.8mm – 3,4kg – Prévoir dérouleur EL020182 et feuillard EL020183

RÉF. ART.	DESCRIPTION
EL020181	FROMM 18V

FEUILLARD POUR DÉROULEUR

FROMM

we
life

Feuillard plastique, bande de 12.5 X 0.80 – 1750m

RÉF. ART.
EL020183

DÉROULEUR POUR FEUILLARD PLASTIQUE

FROMM

we
life

RÉF. ART.
EL020182

photos non contractuelles

CISAILLE FEIN ABSS 18V 1.6 E SELECT NUE FEIN



Prévoir batteries et chargeur

RÉF. ART.
EL104716

CISAILLE HYDRAULIQUE EBS-12 AVEC 1 BATTERIE ET CHARGEUR

KLAUKE



COUPE FER JUSQU'À DIA 10MM

RÉF. ART.
EL008315

COUPE CÂBLES BATTERIE KLAUKE ES 65-L

KLAUKE



Batterie 18V – Coupe maximum Ø 65 mm – 6,3kg

RÉF. ART.
EL017138

COUPE TIGES FILETEES DSC102ZJ

MAKITA



RÉF. ART.	DESCRIPTION	REFERENCE FABRICANT
EL106969	(TIGES ACIER M6/M8/M10 - TIGES INOX M6/M8)	DSC102ZJ

BATTERIE DE RECHANGE POUR CISAILLE EBS KLAUKE

KLAUKE



CISAILLE ATDV EBS-12

RÉF. ART.	DESCRIPTION
EL100660	10,8V 1,5AH
EL008313	12 9,6V 1,3AH

COUTEAUX DE RECHANGE POUR CISAILLE EBS-12 KLAUKE

KLAUKE



CISAILLE ATDV EBS-12

RÉF. ART.	DESCRIPTION
EL100661	JEU DE 2

CHARGEUR DE BATTERIE DE RECHANGE POUR CISAILLE EBS-12 KLAUKE

KLAUKE



CISAILLE ATDV EBS-12

RÉF. ART.
EL008314

COUTEAUX DE RECHANGE POUR CISAILLE ESB

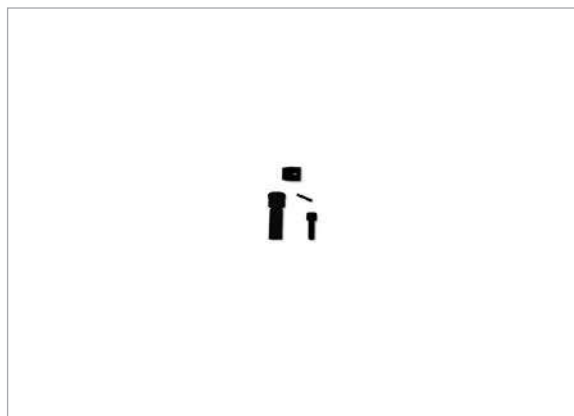
CISAILLE ATDV EBS-12
pour cisaille de marque ATDV

RÉF. ART.	DESCRIPTION
EL008312	-12 JEU DE 2 - ATDV

photos non contractuelles

LAME CENTRALE POUR CISSAILLE JS1660

MAKITA



CISSAILLE MAKITA DJS161RMJ_CISSAILLE MAKITA JS1601
LAME CENTRALE POUR CISSAILLE JS1660

RÉF. ART.	REFERENCE FABRICANT
EL010453	792534-4

COUTEAUX DE RECHANGE POUR CISSAILLE JS1601

MAKITA



CISSAILLE MAKITA DJS161RMJ_CISSAILLE MAKITA JS1601

RÉF. ART.	REFERENCE FABRICANT
EL008311	792533-6

photos non contractuelles

CLOUEUR GAZ PULSA 800 E + 3500 HC6-17

spit



Cloueur à gaz multi-matériaux spécial électriciens/plombiers

RÉF. ART.	PUISSANCE	REFERENCE FABRICANT
EL010748	Pu 82 J	12552

CLOUEUR GAZ SABOT F40/65 G1

ALSAFIX



Spéciale filière bois - Cloueur gaz sabot F40/65 G1 pour clous de 35 à 50MM avec chargeur et 2 batteries

RÉF. ART.	DESCRIPTION
EL018194	POUR CLOUS DE 35 À 50MM

AUTRES CLOUEURS

HILTI

RÉF. ART.	DESCRIPTION	REFERENCE FABRICANT
EL019--2	Vous rapprocher de votre interlocuteur Distrimo	2163828

SIGNIFICATION DISTRIPLUS & WE LOVE LIFE



RÉF. ART.

PICTOS

SUR COMMANDE = soumis à des délais supérieurs à ceux habituels

SUR COMMANDE = SOUMIS À DES DÉLAIS SUPÉRIEURS À CEUX HABITUELS



RÉF. ART.

SUR COMMANDE

photos non contractuelles

Accessoires clouage

HILTI



RÉF. ART.	DESCRIPTION	REFERENCE FABRICANT
EL	Vous rapprocher de votre interlocuteur Distrimo	39535

CONSOMMABLES CLOUAGE

HILTI

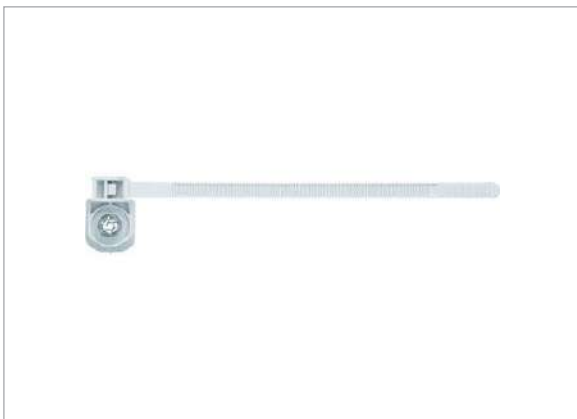

RÉF. ART.	DESCRIPTION	EPAIS-SEUR	REFERENCE FABRICANT
CO01---	Vous rapprocher de votre interlocuteur Distrimo	H 12 MM	432947

photos non contractuelles

DECOUPEUR POWERMAX 30 AIR - COMPRESSEUR INTEGRE

HYPERTHERM



RÉF. ART.	DESCRIPTION
EL101361	, pièces détachées ci-dessous
EL101517	VALISE DE TRANSPORT POUR POWERMAX 30 AIR
EL101518	ELECTRODE T30 AIR
EL101519	TUYERE T30 AIR
EL101520	DIFFUSEUR AIR T30 AIR
EL101521	BUSE DE PROTECTION T30
EL101522	DEFLECTEUR DE PROTECTION

SCIE TANGA LAMELLO DX200 1700W

LAMELLO



1700W + BUTEE DE FEUILLURE **Nécessite un accord de la Prévention Santé Sécurité**

RÉF. ART.	DESCRIPTION
EL020687	

DECAPEUR THERMIQUE MAKITA HG5012K

MAKITA



[1600W - débit 350 à 500 l/min - T° air 350 à 500 °C - 0,68kg]

RÉF. ART.	DESCRIPTION
EL018713	

GRIGNOTEUSE FILAIRE FEIN BLK 1.6



RÉF. ART.	DESCRIPTION
EL113061	E jusqu'à 1,6mm

photos non contractuelles

CISAILLE FILAIRE UNIVERSELLE



RÉF. ART.	DESCRIPTION
EL113062	JUSQU'À 1,6 mm
EL113063	JUSQU'À 2 mm

KIT DE CONSOMMABLES PMX30 AIR

HYPERTHERM



RÉF. ART.	REFERENCE FABRICANT
EL104008	SPE000

DECOUPEUSE BATTERIE K535i XP

HUSQVARNA



RÉF. ART.	DESCRIPTION
EL113064	(livrée avec disque TACTI-CUT S35 Silence)

Batterie Li-Ion 24V 6AH pour GR20B



RÉF. ART.	REFERENCE FABRICANT
EL112042	G20B/51

Chargeur 220V pour GR20B



RÉF. ART.	REFERENCE FABRICANT
EL112043	G20B/52

SCIE À DIAMANT CC301DSAE

MAKITA



RÉF. ART.	DESCRIPTION	REFERENCE FABRICANT
EL112189	12 V CXT LI-ION 2 AH Ø85 MM MAKITA	CC301DSAE

photos non contractuelles

BATTERIE BLI 300

HUSQVARNA



RÉF. ART.

EL113065

CHARGEUR BATTERIE QC500

HUSQVARNA



RÉF. ART.

EL113066

DESCRIPTION

500W

CAISSE DE RANGEMENT BATTERIE ET CHARGEUR

HUSQVARNA



RÉF. ART.

EL113067

Disques carbure PremiumTCT110

RÉF. ART.

EL112044

DESCRIPTION

- Ø 110mm 24 dents

REFERENCE FABRICANT

TCT110/10

MATRICE POUR GRIGNOTEUSE DJN161RTJ

MAKITA

GRIGNOTEUSE MAKITA DJN161RMJ
MATRICE POUR GRIGNOTEUSE DJN161RTJ

RÉF. ART.

EL010454

REFERENCE FABRICANT

A-15051

photos non contractuelles

POINÇON HAUTE QUALITÉ POUR GRIGNOTEUSE DJN161RTJ

MAKITA



GRIGNOTEUSE MAKITA DJN161RMJ
POINÇON POUR GRIGNOTEUSE DJN161RTJ HAUTE QUALITE

RÉF. ART.	REFERENCE FABRICANT
EL010457	A-83951

TRANSPORT EXPRESS

LE SERVICE TRANSPORT EXPRESS SUR MESURE VOUS ASSURE L'ENLÈVEMENT ET LA LIVRAISON DE COLIS, PLANS, PALETTES ET HORS-GABARIT DANS LES DÉLAIS LES PLUS COURTS.



RÉF. ART.	DESCRIPTION
Transport express	L.BONAVENTURE@bouygues-construction.com j.imboden@bouygues-construction.com

Une idée de nouveau produit ?



RÉF. ART.	DESCRIPTION
NOUVEAU PRODUIT	mailto:t.bobin@bouygues-construction.com

VERIFIEZ LA DISPONIBILITE DE NOS PRODUITS

DISTRIMO



En scannant le QR code, vérifiez le stock des produits à l'aide des références et de la barre de recherche

RÉF. ART.	DESCRIPTION
SITE WEB	http://distrimo.bouygues-construction.com/

PISTOLET À MASTIC SUR BATTERIE 18V - MAKITA

MAKITA



Sur batterie - 18V / 1,5Ah / 5000N

RÉF. ART.

EL008687

PISTOLET CONVOY SUPER 26 DEMULTIPLICATEUR POUR SILICONE

TAJIMA



L'effort à exercer sur la poignée est démultipliée par 26 par rapport à un pistolet standard manuel. Stoppe le rejet de matériau dès action sur la gâchette.

RÉF. ART.

CO010517

PISTOLET MANUEL POUR CARTOUCHE

TAJIMA



RÉF. ART.

CO003562

DESCRIPTION

L.300ML

TUBE ALU PISTOLET MAKITA DCG180RY

MAKITA



PISTOLET ELECTRIQUE A SILICONE MAKITA

Pour pistolet DCG180RY - pour cartouche 600 ml et pot

RÉF. ART.

EL008688

DESCRIPTION

POUR CARTOUCHE 600ML

photos non contractuelles

LIGATUREUSE D'ARMATURES DF 16

WACKER NEUSON

we
life

remplace le EL020857

RÉF. ART.	DESCRIPTION
EL100080	, prévoir AGRAFES POUR LIGATUREUSE DF 16 EL100387

**PISTOLET A LIGATURER MAKITA SEUL
DTR180ZJ**

MAKITA

we
life
DISTRIPLUSVENDU NU EN COFFRET, prévoir batterie 18V et fil à ligaturer
MAKITA EL020715

RÉF. ART.
EL020714

**PISTOLET RB398 À LIGATURE DE DEUX
FERS****MAX**we
life
DISTRIPLUSCUMUL DES 2 FERS - AVEC 2 BATTERIES LI ION ET
CHARGEUR. Prévoir fil à ligaturer EL005788

RÉF. ART.	DESCRIPTION
EL010018	D.20-39MM (CUMUL)

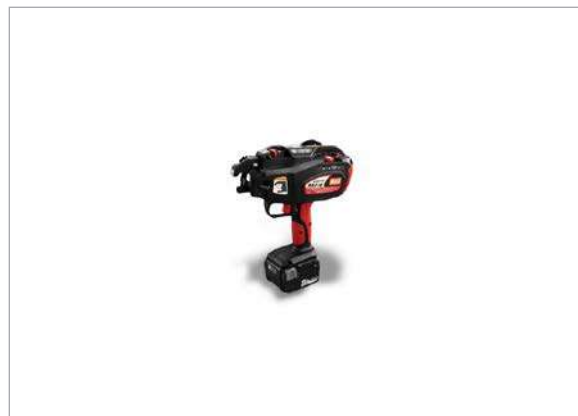
**PISTOLET RB218 À LIGATURE DE DEUX
FERS****MAX**we
life
DISTRIPLUSCUMUL DES 2 FERS - AVEC 2 BATTERIES LI ION ET CHARGEUR
Prévoir fil à ligaturer EL005788

RÉF. ART.	DESCRIPTION
EL009996	D.9-21MM (CUMUL)

photos non contractuelles

PISTOLET RB655 A LIGATURE FERS

MAX

PISTOLET RB655 A LIGATURE Ø20mm A Ø65mm AVEC 2 ACCUS ET CHARGEUR - Idéal pour ligaturer les gaines de plancher avant coulage. Prévoir fil à ligaturer EL008941

RÉF. ART.	DESCRIPTION
EL008940	Ø 20 A 65 (CUMUL)

ERGO'APP

PÔLE ERGO BYCN

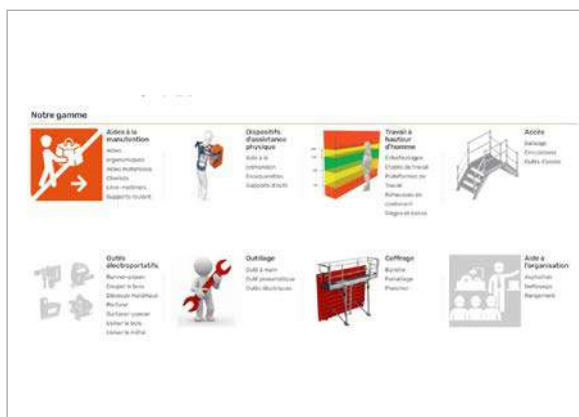

Outil d'aide à la décision permettant d'aider les collaborateurs à choisir les meilleurs outils, matériels ou matériaux selon un besoin et un contexte. Pour chaque produit, l'app propose une carte d'identité détaillée (caractéristiques techniques, photos, liens utiles) et précise pour quel type de tâches il est destiné. Evaluation sur la base de 5 critères : Amélioration de la sécurité, Apport sur la santé, Gain de productivité Intuitivité Poids < 15 kg

RÉF. ART.	DESCRIPTION
ERGO'APP	https://ergoapp.bouygues-construction.com/?lang=fr

photos non contractuelles

CHARGEUR POUR PISTOLET MAX RB397**MAX**

PISTOLET A LIGATURER MAX RB 218_PISTOLET A LIGATURER
MAX RB 398

RÉF. ART.	DESCRIPTION
EL009091	230V

RALLONGE PISTOLET A LIGATURER

MAFELL



PISTOLET A LIGATURER MAX RB 218_PISTOLET A LIGATURER
MAX RB 398
POUR TRAVAIL AU SOL DEBOUT

RÉF. ART.	DESCRIPTION
EL003861	POUR TRAVAIL AU SOL DEBOUT

photos non contractuelles

CARTON DE 7700 AGRAFES POUR LIGATUREUSE DF 16

WACKER NEUSON



remplace ELO20858

RÉF. ART.
EL100387

FIL A LIGATURER MAKITA

MAKITA



POUR DTR180 - PAR 50 RLX

RÉF. ART.
EL020715

FIL À LIGATURER

MAX

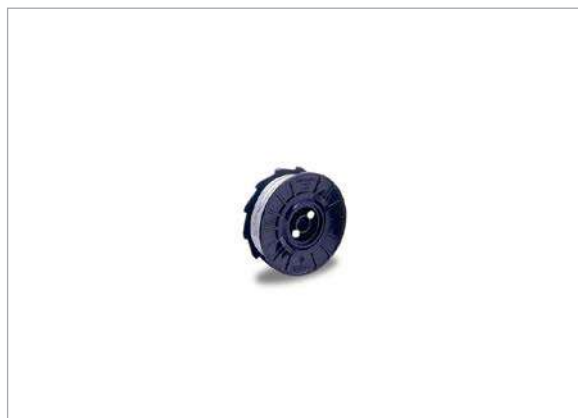

PISTOLET A LIGATURER MAX RB 218_PISTOLET A LIGATURER
MAX RB 398
ROULEAU DE 95 ML

RÉF. ART.
EL005788

BOBINE DE FIL EN ACIER BRUT

MAX



PISTOLET A LIGATURER MAX RB 655
BOBINE DE FIL ACIER BRUT TW1525 POUR RB655 A

RÉF. ART.
EL008941

photos non contractuelles

MALAXEUR 1600W COMPLET AVEC TIGE

SIDAMO



RÉF. ART.	DESCRIPTION
EL005212	DIAM140MM

MALAXEUR TIGE POUR PERCEUSE ÉLECTRIQUE

SOFOP TALIAPLAST



RÉF. ART.	DESCRIPTION
EL005679	AVEC VAPIATEUR

MÉLANGEUR DE PEINTURE ADAPTÉ À PERCEUSE

MILBOX



AI114

RÉF. ART.	DESCRIPTION
EL003221	(JUSQU'À EPUISEMENT)

TIGE DOUBLE HELICE

SIDAMO



MALAXEUR MALAX160

RÉF. ART.	DESCRIPTION
EL004481	POUR MALAXEUR ÉLECTRIQUE EL005212

DÉCOUPEUR UNIVERSEL CP100DWA MAKITA

MAKITA



we
life
b
DISTRIPUS

Avec 2 batteries+chargeur 12V

RÉF. ART.
EL020872

DÉCOUPEUSE DE FERS À BÉTON GR20E FIL D.20MM MAX



we
life
b
DISTRIPUS

Découpeuse de fers à béton 1200W - Disque Ø110mm - Poids :
3,5kg - Livrée en malette avec 2 disques

RÉF. ART.
EL008528

DECOUPEUSE DE FERS GR20B



we
life
b
DISTRIPUS

RÉF. ART.	DESCRIPTION	REFERENCE FABRICANT
EL107124	SUR BATTERIE AVEC 2 BATTERIES	GR20B

DÉCOUPEUSE DE FERS MAKITA

MAKITA



we
life
b
DISTRIPUS

Découpe d'aciers et de tiges filetées sans bavure jusqu'à 25mm -
4kg - coupe à ras 3mm

RÉF. ART.	DESCRIPTION	REFERENCE FABRICANT
EL018578	DSC251RT	DSC251RT

photos non contractuelles

MEULEUSE 230 SUR BATTERIE 2X18v/5a MAKITA DGA900PT4

MAKITA



we
life
b
DISTRIPUS

2*18 V - 5Ah - Ø230 mm - Carter protection meulage et tronçonnage - Profondeur max : 60 mm - 5.2 kg (avec batterie) - **
Idéal en espace ou accès restreint. Kit d'aspiration spécifique pour rainurage à commander séparément. Autonomie et puissance limitée**

RÉF. ART.

EL020165

MEULEUSE DROITE 18V-FEIN AGSZ 18-280 LBL



we
life
b
DISTRIPUS

18V - Tronçonnage, ponçage, ébavurage et fraisage - Meule diamètre max 50mm - Eclairage LED intégré - 2,3 kg avec batterie - Machine vendue sans batterie. Prévoir le pack 2 batteries + chargeur EL020218

RÉF. ART.

EL020167

KIT MEULEUSE D'ANGLE AG 230



carter de protection pour meulage carter de protection pour tronçonnage kit d'aspiration pour la découpe de béton sac de de transport

RÉF. ART.

DESCRIPTION

REFERENCE FABRICANT

EL020240

-27DB 230V

3700886

WIZOM REHABILITATION LOT DE 200 STICKS PORTE



we
life
b
DISTRIPUS

Filaire - 750 W - Vitesse de rotation variable - 1,8 kg - Meulage et ébavurage dans endroits exigus

RÉF. ART.

DESCRIPTION

EL020166

MEULEUSE DROITE FEIN GSZ 8-280 PEL

photos non contractuelles

SCIE CARRELAGE DIAMINIPRO 180

SIDAMO



RÉF. ART.	DESCRIPTION	REFERENCE FABRICANT
EL106821	AVEC DISQUE PRO CERAM-E 180	20116066

DISQUE DIAMANT PRO CERAM-E

SIDAMO



RÉF. ART.	DESCRIPTION	REFERENCE FABRICANT
EL106822	D. 180 x 30-25,4-22,23 x h 7	11130037

photos non contractuelles

DISQUE POUR DECOUPEUSE DE FERS A BETON GR20E



RÉF. ART.	DESCRIPTION	REFERENCE FABRICANT
EL008592	Disque Ø110	TCT110
EL112045	Disque Ø110 / 24 dents	TCT110S/10

DISQUE A TRONCONNER EQD



MEULEUSE HILTI DCG 230-DB

Nouveaux disques diamant pour la découpe de béton et pierre naturel - 0 - - 1 - 5

RÉF. ART.	DESCRIPTION	LON- GUEUR	DIAMETRE	REFERENCE FABRICANT
EL001816	DISQUE A TRONC EQD 230/22 SPX UNIVERSEL	L 06 MM	D 230 MM	2117965
EL010512	DISQUE A TRONC EQD SPX 230/22 DOUX	L 22 MM	D 230 MM	2118060
EL010823	DISQUE A TRONC EQD SPX 400/25 UNIVERSEL	L 25 MM	D 400 MM	2117978

DISQUE A TRONCONNER A24 R



TRONCONNEUSE HILTI DSH 700_TRONCONNEUSE HILTI DSH 900

Disques Bakélite pour tronçonneuse thermique - 0 - 10 - 10

RÉF. ART.	DESCRIPTION	LON- GUEUR	DIAMETRE	REFERENCE FABRICANT
EL001817	DISQUE A TRONC. A24 R 356X4.2X25.4 MM LOT DE 10	L 04 M	Ep 04,2 D 355 M	361908

DISQUE A TRONCONNER SPX



RÉF. ART.	DESCRIPTION	REFERENCE FABRICANT
EL018341	230/22MM METAL	2200892

DISQUE FINITION BETON 130

HILTI



RÉF. ART.	DESCRIPTION	REFERENCE FABRICANT
EL018588	SPX G.200 LOT DE 6	2207454
EL018587	SPX G.50 LOT DE 6	2207450
EL020905	SPX G.800 LOT DE 6	2238269

Meule diamant 125

HILTI



RÉF. ART.	DESCRIPTION	REFERENCE FABRICANT
EL105609	/5" SPX epoxy PC - UNITE	2238557

DISQUE À MEULER EN ACIER D.230MM

S.E.A.

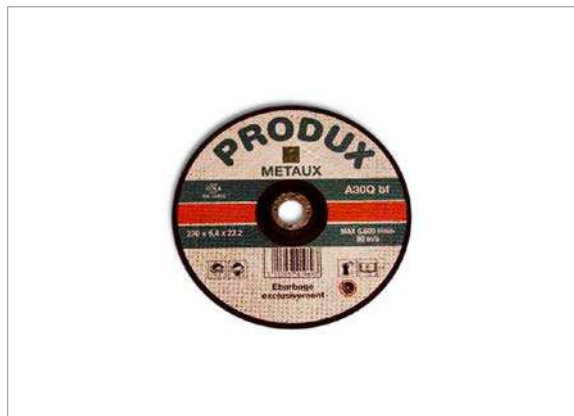

MEULEUSE HILTI DCG 230-DB

RÉF. ART.	DIAMETRE
EL005724	D 230 MM

DISQUE À TRONÇONNER ALÉSAGE EN ACIER D.230MM

S.E.A.



MEULEUSE HILTI DCG 230-DB

RÉF. ART.	DIAMETRE
EL005721	D 230 MM

photos non contractuelles

DISQUE À TRONÇONNER ALÉSAGE EN MATÉRIAUX D.230MM

S.E.A.



MEULEUSE HILTI DCG 230-DB

RÉF. ART.	DIAMETRE
EL005727	D 230 MM

COFFRET 43 MEULES POUR MEULEUSE DROITE EL020166/EL020167



RÉF. ART.
EL020370

DISQUE DIAMANT À JANTE CONTINUE POUR CARRELAGE

OCTADIAM



SCIE CARRELAGE DIAMINIBOX 200

DISQUE DIAMANT CARRELAGE Ø 200 ALESAGE 22,2 JANTE CONTINUE POUR DIAMINIBOX - jusqu'à épuisement

RÉF. ART.	DESCRIPTION
EL010301	D.200MM

DISQUE DIAMANT ALPHALTE / BETON

OCTADIAM



MEULEUSE HILTI DCG 230-DB

DISQUE DIAMANT ALPHALTE / BETON - D.350 MM . ALESAGE 20 à 25,4 - OCTADIAM jusqu'à épuisement

RÉF. ART.	DESCRIPTION	DIAMETRE
EL001861	D.350 MM ALESAGE 20 À 25,4	D 300 MM

photos non contractuelles

DISQUE DIAMANT ASPHALTE D.350

OCTADIAM



DISQUE DIAMANT ASPHALTE D.350 X 3,2 X 10 ALESAGE 25,4
MACHINE 13CV - jusqu'à épauement

RÉF. ART.	DESCRIPTION
EL009018	MM POUR MACHINE 13CV
EL009017	MM POUR MACHINE 9CV

DISQUE DIAMANT

OCTADIAM



- jusqu'à épauement

RÉF. ART.	DESCRIPTION
EL009019	BETON Ø 230 X2,6 X 10 ALESAGE 22,2

**DISQUE DIAMANT MIXE ASPHALTE/
BÉTON**

OCTADIAM



MEULEUSE HILTI DCG 230-DB

RÉF. ART.	DESCRIPTION	DIAMETRE
EL005738	DISQUE DIAMANT D.230MM - jusqu'à épauement	
EL001864	TÔLE SILENCIEUSE D.300MM	D 300 MM
EL009015	DISQUE DIAMANT MIXTE ASPHALTE/BETON D.350 MM	
EL009016	DISQUE DIAMANT MIXTE ASPHALTE/BETON D.350 MM SILENCIEUX	

DISQUE DIAMANT UNIVERSEL

OCTADIAM



MEULEUSE HILTI DCG 230-DB

RÉF. ART.	DESCRIPTION	DIAMETRE
EL001868	D.230MM - jusqu'à épauement	D 230 MM
EL009025	TÔLE SILENCIEUSE D.230MM	

photos non contractuelles

DISQUE POUR DÉCOUPEUSE FERS À BÉTON



DECOUPEUSE ATDV GR20E
Disque Premium Ø 110mm 24 dents pour GR20E

RÉF. ART.	DESCRIPTION	DIAMETRE
EL008592	GR20E	D 110 MM

DISQUE XTREME



MEULEUSE HILTI DCG 230-DB

Très performant dans les bétons très durs, performant dans les matériaux - 1

RÉF. ART.	DESCRIPTION	DIAMETRE	REFERENCE FABRICANT
EL007578	BETON D. 230 *	D 230 MM	610096
EL007579	MACON. D.230 *	D 230 MM	610103

LAME COUPE FER A BETON POUR DSC251RT

MAKITA



RÉF. ART.	DESCRIPTION
EL020352	(EL018578)

PACK 2 DISQUES DIAM. 150



RAINUREUSE SPIT D90E

RÉF. ART.	DESCRIPTION	DIAMETRE	REFERENCE FABRICANT
EL007570	SILVER TURBO T	D 150 MM	610035

PACK 2 DISQUES XTREME



RAINUREUSE SPIT D90E

RÉF. ART.	DESCRIPTION	DIAMETRE	REFERENCE FABRICANT
EL007574	BETON D.150	D 150 MM	610063
EL007586	UNIVERSEL D.150	D 150 MM	610197

AUTRES CONSOMMABLES MEULAGE
DECOUPAGE

DESCRIPTION
Vous rapprocher de votre interlocuteur Distrimo

photos non contractuelles

PERCEUSE PERCUSSION UD 30

HILTI



Une seule cheville pour tous les supports creux de 10 à 92 mm - 100 - 25

RÉF. ART.	DESCRIPTION	PUISSANCE	REFERENCE FABRICANT
EL005268	230V	P 650 W	211974

COUTEAU OSCILLANT FILAIRE DREMEL 4300

DREMEL

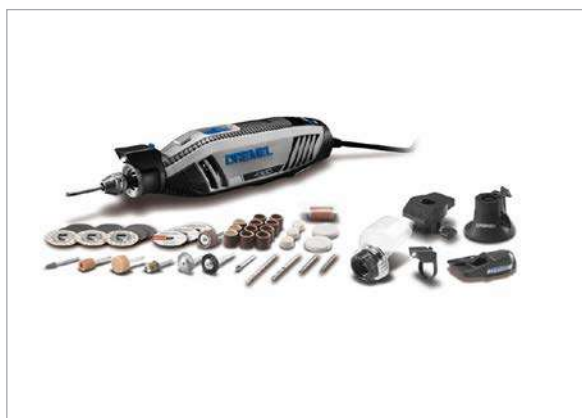

175W - 0,66kg - Découpe, meulage, perçement de précision

RÉF. ART.
EL020178

PERCEUSE BATTERIE MÉTAL FEIN ASCM18 - SANS BATTERIE



Perceuse visseuse métal - Batterie 18 V - Perçage et taraudage jusqu'à 12 mm - 2,2 kg (avec batterie) - Machine vendue sans batterie. Prévoir le pack 2 batteries + chargeur EL020218

RÉF. ART.
EL020172

PERCEUSE FILAIRE MÉTAL FEIN BOS 16



Perceuse à deux vitesses jusqu'à 16 mm - Filaire 1200 w - 3,7 k

RÉF. ART.
EL020173

PERCEUSE MAGNÉTIQUE FEIN KBM



1200 W - Ø max. de la fraise carbure 50 mm - Ø max. de la fraise HSS 40 mm - Profondeur perçage max. fraise 50 (75*) mm - 13,9 kg

RÉF. ART.	DESCRIPTION
EL020174	50 U
EL020175	65 U

UNITE DE PERCAGE MAGNETIQUE UNIVERSELLE



RÉF. ART.	DESCRIPTION	REFERENCE FABRICANT
EL112237	JUSQU'A 110MM	KBU 110-4 M

VISSEUSE PERCEUSE MAKITA DDF481RTE

MAKITA



Batterie 18V - Vitesse à vide 2100 tr/mn - Couple maxi 115 Nm - 2,6 kg

RÉF. ART.
EL017079

photos non contractuelles

MANDRIN SERRAGE RAPIDE 13**HILTI**

PERCEUSE HILTI UD30 _PERCEUSE HILTI SFH 22-A_PERCEUSE SPIT IDI 246

RÉF. ART.	REFERENCE FABRICANT
EL002824	60208

ADAPTATEUR FRAISE POUR PERCEUSE FEIN

POUR PERCEUSE EL020172

RÉF. ART.
EL020207

ADAPTATEUR DOUILLE POUR PERCEUSE FEIN

POUR PERCEUSE EL020172

RÉF. ART.
EL020204

ADAPTATEUR TARAUD POUR PERCEUSE FEIN

POUR PERCEUSE EL020172

RÉF. ART.
EL020205

photos non contractuelles

EJECTEUR FRAISE



RÉF. ART.	DESCRIPTION
EL100647	100 MM FEIN
EL100648	125 MM FEIN
EL100649	135 MM FEIN
EL100646	82 MM FEIN

FRAISE 25



AVEC REVETEMENT TITAN

RÉF. ART.	DESCRIPTION
EL020402	AU CARBURE
EL020209	POUR PERCEUSE FEIN

FORET DE CENTRAGE FEIN



RÉF. ART.	DESCRIPTION
EL020238	63114038010
EL020239	63114038020

FRAISE CARBURE ULTRA



RÉF. ART.	DESCRIPTION
EL100650	D12 L35 QI FEIN
EL100651	D14 L35 QI FEIN
EL100652	D16 L35 QI FEIN
EL100653	D18 L35 QI FEIN
EL100654	D20 L35 QI FEIN
EL100655	D24 L35 QI FEIN

photos non contractuelles

FRAISE HSS DURA



RÉF. ART.	DESCRIPTION
EL100656	50MM FEIN

HUILE DE COUPE EN SPRAY



POUR PERCEUSES MAGNETIQUES FEIN

RÉF. ART.
EL020208

PORTE EMBOUT POUR PERCEUSE FEIN



POUR PERCEUSE EL020172

RÉF. ART.
EL020203

RENOI D'ANGLE POUR PERCEUSE FEIN



POUR PERCEUSE EL020172

RÉF. ART.
EL020206

FRAISE CONIQUE HSS

HILTI



PERCEUSE HILTI UD30 _PERCEUSE HILTI SFH 22-A_PERCEUSE SPIT IDI 246

Mèche pour fraisage et ébavurage des trous dans le métal

RÉF. ART.	DESCRIPTION	REFERENCE FABRICANT
EL013413	CS M3-M10 (D6.3-20.5)	2074630

MECHE ACIER ETAGEE

HILTI



PERCEUSE HILTI UD30 _PERCEUSE HILTI SFH 22-A_PERCEUSE SPIT IDI 246

Mèche pour le métal - Pour acier

RÉF. ART.	DESCRIPTION	LONGUEUR	REFERENCE FABRICANT
EL002875	4-20	L 48 MM	304983

MECHE BOIS PLATE WDB

HILTI



PERCEUSE HILTI UD30 _PERCEUSE HILTI SFH 22-A_PERCEUSE SPIT IDI 246

Extension de mèche de pelle

RÉF. ART.	DESCRIPTION	LONGUEUR	DIAMETRE	REFERENCE FABRICANT
EL010402	-S-H1/4 E6	L 152 MM		2033438
EL014063	-S-H6 10X152		D 10 MM	2025567
EL014064	-S-H6 12X152		D 12 MM	2025568
EL014065	-S-H6 14X152		D 14 MM	2025569
EL010368	-S-H6 16 A 32 JEU (BOIS)	L 152 MM		2025582
EL010403	-S-H6 16X152	L 152 MM	D 16 MM	2025570
EL014066	-S-H6 18X152		D 18 MM	2025571
EL010404	-S-H6 20X152	L 152 MM	D 20 MM	2025572
EL014067	-S-H6 22X152		D 22 MM	2025573
EL014068	-S-H6 24X152		D 24 MM	2025574
EL014069	-S-H6 25X15		D 25 MM	2025575
EL009160	-S-H6 26X152	L 152 MM	D 26 MM	2025576
EL014070	-S-H6 28X152		D 28 MM	2025577
EL014071	-S-H6 30X152		D 30 MM	2025578
EL014072	-S-H6 32X152		D 32 MM	2025579
EL014073	-S-H6 35X152		D 35 MM	2025580
EL014074	-S-H6 38X152		D 38 MM	2025581
EL010045	-S-H6 6X152	L 152 MM	D 06 MM	2025565
EL014075	-S-H6 8X152		D 08 MM	2025566

photos non contractuelles

MECHE BOIS SPIRALE

HILTI



PERCEUSE HILTI UD30 _PERCEUSE HILTI SFH 22-A_PERCEUSE SPIT IDI 246

Mèche pour le bois - Pour perçage dans le bois - diamètre X longueur utile/longueur totale

RÉF. ART.	DESCRIPTION	LONGUEUR	DIAMETRE	REFERENCE FABRICANT
EL002877	10X255/320	L 320 MM	D 10 MM	304989
EL002891	24X255/320	L 460 MM	D 24 MM	2128502
EL002901	6X255/320	L 320 MM	D 06 MM	304986
EL002903	8X255/320	L 320 MM	D 08 MM	304988

MECHE ETAGEE

HILTI



PERCEUSE HILTI UD30 _PERCEUSE HILTI SFH 22-A_PERCEUSE SPIT IDI 246

Mèche pour le métal - Pour acier

RÉF. ART.	DESCRIPTION	LONGUEUR	REFERENCE FABRICANT
EL003144	M10-M40	L 72 MM	304984

MECHE HELICOIDALE HSS

HILTI



PERCEUSE HILTI UD30 _PERCEUSE HILTI SFH 22-A_PERCEUSE SPIT IDI 246

Mèche pour le métal - Pour métaux - diamètre X longueur

RÉF. ART.	DESCRIPTION	LONGUEUR	DIAMETRE	REFERENCE FABRICANT
EL003147	10.0X133 BOITE DE 10	L 133 MM	D 10 MM	304931
EL003148	10.5X133 BOITE DE 5	L 133 MM	D 10,5 MM	304932
EL003149	11.0X142 BOITE DE 5	L 142 MM	D 11 MM	304933
EL003150	11.5X142 BOITE DE 5	L 142 MM	D 11,5 MM	304934
EL003151	12.0X151 BOITE DE 5	L 151 MM	D 12 MM	304935
EL003152	12.5X151 BOITE DE 5	L 151 MM	D 12,5 MM	304936
EL003153	13.0X151 BOITE DE 5	L 151 MM	D 13 MM	304937
EL003156	1.5X40 BOITE DE 10	L 40 MM	D 01,5 MM	304899

MECHE HELICOÏDALE HSS

HILTI



PERCEUSE HILTI UD30 _PERCEUSE HILTI SFH 22-A_PERCEUSE SPIT IDI 246

Mèche pour le métal - Pour métaux - diamètre X longueur

RÉF. ART.	DESCRIPTION	REFERENCE FABRICANT
EL003157	1-10 (LE JEU)	405312
EL003160	2-8 (LE JEU)	213950

photos non contractuelles

MECHE HELICOIDALE HSS

HILTI



PERCEUSE HILTI UD30 _PERCEUSE HILTI SFH 22-A_PERCEUSE SPIT IDI 246

Mèche pour le métal - Pour métaux - diamètre X longueur

RÉF. ART.	DESCRIPTION	LONGUEUR	DIAMETRE	REFERENCE FABRICANT
EL003161	3.0X61 BOITE DE 10	L 61 MM	D 03 MM	304903
EL003163	3.2X65 BOITE DE 10		D 03,2 MM	304904
EL003166	3.75X70 BOITE DE 10		D 03,75 MM	304909
EL003167	4.0X75 BOITE DE 10		D 04 MM	304910
EL003170	4.2X75 BOITE DE 10		D 04,2 MM	304912
EL003171	4.5X80 BOITE DE 10	L 80 MM	D 04,5 MM	304914
EL003173	5.0X86 BOITE DE 10	L 86 MM	D 05 MM	304916
EL003175	5.2X86 BOITE DE 10	L 86 MM	D 05,2 MM	304917
EL003176	5.3X86 BOITE DE 10	L 86 MM	D 05,3 MM	304919
EL003177	5.5X93 BOITE DE 10	L 93 MM	D 05,5 MM	304920
EL003179	5.7X93 BOITE DE 10	L 93 MM	D 05,7 MM	304921
EL003180	6.0X93 BOITE DE 10	L 93 MM	D 06 MM	304923
EL003181	6.5X101 BOITE DE 10	L 101 MM	D 06,5 MM	304924
EL003182	7.0X109 BOITE DE 10	L 109 MM	D 07 MM	304925
EL003183	7.5X109 BOITE DE 10	L 109 MM	D 07,5 MM	304926
EL003184	8.0X117 BOITE DE 10	L 117 MM	D 08 MM	304927
EL003185	8.5X117 BOITE DE 10	L 117 MM	D 08,5 MM	304928
EL003186	9.0X125 BOITE DE 10			304929
EL003210	Ø 1 A 10 (LE JEU)			304938
EL003211	Ø 1 A 13 (LE JEU)			304939

MÈCHE HELICOÏDALE HSS CO

HILTI



PERCEUSE HILTI UD30 _PERCEUSE HILTI SFH 22-A_PERCEUSE SPIT IDI 246

Mèche pour le métal - Pour métaux - diamètre X longueur

RÉF. ART.	DESCRIPTION	DIAMETRE	REFERENCE FABRICANT
EL014216	18.0X191MM	D 18 MM	2071179
EL014211	6,5X101MM MP10 LOT DE 10	D 06,5 MM	2071155

photos non contractuelles

MECHE HELICOIDALE HSS COB.

HILTI



PERCEUSE HILTI UD30 _PERCEUSE HILTI SFH 22-A_PERCEUSE SPIT IDI 246

Mèche pour le métal - Pour métaux - diamètre X longueur

RÉF. ART.	DESCRIPTION	LON- GUEUR	DIAMETRE	REFERENCE FABRICANT
EL003188	MECHE HELICOIDALE HSS COB Ø 1 A 10 (LE JEU)			2072848
EL003189	10.0X133 BOITE DE 10	L 133 MM	D 10 MM	2071167
EL003190	11.0X142 BOITE DE 5	L 142 MM	D 11 MM	2071170
EL003191	12.0X151 BOITE DE 5	L 151 MM	D 12 MM	2071172
EL003193	2.0X49 BOITE DE 10	L 49 MM	D 02 MM	2071113
EL003194	2.5X43 BOITE DE 10	L 43 MM	D 02,5 MM	2071115
EL003195	3.0X61 BOITE DE 10	L 61 MM	D 03 MM	2071117
EL003196	3.2X65 BOITE DE 10	L 65 MM	D 03,2 MM	2071118
EL003197	3.5X70 BOITE DE 10	L 70 MM	D 03,5 MM	2071132
EL003198	3.75X70 BOITE DE 10	L 70 MM	D 03,75 MM	2071133
EL003199	4.0X75 BOITE DE 10	L 75 MM	D 04 MM	2071134
EL003200	4.2X75 BOITE DE 10	L 75 MM	D 04,2 MM	2071136
EL003201	4.5X80 BOITE DE 10	L 80 MM	D 04,5 MM	2071138
EL003203	5.0X86 BOITE DE 10	L 86 MM	D 05 MM	2071142
EL003204	5.5X93 BOITE DE 10	L 93 MM	D 05,5 MM	2071148
EL003205	6.0X93 BOITE DE 10	L 93 MM	D 06 MM	2071154
EL003206	7.0X109 BOITE DE 10	L 109 MM	D 07 MM	2071160
EL003207	8.0X117 BOITE DE 10	L 117 MM	D 08 MM	2071162
EL003208	9.0X125 BOITE DE 10	L 125 MM	D 09 MM	2071164
EL003192	UNITÉ	L 151 MM	D 13 MM	2071174
EL003209	MECHE HELICOIDALE HSS COBALT Ø 1 A 13 (LE JEU)			2072849

MÈCHE HÉLICOÏDALE HSS-R

HILTI

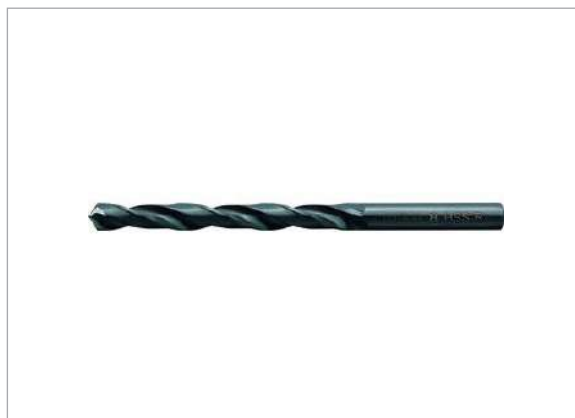

RÉF. ART.	DESCRIPTION	REFERENCE FABRICANT
EL019962	1.0X34MM MP10 lot de 10	2170621
EL019963	1.5X40MM MP10 LOT de 10 x2	2170622
EL019964	10.0X133MM MP10 LOT DE 10	2170680
EL019965	10.5X133MM MP5LOT DE 5	2170681
EL019966	11.0X142MM MP5 LOT DE 5	2170682
EL019967	11.5X142MM MP5 LOT DE 5	2170683
EL019969	12.0X151MM MP5 LOT DE 5	2170684
EL019970	12.5X151MM MP5 LOT DE 5	2170685
EL019971	13.0X151MM MP5 LOT DE 5	2170686
EL019972	14.0X160MM	2170687
EL019973	15.0X169MM	2170688
EL019974	16.0X178MM	2170689
EL019975	17.0X184MM	2170690
EL019976	18.0X191MM	2170691
EL019977	2.0X49MM MP10 LOT DE 10	2170623
EL019978	2.5X57MM MP10 LOT DE 10	2170624
EL019979	3.0X61MM MP10LOT DE 10	2170625
EL019980	3.2X65MM MP10 LOT DE 10	2170626
EL019981	3.3X65MM MP10 LOT DE 10	2170627
EL019982	3.5X70MM MP10 LOT DE 10	2170628
EL019983	3.75X70MM MP10 LOT DE 10	2170629
EL019984	4.0X75MM MP10 LOT DE 10	2170660
EL019985	4.1X75MM MP10 LOT DE 10	2170661
EL019986	4.2X75MM MP10 LOT DE 10	2170662
EL019987	4.5X80MM MP10 LOT DE 10	2170663
EL019988	4.75X80MM MP10 LOT DE 10	2170664
EL019989	5.0X86MM MP10 LOT DE 10	2170665
EL019990	5.1X86MM MP10 LOT DE 10	2170666
EL019991	5.25X86MM MP10 LOT DE 10	2170668
EL019992	5.2X86MM MP10 LOT DE 10	2170667
EL019993	5.5X93MM MP10 LOT DE 10	2170669
EL019994	5.7X93MM MP10 LOT DE 10	2170670
EL019995	6.0X93MM MP10 LOT DE 10	2170671
EL019996	6.5X101MM MP10 - LOT DE 10	2170672
EL019997	6.8X109MM MP10 LOT DE 10	2170673
EL019998	7.0X109MM MP10 LOT DE 10	2170674
EL019999	7.5X109MM MP10 LOT DE 10	2170675
EL020000	8.0X117MM MP10 LOT DE 10	2170676
EL020001	8.5X117MM MP10 LOT DE 10	2170677
EL020002	9.0X125MM MP10 LOT DE 10	2170678
EL020003	9.5X125MM MP10LOT DE 10	2170679

photos non contractuelles

MECHE POUR MACONNERIE

HILTI



PERCEUSE HILTI UD30 _PERCEUSE HILTI SFH 22-A_PERCEUSE SPIT IDI 246
diamètre X longueur

RÉF. ART.	DESCRIPTION	LONGUEUR	DIAMETRE	REFERENCE FABRI-CANT
EL003212	10X120	L 120 MM	D 10 MM	305057
EL003214	5X150 BOITE DE 5	L 150 MM	D 05 MM	305051
EL003215	5X85 BOITE DE 5	L 85 MM	D 05 MM	305050
EL003216	6X100 BOITE DE 5	L 100 MM	D 06 MM	305052
EL003218	8X120	L 120 MM	D 08 MM	305055

MÈCHE SPIRALE HEX

HILTI



PERCEUSE HILTI UD30 _PERCEUSE HILTI SFH 22-A_PERCEUSE SPIT IDI 246

Mèche de perçage à percussion de 7/16" (pouces) pour le forage lisse de trous profonds en bois

RÉF. ART.	DESCRIPTION	LONGUEUR	DIAMETRE	REFERENCE FABRI-CANT
EL014234	12 X 255 / 320	L 320 MM	D 12 MM	2128490
EL014235	12 X 400 / 460	L 460 MM	D 12 MM	2128491
EL014236	14 X 255 / 320	L 320 MM	D 14 MM	2128492
EL014237	14 X 400 / 460	L 460 MM	D 14 MM	2128493
EL014238	16 X 255 / 320	L 320 MM	D 16 MM	2128494
EL014239	16 X 400 / 460	L 460 MM	D 16 MM	2128495
EL014240	18 X 255 / 320	L 320 MM	D 18 MM	2128496
EL014241	18 X 400 / 460	L 460 MM	D 18 MM	2128497
EL014242	20 X 255 / 320	L 320 MM	D 20 MM	2128498
EL014243	20 X 400 / 460	L 460 MM	D 20 MM	2128499
EL014244	22 X 255 / 320	L 320 MM	D 22 MM	2128500
EL014245	22 X 400 / 460	L 460 MM	D 22 MM	2128501
EL014246	26 X 160 / 235	L 235 MM	D 26 MM	2128503
EL014247	26 X 255 / 320	L 320 MM	D 26 MM	2128504
EL014248	28 X 255 / 320	L 320 MM	D 28 MM	2128505
EL014249	30 X 255 / 320 -	L 320 MM	D 30 MM	2128506
EL014250	32 X 255 / 320	L 320 MM	D 32 MM	2128507

photos non contractuelles

RALLONGE DE MECHE BOIS PLATE

HILTI

PERCEUSE HILTI UD30 _PERCEUSE HILTI SFH 22-A_PERCEUSE SPIT IDI 246
Extension de mèche de pelle

RÉF. ART.	DESCRIPTION	LONGUEUR	REFERENCE FABRICANT
EL009161	WDB-S-H1/4 E12	L 304 MM	2025583

COFFRET 19 FORETS HSS

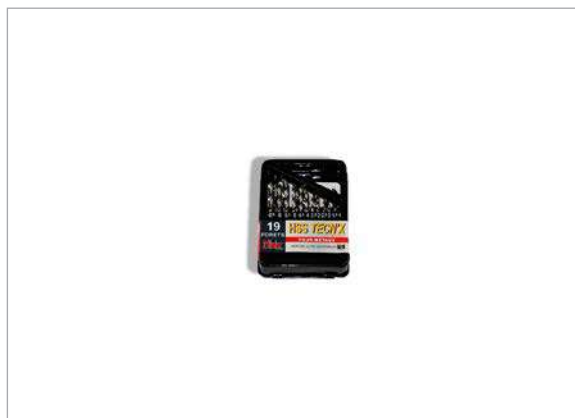
riss

PERCEUSE SPIT IDI 246_PERCEUSE SFH 22-A_PERCEUSE HILTI UD30

RÉF. ART.	DESCRIPTION
EL001180	D.1-10MM - USAGE OCCASIONNEL

TARAUD HSS TB

HILTI

Mèche de taraudage pour taraudage en métal

RÉF. ART.	DESCRIPTION	REFERENCE FABRICANT
EL014920	M10	2113244
EL014923	M3-M12 + HSS JEU	2113249
EL014924	M3-M12 JEU	2113248
EL014925	M4	2113240
EL014926	M5	2113241
EL014927	M6	2113242
EL014928	M8	2113243

COFFRET FORETS À BÉTON

riss

PERCEUSE SPIT IDI 246_PERCEUSE SFH 22-A_PERCEUSE HILTI UD30

RÉF. ART.	DESCRIPTION
EL001184	D.4-10MM

COFFRET FORETS EN ACIER

riss



PERCEUSE SPIT IDI 246_PERCEUSE SFH 22-A_PERCEUSE HILTI UD30

RÉF. ART.	DESCRIPTION
EL001185	D.1-13MM

COFFRET SCIE CLOCHE ARTISAN 5 SCIES + MADARIN + ADAPTEUR

riss



PERCEUSE SPIT IDI 246_PERCEUSE SFH 22-A_PERCEUSE HILTI UD30

COFFRET SCIE CLOCHE ARTISAN (5 SCIES $\text{Æ}22$ A 38mm + 1 MANDRIN + 1 ADAPTATEUR)

RÉF. ART.
EL001199

COFFRET SCIE CLOCHE ELEC 22 A 64MM + 2 MANDRINS + 1 ADAPT.

riss



PERCEUSE SPIT IDI 246_PERCEUSE SFH 22-A_PERCEUSE HILTI UD30

COFFRET SCIE CLOCHE ELECTRICIEN (6 SCIES $\text{Æ}22$ A 64mm + 2 MANDRINS + 1 ADAPTATEUR)

RÉF. ART.
EL001200

FORET COBALT 5%

riss



USAGE INTENSIF

RÉF. ART.	DESCRIPTION
EL100582	D.3.0MM
EL100583	D.3.5MM
EL100584	D.4.0MM
EL100585	D.4.2MM
EL100586	D.4.5MM
EL100587	D.5.0MM
EL100588	D.5.5MM
EL100589	D.6.0MM
EL100590	D.6.5MM
EL100591	D.7.0MM
EL100592	D.8.0MM
EL100593	D.8.5MM
EL100594	D.10MM
EL100595	D.12MM
EL100596	D.13MM

photos non contractuelles

FORET ACIER LAMINE HSS

riss



PERCEUSE SPIT IDI 246_PERCEUSE SFH 22-A_PERCEUSE HILTI UD30
USAGE OCCASIONNEL

RÉF. ART.	DESCRIPTION	DIAMETRE
EL002316	D.3MM	D 3 MM
EL002317	D.3.5MM	D 3,5 MM
EL002320	D.4.2MM	D 4,2 MM
EL002318	D.4MM	D 4 MM
EL002321	D.5MM	D 5 MM
EL002310	D.6.5MM	
EL002323	D.6MM	D 6 MM
EL002324	D.8MM	D 8 MM
EL002311		
EL002312		
EL002313	D.10MM	D 10 MM
EL002322		
EL002326		
EL002314	D.12MM	D 12 MM
EL002315	D.13MM	D 13 MM

FORETS ÉTAGÉS À DOUBLE TRANCHANT
QUEUE CYLINDRIQUE

SAM OUTILLAGE

RÉF. ART.	DESCRIPTION
EL103604	4 A 30MM

FORETS MULTICONSTRUCTION

BOSCH



RÉF. ART.	DESCRIPTION
EL020656	CYL-9 COFFRET 7 FORETS

MÈCHE À BOIS EXTENSIBLE

riss



PERCEUSE SPIT IDI 246_PERCEUSE SFH 22-A_PERCEUSE HILTI UD30
QUEUE CYLINDRIQUE

RÉF. ART.	DESCRIPTION	DIAMETRE
EL002876	I.15-45MM	D 15/45 MM

MÈCHE À BOIS PLATE

riss



PERCEUSE SPIT IDI 246_PERCEUSE SFH 22-A_PERCEUSE HILTI UD30

RÉF. ART.	DESCRIPTION	DIAMETRE
EL002857	À QUEUE CYLINDRIQUE D.3-10MM - JEU DE 8	
EL005497	D.22MM	D 22 MM
EL007048	D.25MM	D 25 M
EL002856	D.40MM	D 40 MM

MÈCHE À BOIS SPIRALE

riss



PERCEUSE SPIT IDI 246_PERCEUSE SFH 22-A_PERCEUSE HILTI UD30

RÉF. ART.	DESCRIPTION	DIAMETRE
EL002905	D.10MM	D 10 MM
EL002906	D.12MM	D 12 MM
EL002907	D.14MM	D 14 MM
EL002908	D.16MM	D 16 MM
EL002909	D.18MM	D 18 MM
EL002910	D.20MM	D 20 MM
EL002911	D.22MM	D 22 MM
EL002912	D.24MM	D 24 MM
EL002913	D.26MM	D 26 MM
EL002914	D.28MM	D 28 MM
EL002915	D.30MM	D 30 MM

MECHE BOIS SELFCUT SPEED 13 MECHE PLATES

BOSCH



RÉF. ART.

EL020655

SCIES TREPANS ELECTRICIEN KIT

BOSCH



RÉF. ART.

DESCRIPTION

EL020674

20/22/25/32/35/40/44/51/60/68/76

EL020673

19/25/38/44/68/83

EL020672

22/29/35/44/51/65

photos non contractuelles

Kit TE 300 A36

HILTI



we
life
b
DISTRIPUS

Prévoir c4 36 plus b36 en 5,2 A

RÉF. ART.	DESCRIPTION	REFERENCE FABRICANT
EL104929	Kit TE 300-A36 (NU) + TE DRS-C (remplace EL018356)	3703159

BURINEUR TE 500-AVR

HILTI



we
life
b
DISTRIPUS

remplace le EL004907

RÉF. ART.	DESCRIPTION	REFERENCE FABRICANT
EL020463	230V	2146841

Kit TE300

HILTI



we
life
b
DISTRIPUS

RÉF. ART.	DESCRIPTION	REFERENCE FABRICANT
EL104928	Kit TE 300-AVR + TE DRS-C 220V	3703160

BURINEUR TE 700-AVR SDSMAX

HILTI



we
life
b
DISTRIPUS

Burineur avec système anti-vibratoire - remplace EL004908

RÉF. ART.	DESCRIPTION	PUISSANCE	REFERENCE FABRICANT
EL009433	- 7,9KG - 1300W - 11,5J	P 1300 W	428939

Kit TE 1000 AVR

HILTI



we
life
b
DISTRIPUS

avec câble longueur 4m

RÉF. ART.	DESCRIPTION	REFERENCE FABRICANT
EL105475	Câble Universel - KIT (remplace EL004904)	3654298

BURINEUR TE 2000-AVR

HILTI



we
life
b
DISTRIPUS

RÉF. ART.	REFERENCE FABRICANT
EL018515	2155477

PERFORATEUR BURINEUR DHR243RTJW
18V MAKITA

MAKITA



we
life
b
DISTRIPUS

2 ACCUS 18V/A4 + CHARGEUR + KIT ASPIRATION DX02 [18V - 2 J - 4,7kg (kit cis)]

RÉF. ART.
EL010304

PERFORATEUR BURINEUR MAKITA
DHR400PG2U

MAKITA



we
life
b
DISTRIPUS

36V (2x18V) - SDSMax - 8 Joules - Diamètre max béton : 40mm - 8,1kg - **kit d'aspiration spécifique à commander séparément**

RÉF. ART.
EL020163

photos non contractuelles

BURINEUR HK1820-SP SDS+ 550W 3,1J

MAKITA



Piqueur SDS-Plus 550 W

RÉF. ART.

EL008526

BRAS ZERO GRAVITE EKSOZEROG NACELLES + SOL

AZAIRIS

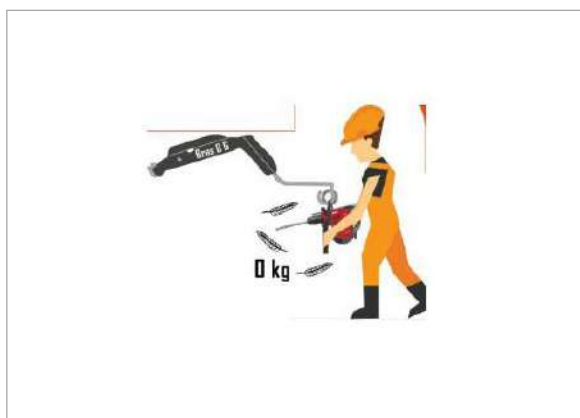

EN COFFRET AVEC SANGLE ET SUPPORTS Pour Percements Burinage Piquage Ponçage- au sul/mur et sur nacelle (contactez Distriplus pour connaître la liste de nacelles validées) Le bras 0 gravité compense le poids des outils jusqu'à 15 kg, Réduit la fatigue et risques TMS, Liberté complète de mouvement

RÉF. ART.

EL018411

PORTIQUE 0 GRAVITE (en test)

IETS

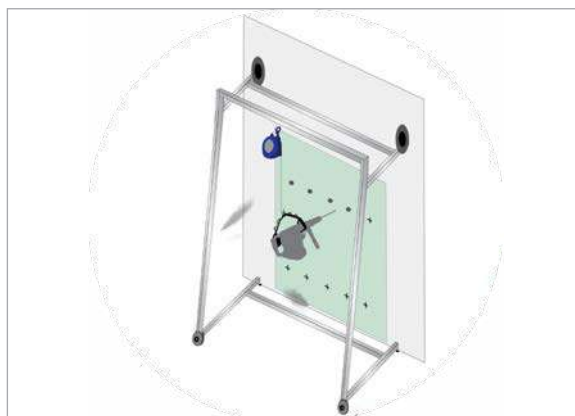

RÉF. ART.	DESCRIPTION	REFERENCE FABRICANT
EL100291	PORTIQUE 0 GRAVITE	CDC102519

POTENCE 0 GRAVITE (en test)

IETS



RÉF. ART.	DESCRIPTION	REFERENCE FABRICANT
EL107648	POTENCE EQUILIBRAGE 9 - 15 KG	MOD102977

photos non contractuelles

PERFORATEUR TE 6-A36 AVR SDS+

HILTI



we
life
b
DISTRIPUS

Perforateur sans fil 36 V polyvalent pour une performance supérieure + TECX -3557293

RÉF. ART.	DESCRIPTION	REFERENCE FABRICANT
EL017224	- 4KG - 5.2Ah - 2J	3557293

KIT CHARGEUR + COFFRET TE-30A

HILTI



we
life
b
DISTRIPUS

RÉF. ART.	REFERENCE FABRICANT
EL020787	3528854

PERFO -BURINEUR TE60 A 36

HILTI



we
life
b
DISTRIPUS

Perforateur sur batterie AC 2 ACCUS ET CHARG - 3570367

RÉF. ART.	DESCRIPTION	PUISSANCE	REFERENCE FABRICANT
EL008527	PERFORATEUR TE 30-A36 ATC AVR SDS+ - 5,5KG - 5.2 Ah - 3,6J	P 03,6 J	3570367
EL018521	EQUIPE		3600839

PERFORATEUR-BURINEUR TE 60- ATC/ AVR

HILTI



we
life
b
DISTRIPUS

remplace EL005216

RÉF. ART.	DESCRIPTION	REFERENCE FABRICANT
EL020565	230 V	2132181

photos non contractuelles

KIT PERFORATEUR TE 70 GENERATION 4

HILTI



remplace TE80 - EL014431

RÉF. ART.	REFERENCE FABRICANT
EL101626	3686625

BOX 0 PENIBILITE

DISTRIMO



Gamme évolutive de dispositifs d'assistance physique répondant à un panel de situations standards. La box 0 pénibilité est assortie d'une aide au choix (PDF / Site web) permettant de sélectionner le produit le plus adapté en fonction des contraintes chantiers.

RÉF. ART.	DESCRIPTION
BOX 0 PENIBILITE	Au travers de notre box, nous vous proposons une variété de produits améliorant l'ergonomie et la productivité de certaines tâches sur le chantier. Pour les découvrir, c'est en scannant le QR code ou bien avec le lien : https://bycnmateriel.odoo.com/aides-ergonomiques-et-de-productivite

photos non contractuelles

ADAPTATEUR TE-FY-BA-C

HILTI



PERFO BURINEUR HILTI TE 60_PERFO BURINEUR HILTI TE 80_PERFO BURINEUR MAKITA DHR243RMJV

RÉF. ART.	DESCRIPTION	REFERENCE FABRICANT
EL000046	ENS	74068

ADAPTATEUR TE-Y-AD

HILTI



BURINEUR MAKITA HM1111C_PERFO BURINEUR HILTI TE 60_PERFO BURINEUR HILTI TE 80
Extension de mèche TE-F pour augmenter la profondeur de forage de tous les forets de marteau SDS max

RÉF. ART.	LONGUEUR	REFERENCE FABRICANT
EL000047	L 290 MM	382390

BLOC ACCU B

HILTI



RÉF. ART.	DESCRIPTION	REFERENCE FABRICANT
EL018761	36 9.0	2183172
EL020605	36/2.6	2098208
EL020458	36/5.2	2098470

CHARGEUR D'ACCU C 4/36

HILTI

RÉF. ART.	DESCRIPTION	REFERENCE FABRICANT
EL011397	-350 110V BOÏ	2028877

CHARGEUR MULTIPLE C 4/36

HILTI



BOULONNEUSE HILTI SIW 14-A_BOULONNEUSE HILTI SIW 22-A_BOULONNEUSE HILTI SIW 22T-A_CLE A CHOC SID 2-A_CLE A CHOC SID 14-A_CLE A CHOC SID 22-A_PERCEUSE HILTI SFH 22-A_PERFORATEUR HILTI TE 2-A22_PERFORATEUR HILTI TE 30-A36_PERFORATEUR HILTI TE 6-A36_SCIE CIRCULAIRE HILTI SCM 22-A_VISSEUSE HILTI SF 14-A_VISSEUSE HILTI SFC 14-A_VISSEUSE HILTI SFH 14-A_VISSEUSE HILTI SF 22-A_VISSEUSE HILTI SFC 22-A_VISSEUSE SPIT HDI 286

Chargeur multi-tension multi-compartiment pour toutes les batteries Li-ion Hilti - Chargement des batteries 14 V, 22 V et 36 V Li-ion Hilti ainsi que des batteries 12 V avec adaptateur

RÉF. ART.	DESCRIPTION	REFERENCE FABRICANT
EL011399	-MC4 230V BOÏ	2108812

photos non contractuelles

CHARGEUR VOITURE C 4/36

HILTI

BOULONNEUSE HILTI SIW 14-A_BOULONNEUSE HILTI SIW 22-A_BOULONNEUSE HILTI SIW 22T-A_CLE A CHOC SID 2-A_CLE A CHOC SID 14-A_CLE A CHOC SID 22-A_PERCEUSE HILTI SFH 22-A_PERFORATEUR HILTI TE 2-A22_PERFORATEUR HILTI TE 30-A36 _PERFORATEUR HILTI TE 6-A36_SCIE CIRCULAIRE HILTI SCM 22-A_VISSEUSE HILTI SF 14-A _VISSEUSE HILTI SFC 14-A _VISSEUSE HILTI SFH 14-A _VISSEUSE HILTI SF 22-A _VISSEUSE HILTI SFC 22-A _VISSEUSE SPIT HDI 286

hargeur de voiture multi-tension DC pour toutes les batteries Hilti Li-ion - Charge les batteries 12 V (avec adaptateur), 14 V, 22 V et 36 V Hilti

RÉF. ART.	DESCRIPTION	REFERENCE FABRICANT
EL011400	-DC BOÏ	2109004

MALETTE A OUTILS KIT-A22

HILTI

RÉF. ART.	DESCRIPTION	REFERENCE FABRICANT
EL011811	TYP 039	2064776

HUILE DE COUPE MC

HILTI

RÉF. ART.	DESCRIPTION	REFERENCE FABRICANT
CO013438	100ML	211981

MALETTE A OUTILS CORD KIT

HILTI

PERFO BURINEUR HILTI TE 6_PERFO BURINEUR HILTI TE 30

RÉF. ART.	DESCRIPTION	REFERENCE FABRICANT
EL011778	SF / SI + TE	2109585

MANDRIN A CLE TE

HILTI



PERFORATEUR HILTI TE 2-S_PERFORATEUR HILTI TE 7_PERFORATEUR HILTI TE 6-A36

RÉF. ART.	DESCRIPTION	REFERENCE FABRICANT
EL002810	15, TE 5, TE 5-A, TE 6-A, TE 6-C	228434
EL002811	16, TE 30, TE 35, TE 40	282342

MANDRIN SERRAGE RAP.

HILTI



PERFORATEUR HILTI TE 2-A22_PERFORATEUR HILTI TE 2-S_PERFORATEUR HILTI TE 7_PERFORATEUR HILTI TE 6-A36

RÉF. ART.	DESCRIPTION	REFERENCE FABRICANT
EL002822	TE 2M/7C/7A/6A LI	224119
EL017245	EMBALLE POUR TE 6	2123166
EL002823	TE 16/ TE 30 te 40 et te 30A	282341

MANDRIN A RENVOI D'ANGLE POUR NOUVEAU TE6 A 36

HILTI



PERFORATEUR TE 6 A36

RÉF. ART.	DESCRIPTION	REFERENCE FABRICANT
EL017738	MANDRIN A RENVOI D'ANGLE	2126158

MANDRIN TE 2-M NG/TE 7-C

HILTI



PERFORATEUR HILTI TE 2-A22_PERFORATEUR HILTI TE 2-S_PERFORATEUR HILTI TE 7_PERFORATEUR HILTI TE 6-A36
Mandrin pour ANCIEN TE 6 A 36 A 36 2 BI 2 BILLES

RÉF. ART.	REFERENCE FABRICANT
EL002826	273118

photos non contractuelles

MANDRIN TE-C/TE 30A

HILTI

PERFORATEUR HILTI TE 30-A36

RÉF. ART.	REFERENCE FABRICANT
EL009791	2052753

MANDRIN TWIST LOCK TE-C SDS+

HILTI

PERFORATEUR HILTI TE 6-A36

RÉF. ART.	REFERENCE FABRICANT
EL002829	343100

photos non contractuelles

PORTE-MANDRIN

HILTI

PERFO BURINEUR HILTI TE 30_ PERFORATEUR HILTI TE 2-A22_ PERFORATEUR HILTI TE 2-S_ PERFORATEUR HILTI TE 7_ PERFORATEUR HILTI TE 30-A36_ PERFORATEUR HILTI TE 6-A36_ PERFORATEUR SPIT 321_ PERFORATEUR SPIT 323

RÉF. ART.	DESCRIPTION	REFERENCE FABRICANT
EL003722	TE-CBFH - #	60459
EL003723	TE-T - #	409378
EL003724	TE-Y-BFH - SDS MAX	263359

RECUPERATEUR DE POUSSIERE TE

HILTI

PERFORATEUR HILTI TE 6-A36

RÉF. ART.	DESCRIPTION	REFERENCE FABRICANT
EL017419	RECUP. POUSSIERE TE DRS-6-A COFFRET POUR NEW TE6A	2098235
EL018576	RECUP. POUSSIERE TE DRS-D	2191207
EL020015	RÉCUPÉRATEUR DE POUSSIÈRE SR DRS	2183224
EL009368	DRS-4-A BOITE	2098487
EL018477	DRS-6-A BOITE	2098238
EL005359	DRS-B BURINAGE -	365944
EL003874	DRS-M	267769
EL010078	DRS-Y COF	2055718
EL014711	RECUPERATEUR DE POUSSIÈRE TE DRS-4-A COF	2098484
EL014710	RECUPERATEUR DE POUSSIÈRE TE-DRS-S	340602

TUBE DE GRAISSE 50 M

HILTI



CLOUEUR POUDRE HILTI DX351_CLOUEUR POUDRE HILTI DX460_AUTRE CLOUEUR POUDRE HILTI
Pour l'entretien de vos appareils

RÉF. ART.	DESCRIPTION	REFERENCE FABRICANT
CO005464	L (remplace H255832)	203086

MELANGEUR TE 22

HILTI



PERCEUSE HILTI UD30 _PERCEUSE HILTI SFH 22-A_PERCEUSE SPIT IDI 246
Pour un mélange homogène

RÉF. ART.	REFERENCE FABRICANT
EL003222	24018

KIT ASPIRATION MAKITA POUR MEULEUSE DGA9000PT4

MAKITA

we
life

RÉF. ART.

EL020271

KIT ASPIRATION MAKITA POUR PERFORATEUR DHR400PG2U

MAKITA

we
life

RÉF. ART.

EL020268

photos non contractuelles

KIT D'ASPIRATION MAKITA. BURINAGE SDS-MAX

MAKITA



PIQUEUR MAKITA HK 1820 - SP_PIQUEUR MAKITA HK1820L_
BURINEUR MAKITA HM1111C
KIT D'ASPIRATION A LA SOURCE POUR ASPIRATEUR VC-3211MX1

RÉF. ART.

EL008608

MANCHETTE RACCORD MACO SERTI ET RACCORD MÂLE 1/2"



RÉF. ART.

EL002779

DESCRIPTION

D.19MM

TUYAU A AIR COMPRIME



RÉF. ART.

EL004558

DIAMETRE

D 19 MM

TUYAU À AIR COMPRIMÉ RENFORCÉ



RÉF. ART.

EL004559

DESCRIPTION

- 15 BARS - RL DE 40ML

DIAMETRE

D 19 MM

MANDRIN SERRAGE MANUEL ADAPTABLE SUR SDS+



PERFORATEUR 321 SPIT_PERFORATEUR 328 SPIT
SDS+ POUR SPIT 320,322, 328, 329C,343 - 1

RÉF. ART.

EL006665

REFERENCE FABRICANT

54348

photos non contractuelles

PORTE TREP. MACON. SDS M.16



RÉF. ART.	REFERENCE FABRICANT
EL007077	110930

TRANSPORT EXPRESS

LE SERVICE TRANSPORT EXPRESS SUR MESURE VOUS ASSURE L'ENLÈVEMENT ET LA LIVRAISON DE COLIS, PLANS, PALETTES ET HORS-GABARIT DANS LES DÉLAIS LES PLUS COURTS.



RÉF. ART.	DESCRIPTION
Transport express	L.BONAVENTURE@bouygues-construction.com j.imboden@bouygues-construction.com

ERGO'APP

PÔLE ERGO BYCN

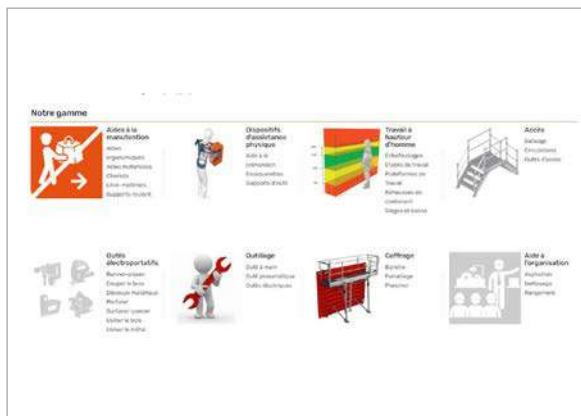

Outil d'aide à la décision permettant d'aider les collaborateurs à choisir les meilleurs outils, matériels ou matériaux selon un besoin et un contexte. Pour chaque produit, l'app propose une carte d'identité détaillée (caractéristiques techniques, photos, liens utiles) et précise pour quel type de tâches il est destiné. Evaluation sur la base de 5 critères : Amélioration de la sécurité, Apport sur la santé, Gain de productivité Intuitivité Poids < 15 kg

RÉF. ART.	DESCRIPTION
ERGO'APP	https://ergoapp.bouygues-construction.com/?lang=fr

photos non contractuelles

BOUCHARDE TE-YP

HILTI

RÉF. ART.	DESCRIPTION	REFERENCE FABRICANT
EL100184	SKHM 4X4 - 2207028 (VENDU A L'UNITÉ)	2207028

BURIN AU MUR TE-SW

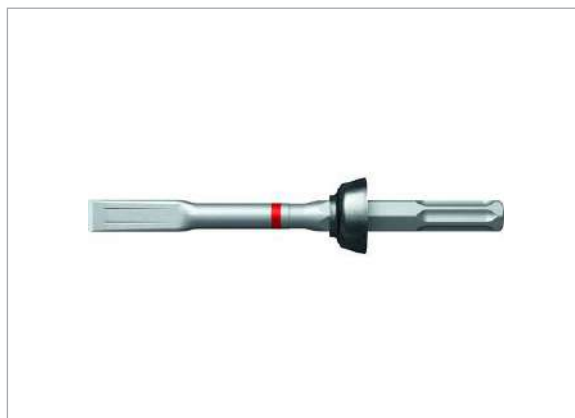
HILTI

RÉF. ART.	DESCRIPTION	REFERENCE FABRICANT
EL011077	FM30	2104283
EL011078	SM30	2104282

BURIN A DEJOINTER

HILTI

PERFO BURINEUR MAKITA DHR243RMJV_PERFORATEUR
HILTI TE 30-A36 _PIQUEUR MAKITA HK 1820

RÉF. ART.	DESCRIPTION	LONGUEUR	LAR-GEUR	REFERENCE FABRI-CANT
EL000344	TE-C SDS+ MM 0.8/18	L 180 MM	I 08 MM	204742
EL000343	TE-C SDS+ FGM 25	L 250 MM	I 32 MM	204741
EL000345	TE-T FGM 28	L 280 MM	I 32 MM	307050

BURIN FLEXIBLE

HILTI

PERFO BURINEUR HILTI TE 30_PERFORATEUR HILTI TE 7_PERFORATEUR HILTI TE 30-A36

RÉF. ART.	DESCRIPTION	REFERENCE FABRICANT
EL011079	TE-C BSPM SDS+	2133864
EL010851	TE-Y BSPM - SDS MAX	2079299

photos non contractuelles

BURIN PLAT TE SPX

HILTI



BURINEUR HILTI TE1000 BURINEUR HILTI TE2000

RÉF. ART.	DESCRIPTION	LONGUEUR	REFERENCE FABRI-CANT
EL018491	BURIN PLAT TE-SPX FM 36	L 360 MM	2168890
EL018763	FM 43	L 430 MM	2168875
EL018479	BURIN PLAT TE-SPX FM 43 (pack de 4)	L 430 MM	2168891
EL018492	BURIN PLAT TE-SPX FM 50	L 500 MM	2168892

BURIN PLAT TE-TP SDS TOP

HILTI



BURINEUR MAKITA HM1111C_PERFO BURINEUR HILTI TE 60_PERFO BURINEUR HILTI TE 80

RÉF. ART.	DESCRIPTION	LONGUEUR	LAR-GEUR	REFERENCE FABRI-CANT
EL000352	BURIN PLAT TE-TP FM 27	L 270 MM	117 MM	282288
EL000353	BURIN PLAT TE-TP FM 35	L 350 MM	117 MM	282289

BURIN PLAT TE-CP SDS +

HILTI



PERFO BURINEUR MAKITA DHR243RMJV_PERFORATEUR HILTI TE 30-A36_PIQUEUR MAKITA HK 1820

RÉF. ART.	DESCRIPTION	LONGUEUR	LAR-GEUR	REFERENCE FABRI-CANT
EL000348	BURIN PLAT TE-CP SDS+ FM25	L 250 MM	115 MM	282301

BURIN PLAT TE-Y SDSMAX

HILTI



PERFO BURINEUR HILTI TE 60_PERFO BURINEUR HILTI TE 80

RÉF. ART.	DESCRIPTION	REFERENCE FABRICANT
EL105347	Burin plat TE-Y SDSMAX RFM 40 MP10 - UNITE	2232600

photos non contractuelles

BURIN PLAT TE-Y-RFM SDSMAX**HILTI**

PERFO BURINEUR HILTI TE 60_PERFO BURINEUR HILTI TE 80

RÉF. ART.	DESCRIPTION	REFERENCE FABRICANT
EL105348	Burin plat TE-Y-RFM SDSMAX 40 MP5 - UNITE	2232610

BURIN POINTU TE-CP SDS PLUS**HILTI**

PERFO BURINEUR MAKITA DHR243RMJV_PERFORATEUR HILTI TE 30-A36 _PIQUEUR MAKITA HK 1820

RÉF. ART.	DESCRIPTION	LONGUEUR	REFERENCE FABRI-CANT
EL000361	BURIN POINTU TE-CP SM25 SDS+	L 250 MM	282299

BURIN POINTU TE-SPX**HILTI**

BURINEUR HILTI TE1000 BURINEUR HILTI TE2000

RÉF. ART.	DESCRIPTION	LONGUEUR	REFERENCE FABRI-CANT
EL018478	SM 43 MP4	L 430 MM	2168888
EL020459	BURIN POINTU TE SPX SM 43		2168871

BURIN POINTU TE-H28P**HILTI**

BURINEUR HILTI TE3000

RÉF. ART.	DESCRIPTION	REFERENCE FABRICANT
EL018287	SM40 ATTENT	2126921
EL020460	SM40 WAVE	2126919
EL018765	SM50 WAVE	2126920

BURIN POINTU TE-SP**HILTI**

BURINEUR HILTI TE1000 BURINEUR HILTI TE2000

RÉF. ART.	DESCRIPTION	LONGUEUR	REFERENCE FABRICANT
EL000364	SM 700 POUR TE-1000	L 700 MM	2168873

photos non contractuelles

BURIN POINTU TE-SPX

HILTI



BURINEUR HILTI TE1000 BURINEUR HILTI TE2000

RÉF. ART.	DESCRIPTION	LONGUEUR	REFERENCE FABRICANT
EL018387	BURIN POINTU TE-SPX SM 36 MP4	L 360 MM	2168887
EL018388	BURIN POINTU TE-SPX SM 50 MP4	L 500 MM	2168889

BURIN POINTU TE-TP SM SDS TOP

HILTI



Burins Système TE-T ou TE-C - Emmanchement SDS Top - Pour TE 16 / 30 /35 / 40-AVR / 46-ATC / 60-ATC-AVR -

RÉF. ART.	DESCRIPTION	LONGUEUR	REFERENCE FABRICANT
EL000366	BURIN POINTU TE-TP SM 35	L 350 MM	282287

BURIN POINTU TE-TP SDS TOP

HILTI



Burins Système TE-T ou TE-C - Emmanchement SDS Top - Pour TE 16 / 30 /35 / 40-AVR / 46-ATC / 60-ATC-AVR -

RÉF. ART.	DESCRIPTION	LONGUEUR	REFERENCE FABRICANT
EL000365	BURIN POINTU TE-TP SM 27	L 270 MM	282286

BURIN POINTU TE-Y-RSM SDSMAX

HILTI



PERFO BURINEUR HILTI TE 60_PERFO BURINEUR HILTI TE 80

RÉF. ART.	DESCRIPTION	REFERENCE FABRICANT
EL105349	Burin pointu TE-Y-RSM SDSMAX 40 MP10 - UNITE	2232601
EL105350	Burin pointu TE-Y-RSM SDSMAX 40 MP5 - UNITE	2232608

photos non contractuelles

BURIN POUR MORTIERS

HILTI

PERFO BURINEUR MAKITA DHR243RMJV_PERFORATEUR
HILTI TE 30-A36 _PIQUEUR MAKITA HK 1820

RÉF. ART.	DESCRIPTION	LON- GUEUR	LAR- GEUR	REFERENCE FABRICANT
EL000374	BURIN POUR MORTIER TE-C SDS+ MM 1.2/18	L 180 MM	1 12 MM	204743

BURIN SPATULE POINTU TE-Y-SPI 50 SDS
MAX**HILTI**

PERFO BURINEUR HILTI TE 60_PERFO BURINEUR HILTI TE 80

RÉF. ART.	DESCRIPTION	REFERENCE FABRICANT
EL011095	BURIN SPATULE POINTU TE-Y-SPI 50 - SDS MAX	382278

BURIN SPATULE TE-SPX

HILTI

BURINEUR HILTI TE1000 BURINEUR HILTI TE2000

RÉF. ART.	DESCRIPTION	LONGUEUR	REFERENCE FABRICANT
EL018404	SPM 8/43	L 430 MM	2168882

BURIN SPATULE TE-CP SDS PLUS

HILTI

PERFO BURINEUR MAKITA DHR243RMJV_PERFORATEUR
HILTI TE 30-A36 _PIQUEUR MAKITA HK 1820

RÉF. ART.	DESCRIPTION	LON- GUEUR	LAR- GEUR	REFERENCE FAB- RICANT
EL000377	BURIN SPATULE TE-CP SPM 6/18 SDS+	L 180 MM	1 60 MM	282302
EL000378	BURIN SPATULE TE-CP SPME 8/18 SDS+	L 180 MM	1 80 MM	282306

photos non contractuelles

BURIN SPATULE/RACLOIR TE-CP

HILTI



PERFO BURINEUR MAKITA DHR243RMJV_PERFORATEUR
HILTI TE 30-A36 _PIQUEUR MAKITA HK 1820

RÉF. ART.	DESCRIPTION	LONGUEUR	LAR-GEUR	REFERENCE FABRI-CANT
EL000391	SPMK 8/18	L 180 MM	I 80 MM	282309
EL000392	SPMK 8/25	L 250 MM	I 80 MM	302754

BURIN TE-CP SDS PLUS

HILTI



PERFO BURINEUR MAKITA DHR243RMJV_PERFORATEUR
HILTI TE 30-A36 _PIQUEUR MAKITA HK 1820
Ensemble de burins SDS Plus (TE-C) avec conception polygonale pour une productivité maximale en démolition légère

RÉF. ART.	DESCRIPTION	LONGUEUR	REFERENCE FABRI-CANT
EL009820	BURIN TE-CP SM/FM 25 2 PLAT + 2 POINTU	L 250 MM	282311

BURIN SPATULE POINTU TE-S

HILTI



BURINEUR HILTI TE 1000
Burin à pelle en argile TE-S pour travaux de terrassement

RÉF. ART.	DESCRIPTION	LONGUEUR	LAR-GEUR	REFERENCE FABRI-CANT
EL010666	SPI50 BECHE	L 485 MM	I 115 MM	406785

BURIN TE-H28P

HILTI



BURINEUR HILTI TE3000

RÉF. ART.	DESCRIPTION	REFERENCE FABRICANT
EL018766	SM40-FM40- SPM8/40 JEU	2126925

photos non contractuelles

BURIN TE-SPX FM**HILTI**

BURINEUR HILTI TE1000 BURINEUR HILTI TE2000

RÉF. ART.	DESCRIPTION	LONGUEUR	REFERENCE FABRICANT
EL020461	70 BURIN PLAT	L 700 MM	2168877

BURIN TE-SPX SPM**HILTI**

BURINEUR HILTI TE 1000

RÉF. ART.	DESCRIPTION	LONGUEUR	REFERENCE FABRICANT
EL018770	12/36 BURIN SPATULE	L 360 MM	2168880
EL018771	12/43 BURIN SPATULE	L 430 MM	2168883
EL018772	12/50 BURIN SPATULE	L 500 MM	2168886
EL018773	5/36 BURIN SPATULE	L 360 MM	2168878
EL018774	5/43 BURIN SPATULE	L 430 MM	2168881
EL018775	5/50 BURIN SPATULE	L 500 MM	2168884
EL018776	8/36 BURIN SPATULE	L 360 MM	2168879
EL018777	8/50 BURIN SPATULE	L 500 MM	2168885

BURIN TE-SPX SM**HILTI**

BURINEUR HILTI TE1000 BURINEUR HILTI TE2000

RÉF. ART.	DESCRIPTION	LONGUEUR	REFERENCE FABRICANT
EL020462	36 BURIN POINTU	L 360 MM	2168870

BURIN TE-SPX SM-FM**HILTI**

BURINEUR HILTI TE1000 BURINEUR HILTI TE2000

RÉF. ART.	DESCRIPTION	LONGUEUR	REFERENCE FABRICANT
EL018767	36 JEU	L 360 MM	2168894
EL018768	36/50 JEU	L 360 MM	2168893
EL018769	50 JEU	L 500 MM	2168895

photos non contractuelles

BURIN TE-YPX - SDSMAX

HILTI



PERFO BURINEUR HILTI TE 60_PERFO BURINEUR HILTI TE 80

RÉF. ART.	DESCRIPTION	REFERENCE FABRICANT
EL105352	Burin TE-YPX - SDSMAX - FM 28 - UNITE	2241990
EL105354	Burin TE-YPX - SDSMAX - FM 36 - UNITE	2241995
EL105353	Burin TE-YPX - SDSMAX - FM 36 - UNITE	2241991
EL105748	Burin TE-YPX - SDSMAX - FM 50 - UNITE	2241994
EL105357	Burin TE-YPX - SDSMAX - FM 70 - UNITE	2241993
EL105358	Burin TE-YPX - SDSMAX - SM 28 - UNITE	2241982
EL105360	Burin TE-YPX - SDSMAX - SM 36 - UNITE	2241988
EL105363	Burin TE-YPX - SDSMAX - SM 50 - UNITE	2241987
EL105364	Burin TE-YPX - SDSMAX - SM 70 - UNITE	2241985
EL105366	Burin TE-YPX - SDSMAX - SM/FM 36 jeu - UNITE	2242012
EL105367	Burin TE-YPX - SDSMAX - SM/FM 36/50 jeu - LOT DE 4	2242011
EL105368	Burin TE-YPX - SDSMAX - SM/FM 50 jeu - LOT DE 10	2242013

COURONNE DE FORAGE TE-T

HILTI



PERFO BURINEUR HILTI TE 60_PERFO BURINEUR HILTI TE 80

RÉF. ART.	DESCRIPTION	DIAMETRE	REFERENCE FABRICANT
EL012580	-BK 68/26	D 68 MM	314252

COURONNE DE FORAGE TE-Y SDS MAX

HILTI

PERFO BURINEUR HILTI TE 60_PERFO BURINEUR HILTI TE 80
Couronne à percussion monobloc SDS max (TE-Y) pour perçage dans béton, maçonnerie et bloc sable-chaux

RÉF. ART.	DESCRIPTION	LON- GUEUR	DIAME- TRE	REFERENCE FABRICANT
EL009095	COURONNE DE FORAGE TE-Y BK 100/550- SDS MAX	L 550 MM	D 100 MM	2006313
EL010784	COURONNE DE FORAGE TE-Y BK 125/550 - SDS MAX		D 125 MM	2006314
EL009737	COURONNE DE FORAGE TE-Y BK 150/550- SDS MAX	L 550 MM	D 150 MM	2006315
EL008826	COURONNE DE FORAGE TE-Y BK 50/290- SDS MAX	L 290 MM	D 50 MM	2006303
EL008827	COURONNE DE FORAGE TE-Y BK 68/290- SDS MAX	L 290 MM	D 68 MM	2006307
EL008870	COURONNE DE FORAGE TE-Y-BK 45/550 - SDS MAX		D 45 MM	2006302
EL009045	COURONNE DE FORAGE TE-Y-BK 55/290- SDS MAX	L 290 MM	D 55 MM	2006305
EL009812	COURONNE DE FORAGE TE-Y-BK 55/550- SDS MAX	L 550 MM	D 55 MM	2006306
EL010819	COURONNE DE FORAGE TE-Y-BK 82/290 - SDS MAX		D 82 MM	2006309
EL009917	COURONNE DE FORAGE TE-Y-BK 82/550- SDS MAX	L 550 MM	D 82 MM	2006310
EL012584	COURONNE DE FORAGE TE-Y-BK 45/290 - SDS MAX		D 45 MM	2006301
EL012586	COURONNE DE FORAGE TE-Y-BK 50/550 - SDS MAX		D 50 MM	2006304
EL012588	COURONNE DE FORAGE TE-Y-BK 68/550 - SDS MAX		D 68 MM	2006308
EL012589	COURONNE DE FORAGE TE-Y-BK 90/290 - SDS MAX		D 90 MM	2006311
EL012590	COURONNE DE FORAGE TE-Y-BK 90/550 - SDS MAX	L 550 MM	D 90 MM	2006312

photos non contractuelles

GOUGE À ÉBAUCHER TE H28

HILTI

BURINEUR HILTI TE 3000

RÉF. ART.	DESCRIPTION	REFERENCE FABRICANT
EL019775	PD 20	2074312

GOUGE À ÉBAUCHER TE H29

HILTI

RÉF. ART.	DESCRIPTION	REFERENCE FABRICANT
EL019776	GOUGE À ÉBAUCHER TE H28 PD 25	2074313

GOUGE A RAINURER

HILTI

PERFO BURINEUR MAKITA DHR243RMJV_PERFORATEUR HILTI TE 30-A36 _PIQUEUR MAKITA HK 1820 Pour un rainurage efficace - Emmanchement SDS+ - Pour TE 2, TE 5, TE 6, TE 7, TE 15

RÉF. ART.	DESCRIPTION	LONGUEUR	LAR-GEUR	REFERENCE FABRI-CANT
EL002344	TE-C KM	L 250 MM	I 20 MM	30221
EL002348	TE-Y KMG 3.6X280 - SDS MAX	L 280 MM	I 36 MM	259563

MÈCHE A BUTEE HKD-TE-CX SDS +

HILTI

RÉF. ART.	DESCRIPTION	REFERENCE FABRICANT
EL014035	MÈCHE A BUTEE HKD-TE-CX-B M8X25 - SDS +	2097382

MECHE A BUTEE TE-C HSC-B - SDS+

HILTI



RÉF. ART.	DESCRIPTION	LON- GUEUR	DIAMETRE	REFERENCE FABRICANT
EL002858	MECHE A BUTEE TE-C HSC-B 14X40 - SDS+	L 40 MM	D 14 MM	31157
EL002859	MECHE A BUTEE TE-C HSC-B 14X50 - SDS+	L 50 MM	D 14 MM	31158
EL002860	MECHE A BUTEE TE-C HSC-B 16X40 - SDS+	L 40 MM	D 16 MM	28568
EL002863	MECHE A BUTEE TE-C HSC-B 20X60 - SDS+	L 60 MM	D 20 MM	30710

MECHE CAMPANULEE TE-C GB SDS+

HILTI



PERFO BURINEUR MAKITA DHR243RMJV_PERFORATEUR HILTI TE 30-A36 _PIQUEUR MAKITA HK 1820
Pour un forage performant - Emmanchement SDS Max - Pour TE 50 / 56 / 60 / 76 / 70 / 80

RÉF. ART.	DESCRIPTION	LON- GUEUR	DIAME- TRE	REFERENCE FABRICANT
EL002917	MECHE CAMPANULEE TE-C GB 32X45-1 1/4-SDS+	L 450 MM	D 32 MM	220630

MECHE A BUTEE TE-Y-HDA-B SDS MAX -

HILTI



Mèche à butée – nécessaire à l'installation des chevilles à verrouillage de forme HDA

RÉF. ART.	DESCRIPTION	LON- GUEUR	DIAMETRE	REFERENCE FABRICANT
EL009472	MECHE A BUTEE TE-Y-HDA-B 22X125- SDS MAX	L 125 MM	D 22 MM	402055
EL009473	MECHE A BUTEE TE-Y-HDA-B 30x190- SDS MAX	L 190 MM	D 30 MM	332097

photos non contractuelles

MECHE CAMPANULEE TE-Y GB SDS MAX

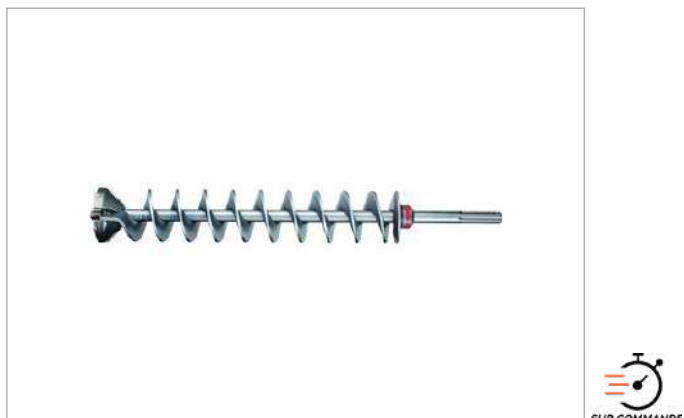
HILTI

PERFO BURINEUR MAKITA DHR243RMJV_PERFORATEUR
HILTI TE 30-A36_PIQUEUR MAKITA HK 1820
Pour un forage performant - Emmanchement SDS Max - Pour TE
50 / 56 / 60 / 76 / 70 / 81

RÉF. ART.	DESCRIPTION	LON- GUEUR	DIAME- TRE	REFERENCE FABRICANT
EL002919	MECHE CAMPANULEE TE-Y GB 45/59 1 3/4 - SDS MAX	L 590 MM	D 45 MM	220611
EL002920	MECHE CAMPANULEE TE-Y GB 45/92-1 3/4 - SDS MAX	L 920 MM	D 45 MM	220612
EL002921	MECHE CAMPANULEE TE-Y GB 55X592 - SDS MAX	L 590 MM	D 55 MM	28903
EL002922	MECHE CAMPANULEE TE-Y GB 55X922 - SDS MAX	L 920 MM	D 55 MM	28904
EL002923	MECHE CAMPANULEE TE-Y GB 66X59-2 1/2 - SDS MAX	L 590 MM	D 66 MM	28366
EL002924	MECHE CAMPANULEE TE-Y GB 66X92-2 1/2 - SDS MAX	L 920 MM	D 66 MM	28421
EL008813	MECHE CAMPANULEE TE-Y GB 80/63-3 1/8- SDS MAX	L 630 MM	D 80 MM	28367

MECHE CREUSE TE-CD SDS+

HILTI

PERFO BURINEUR MAKITA DHR243RMJV_PERFORATEUR
HILTI TE 2-A22_PERFORATEUR HILTI TE 30-A36_PERFORA-
TEUR HILTI TE 6-A36_PERFORATEUR SPIT 321_PERFORATEUR
SPIT 323

RÉF. ART.	DESCRIPTION	LON- GUEUR	DIAMETRE	REFERENCE FABRICANT
EL002925	MECHE CREUSE TE-CD 12/33 - SDS+	L 330 MM	D 12 MM	2018948
EL002926	MECHE CREUSE TE-CD 14/37 - SDS+	L 370 MM	D 14 MM	2018950
EL002927	MECHE CREUSE TE-CD 16/37 - SDS+	L 370 MM	D 16 MM	2018953
EL002928	MECHE CREUSE TE-CD 18/37 - SDS+	L 370 MM	D 18 MM	2018954

MECHE CREUSE TE-YD

HILTI

PERFO BURINEUR HILTI TE 60_PERFO BURINEUR HILTI TE
80_PERFO BURINEUR HILTI TE 700

RÉF. ART.	DESCRIPTION	LONGUEUR	DIAMETRE	REFERENCE FABRI- CANT
EL002929	16/59	L 590 MM	D 16 MM	2018967
EL002930	18/59	L 590 MM	D 18 MM	2018968
EL002931	20/59	L 590 MM	D 20 MM	2018970
EL002933	25/59	L 590 MM	D 25 MM	2018973
EL009029	25x900	L 890 MM	D 25 MM	2078876
EL009028	32x900	L 890 MM	D 32 MM	2078884

photos non contractuelles

MECHE DE CENTRAGE

HILTI



BURINEUR MAKITA HM1111C_PERFO BURINEUR HILTI TE 60_PERFO BURINEUR HILTI TE 80
Couronne à percussion monobloc SDS max (TE-Y) pour perçage dans béton, maçonnerie et bloc sable-chaux

RÉF. ART.	DESCRIPTION	LONGUEUR	REFERENCE FABRI-CANT
EL009933	TE-Y-BK10/13 KIT - SDS MAX	L 130 MM	2006300
EL002940	ZB3		62992

MÈCHE DE FORAGE TE-C - SDS+ STANDARD

HILTI



RÉF. ART.	DESCRIPTION	REFERENCE FABRI-CANT
EL105535	Mèche de forage TE-C - SDS+ - simple taillant - (6) M1 Set	2224211
EL105537	Mèche de forage TE-C - SDS+ - simple taillant - 10/16 MP32	2224276
EL105538	Mèche de forage TE-C - SDS+ - simple taillant - 10/16 MP8	2224242
EL105540	Mèche de forage TE-C - SDS+ - simple taillant - 10/21 MP32	2224277
EL105543	Mèche de forage TE-C - SDS+ - simple taillant - 10/31 MP8	2224244
EL105545	Mèche de forage TE-C - SDS+ - simple taillant - 12/16 MP32	2224278
EL105551	Mèche de forage TE-C - SDS+ - simple taillant - 12/31 MP8	2224295
EL105553	Mèche de forage TE-C - SDS+ - simple taillant - 14/16 MP8	2224247
EL105555	Mèche de forage TE-C - SDS+ - simple taillant - 14/21 MP8	2224297
EL105557	Mèche de forage TE-C - SDS+ - simple taillant - 14/31 MP8	2224298
EL105559	Mèche de forage TE-C - SDS+ - simple taillant - 16/16 MP8	2224300
EL105561	Mèche de forage TE-C - SDS+ - simple taillant - 16/21 MP8	2224301
EL105563	Mèche de forage TE-C - SDS+ - simple taillant - 16/31 MP8	2224302
EL105565	Mèche de forage TE-C - SDS+ - simple taillant - 4/11 MP8	2224238
EL105567	Mèche de forage TE-C - SDS+ - simple taillant - 5/11 MP32	2224199
EL105570	Mèche de forage TE-C - SDS+ - simple taillant - 5/16 MP32	2224200
EL105577	Mèche de forage TE-C - SDS+ - simple taillant - 6/11 MP32	2224201
EL105580	Mèche de forage TE-C - SDS+ - simple taillant - 6/16 MP32	2224202
EL105581	Mèche de forage TE-C - SDS+ - simple taillant - 6/16 MP8	2224283
EL105586	Mèche de forage TE-C - SDS+ - simple taillant - 6/31 MP8	2224285
EL105590	Mèche de forage TE-C - SDS+ - simple taillant - 8/11 MP32	2224274
EL105593	Mèche de forage TE-C - SDS+ - simple taillant - 8/16 MP32	2224275
EL105594	Mèche de forage TE-C - SDS+ - simple taillant - 8/16 MP8	2224291
EL105596	Mèche de forage TE-C - SDS+ - simple taillant - 8/21 MP32	2224205
EL105599	Mèche de forage TE-C - SDS+ - simple taillant - 8/31 MP8	2224293

photos non contractuelles

MECHE DE FORAGE TE-C3X SDS+

HILTI

PERFO BURINEUR MAKITA DHR243RMJV_PERFORATEUR
HILTI TE 2-A22_PERFORATEUR HILTI TE 30-A36_PERFORA-
TEUR HILTI TE 6-A36_PERFORATEUR SPIT 321_PERFORATEUR
SPIT 323

Foret spécial béton armé - Emmanchement SDS+ - Pour TE 2, TE
5, TE 6, TE 7, TE 15 -

RÉF. ART.	DESCRIPTION	LON- GUEUR	DIAMETRE	REFERENCE FABRICANT
EL002973	MECHE DE FORAGE TE- C3X 8X130 - SDS+	L 1300 MM	D 08 MM	2131027

MECHE DE FORAGE TECX SDS+

HILTI

PERFO BURINEUR MAKITA DHR243RMJV_PERFORATEUR
HILTI TE 2-A22_PERFORATEUR HILTI TE 30-A36_PERFORA-
TEUR HILTI TE 6-A36_PERFORATEUR SPIT 321_PERFORATEUR
SPIT 323

Foret spécial béton armé - Emmanchement SDS+ - Pour TE 2, TE
5, TE 6, TE 7, TE 15 -

RÉF. ART.	DESCRIPTION	LON- GUEUR	DIAME- TRE	REFERENCE FABRICANT
EL002977	MECHE DE FORAGE TE-CX - 4 TAILLANTS - 10/22 - SDS+	L 220 MM	D 10 MM	2022053
EL002979	MECHE DE FORAGE TECX - 4 TAILLANTS - 10/27 - SDS+	L 270 MM	D 10 MM	2022054
EL002980	MECHE DE FORAGE TECX - 4 TAILLANTS - 10/37 - SDS+	L 370 MM	D 10 MM	409191
EL002981	MECHE DE FORAGE TECX - 4 TAILLANTS - 10/47 - SDS+	L 470 MM	D 10 MM	409192
EL002982	MECHE DE FORAGE TECX - 4 TAILLANTS - 10/61 - SDS+	L 610 MM	D 10 MM	409193
EL019958	MÈCHE DE FORAGE TE-CX - 4 TAILLANTS - 10/90 - SDS+			2131028
EL002983	MECHE DE FORAGE TECX - 4 TAILLANTS - 11/22 - SDS+	L 220 MM	D 11 MM	409195
EL002984	MECHE DE FORAGE TECX - 4 TAILLANTS - 12/12 - SDS+	L 120 MM	D 12 MM	409196
EL017981	MECHE DE FORAGE TECX - 4 TAILLANTS - 12/1250MM - SDS +		D 12 MM	2131131
EL014131	MÈCHE DE FORAGE TE-CX - 4 TAILLANTS - 12/17 - SDS+	L 170 MM	D 12 MM	410121
EL002986	MECHE DE FORAGE TECX - 4 TAILLANTS - 12/22 - SDS+	L 220 MM	D 12 MM	2022056
EL002987	MECHE DE FORAGE TECX - 4 TAILLANTS - 12/27 - SDS+	L 270 MM	D 12 MM	2022014
EL002988	MECHE DE FORAGE TECX - 4 TAILLANTS - 12/47 - SDS+	L 470 MM	D 12 MM	409201
EL002989	MECHE DE FORAGE TECX - 4 TAILLANTS - 12/61 - SDS+	L 610 MM	D 12 MM	409202
EL019959	MÈCHE DE FORAGE TE-CX - 4 TAILLANTS - 12/90 - SDS+		D 12 MM	2131130
EL020551	MÈCHE DE FORAGE TE-CX - 4 TAILLANTS - 14/1260 MM		D 14 MM	2131133
EL002990	MECHE DE FORAGE TECX - 4 TAILLANTS - 14/17 - SDS+	L 170 MM	D 14 MM	2022016

photos non contractuelles

RÉFÉRENCE	ARTICLE	DESCRIPTION	LON- GUEUR	DIAME- TRE	
EL014139	MÈCHE DE FORAGE TE-CX - 4 TAILLANTS - 14/22			D 14 MM	409206
EL010370	MECHE DE FORAGE TECX - 4 TAILLANTS - 14/270-SDS+		L 270 MM	D 14 MM	2022018
EL002992	MECHE DE FORAGE TECX - 4 TAILLANTS - 14/470 - SDS+		L 470 MM	D 14 MM	409209
EL002993	MECHE DE FORAGE TECX - 4 TAILLANTS - 14-22 - SDS+		L 220 MM	D 14 MM	2022017
EL002994	MECHE DE FORAGE TECX - 4 TAILLANTS - 15/17 - SDS+		L 170 MM	D 15 MM	409211
EL002995	MECHE DE FORAGE TECX - 4 TAILLANTS - 15/27 - SDS+		L 270 MM	D 15 MM	409212
EL002996	MECHE DE FORAGE TECX - 4 TAILLANTS - 15/47 - SDS+		L 470 MM	D 15 MM	409213
EL020552	MÈCHE DE FORAGE TE-CX - 4 TAILLANTS - 16/1280 MM			D 16 MM	2131135
EL002997	MECHE DE FORAGE TECX - 4 TAILLANTS - 16/17 - SDS+		L 170 MM	D 16 MM	2022019
EL002998	MECHE DE FORAGE TECX - 4 TAILLANTS - 16/22 - SDS+		L 220 MM	D 16 MM	2022020
EL002999	MECHE DE FORAGE TECX - 4 TAILLANTS - 16/27 - SDS+		L 270 MM	D 16 MM	2022021
EL003000	MECHE DE FORAGE TECX - 4 TAILLANTS - 16/47 - SDS+		L 470 MM	D 16 MM	409217
EL003001	MECHE DE FORAGE TECX - 4 TAILLANTS - 16/61 - SDS+		L 610 MM	D 16 MM	409218
EL019961	MÈCHE DE FORAGE TE-CX - 4 TAILLANTS - 16/90 - SDS+				2131134
EL014144	MÈCHE DE FORAGE TE-CX - 4 TAILLANTS - 18/130 SDS+ - UNITE				2206750
EL105600	Mèche de forage TE-CX - 4 TAILLANTS - 18/22 - SDS+ - UNITE				2206745
EL009669	MECHE DE FORAGE TECX - 4 TAILLANTS - 18/32 - SDS+				2206746
EL105601	Mèche de forage TE-CX - 4 TAILLANTS - 18/48 - SDS+ - UNITE				2206747
EL105602	Mèche de forage TE-CX - 4 TAILLANTS - 18/61 - SDS+ - UNITE				2206748
EL105603	Mèche de forage TE-CX - 4 TAILLANTS - 18/90 - SDS+ - UNITE				2206749
EL105604	Mèche de forage TE-CX - 4 TAILLANTS - 20/22 - SDS+ - UNITE				2206751
EL003005	MECHE DE FORAGE TECX - 4 TAILLANTS - 20/48 - SDS+				2206618
EL014146	MÈCHE DE FORAGE TE-CX - 4 TAILLANTS - 20/610 - SDS+				2206752
EL105605	Mèche de forage TE-CX - 4 TAILLANTS - 24/27 - SDS+ - UNITE				2206731
EL105606	Mèche de forage TE-CX - 4 TAILLANTS - 24/62 - SDS+ - UNITE				2206732
EL105607	Mèche de forage TE-CX - 4 TAILLANTS - 25/27 - SDS+ - UNITE				2206733
EL105608	Mèche de forage TE-CX - 4 TAILLANTS - 28/48 - SDS+ - UNITE				2206738
EL003008	MECHE DE FORAGE TECX - 4 TAILLANTS - 5/12 - SDS+		L 120 MM	D 05 MM	2022041

RÉFÉRENCE	ARTICLE	DESCRIPTION	LON- GUEUR	DIAME- TRE	
EL003009	MECHE DE FORAGE TECX - 4 TAILLANTS - 5/15 - SDS+		L 150 MM	D 05 MM	2022042
EL014155	MÈCHE DE FORAGE TE-CX - 4 TAILLANTS - 5/17 - SDS+ - UNITE			D 05 MM	433786
EL014157	MÈCHE DE FORAGE TE-CX - 4 TAILLANTS - 5/22 - SDS+ - UNITE			D 05 MM	433787
EL003010	MECHE DE FORAGE TECX - 4 TAILLANTS - 6/12 - SDS+		L 120 MM	D 06 MM	2022044
EL003011	MECHE DE FORAGE TECX - 4 TAILLANTS - 6/17 - SDS+		L 170 MM	D 06 MM	2022045
EL003012	MECHE DE FORAGE TECX - 4 TAILLANTS - 6/22 - SDS+		L 220 MM	D 06 MM	2022046
EL003013	MECHE DE FORAGE TECX - 4 TAILLANTS - 6/27 - SDS+		L 270 MM	D 06 MM	433791
EL003014	MECHE DE FORAGE TECX - 4 TAILLANTS - 6/51 - SDS+		L 510 MM	D 06 MM	409173
EL003015	MECHE DE FORAGE TECX - 4 TAILLANTS - 7/17 - SDS+		L 170 MM	D 07 MM	409174
EL003016	MECHE DE FORAGE TECX - 4 TAILLANTS - 8/12 - SDS+		L 120 MM	D 08 MM	2022048
EL020553	MÈCHE DE FORAGE TE-CX - 4 TAILLANTS - 8/1300MM			D 08 MM	355475
EL003017	MECHE DE FORAGE TECX - 4 TAILLANTS - 8/17 - SDS+		L 170 MM	D 08 MM	2022049
EL003018	MECHE DE FORAGE TECX - 4 TAILLANTS - 8/22 - SDS+		L 220 MM	D 08 MM	2022050
EL003019	MECHE DE FORAGE TECX - 4 TAILLANTS - 8/27 - SDS+		L 270 MM	D 08 MM	2022051
EL003020	MECHE DE FORAGE TECX - 4 TAILLANTS - 8/32 - SDS+		L 320 MM	D 08 MM	409179
EL003021	MECHE DE FORAGE TECX - 4 TAILLANTS - 8/47 - SDS+		L 470 MM	D 08 MM	409181
EL003022	MECHE DE FORAGE TECX - 4 TAILLANTS - 8/61 - SDS+		L 610 MM	D 08 MM	409182
EL003023	MECHE DE FORAGE TECX - 4 TAILLANTS - 9/22 - SDS+		L 220 MM	D 09 MM	409186
EL002975	MECHE DE FORAGE TE-CX - 4 TAILLANTS - 10/13 - SDS+		L 120 MM	D 10 MM	409187
EL019960	MÈCHE DE FORAGE TE-CX - 4 TAILLANTS - 14/900 - SDS+			D 14 MM	2131132
EL100191	MÈCHE DE FORAGE TE-CX - 4 TAILLANTS - 22/27 - SDS+				2206619
EL100192	MÈCHE DE FORAGE TE-CX - 4 TAILLANTS - 22/48SDS+				2206730
EL920023	MÈCHE DE FORAGE TE-CX - 4 TAILLANTS - 28/27 SDS+				2206737
EL920011	MÈCHE DE FORAGE TE-CX - 4 TAILLANTS -25/48 SDS+				2206734
EL014123	MÈCHE DE FORAGE TE-CX (4) - 4 TAILLANTS - M10 - SDS +			D 10	2047741
EL002976	MECHE DE FORAGE TE-CX - 4 TAILLANTS - 10/17 - SDS+		L 170 MM	D 10 MM	2022052

photos non contractuelles

MECHE DE FORAGE TE-Y DS MAX

HILTI

PERFO BURINEUR HILTI TE 60_ PERFO BURINEUR HILTI TE 80_ PERFO BURINEUR HILTI TE 700
Foret spécial béton armé - Emmanchement SDS+ - Pour TE 2, TE 5, TE 6, TE 7, TE 15 -

RÉF. ART.	DESCRIPTION	LON- GUEUR	DIAME- TRE	REFERENCE FABRICANT
EL003068	MECHE DE FORAGE TE-Y 12/35 UTILE 200MM - SDS MAX	L 350 MM	D 12 MM	418301
EL003070	MECHE DE FORAGE TE-Y 14/35 UTILE 200MM - SDS MAX	L 350 MM	D 14 MM	418303
EL003071	MECHE DE FORAGE TE-Y 14/55 UTILE 400MM - SDS MAX	L 550 MM	D 14 MM	418304
EL003072	MECHE DE FORAGE TE-Y 15/35 UTILE 200MM - SDS MAX	L 350 MM	D 15 MM	418305
EL003073	MECHE DE FORAGE TE-Y 15/55 UTILE 400MM - SDS MAX	L 550 MM	D 15 MM	418306
EL003074	MECHE DE FORAGE TE-Y 16/35 UTILE 200MM - SDS MAX	L 350 MM	D 16 MM	418307
EL003075	MECHE DE FORAGE TE-Y 16/55 UTILE 400MM - SDS MAX	L 550 MM	D 16 MM	418308
EL003076	MECHE DE FORAGE TE-Y 18/32 UTILE 200MM - SDS MAX	L 320 MM	D 18 MM	418309
EL003077	MECHE DE FORAGE TE-Y 18/52 UTILE 400MM - SDS MAX	L 520 MM	D 18 MM	418310
EL003078	MECHE DE FORAGE TE-Y 20/32 UTILE 200MM - SDS MAX	L 320 MM	D 20 MM	418311
EL014184	MÈCHE DE FORAGE TE-Y 20/52 SDSMAX		D 20 MM	418312
EL003080	MECHE DE FORAGE TE-Y 22/52 UTILE 400MM - SDS MAX	L 520 MM	D 22 MM	418314
EL014185	MÈCHE DE FORAGE TE-Y 25/52 SDSMAX		D 25 MM	418318
EL003084	MECHE DE FORAGE TE-Y 26/28 UTILE 200MM - SDS MAX	L 280 MM	D 26 MM	418319
EL003085	MECHE DE FORAGE TE-Y 28/37 UTILE 200MM - SDS MAX	L 370 MM	D 28 MM	418320
EL003086	MECHE DE FORAGE TE-Y 28/57 UTILE 450MM - SDS MAX	L 570 MM	D 28 MM	418321
EL003089	MECHE DE FORAGE TE-Y 32/37 UTILE 200MM - SDS MAX	L 370 MM	D 32 MM	418324
EL003090	MECHE DE FORAGE TE-Y 32/57 UTILE 450MM - SDS MAX	L 570 MM	D 32 MM	418325

photos non contractuelles

RÉFÉRENCE ARTICLE	DESCRIPTION	LON- GUEUR	DIAME- TRE	
EL003091	MECHE DE FORAGE TE-Y 35/57 UTILE 450MM - SDS MAX	L 570 MM	D 35 MM	418326
EL003092	MECHE DE FORAGE TE-Y 37/37 UTILE 200MM - SDS MAX	L 370 MM	D 37 MM	418327
EL003094	MECHE DE FORAGE TE-Y 40/57 UTILE 450MM - SDS MAX	L 570 MM	D 40 MM	418329

MECHE DE FORAGE TE-YX

HILTI

PERFO BURINEUR HILTI TE 60_ PERFO BURINEUR HILTI TE 80_ PERFO BURINEUR HILTI TE 700
Mèche haute performance TE-Y (SDSmax), une durée de vie supérieure et moins de vibrations - Emmanchement SDS Max - Pour TE 50 / 56 / 60 / 76 / 70 / 80 -

RÉF. ART.	DESCRIPTION	LON- GUEUR	DIAMETRE	REFERENCE FAB- RICANT
EL003095	- SDSMAX - 4 TAILLANTS 12X35	L 350 MM	D 12 MM	206499
EL003096	- SDSMAX - 4 TAILLANTS 12X55	L 550 MM	D 12 MM	206500
EL003097	- SDSMAX - 4 TAILLANTS 12X67	L 670 MM	D 12 MM	206501
EL009069	- SDSMAX - 4 TAILLANTS 12X92	L 920 MM	D 12 MM	355467
EL003098	- SDSMAX - 4 TAILLANTS 14X35 -	L 350 MM	D 14 MM	206502
EL003099	- SDSMAX - 4 TAILLANTS 14X55	L 550 MM	D 14 MM	206503

MÈCHE DE FORAGE TE-YX

HILTI

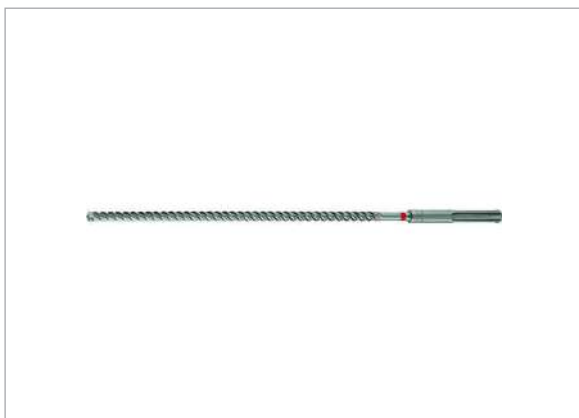

PERFO BURINEUR HILTI TE 60_ PERFO BURINEUR HILTI TE 80_ PERFO BURINEUR HILTI TE 700
Mèche haute performance TE-Y (SDSmax), une durée de vie supérieure et moins de vibrations - Emmanchement SDS Max - Pour TE 50 / 56 / 60 / 76 / 70 / 80 -

RÉF. ART.	DESCRIPTION	REFERENCE FABRICANT
EL014200	- SDSMAX - 4 TAILLANTS 15/130	355472
EL014201	- SDSMAX - 4 TAILLANTS 15/92	355471

MECHE DE FORAGE TE-YX

HILTI



PERFO BURINEUR HILTI TE 60_ PERFO BURINEUR HILTI TE 80_ PERFO BURINEUR HILTI TE 700
Mèche haute performance TE-Y (SDSmax), une durée de vie supérieure et moins de vibrations - Emmanchement SDS Max - Pour TE 50 / 56 / 60 / 76 / 70 / 80 -

RÉF. ART.	DESCRIPTION	LON- GUEUR	DIAMETRE	REFERENCE FAB- RICANT
EL003100	- SDSMAX - 4 TAILLANTS 15X35	L 350 MM	D 15 MM	206504
EL009085	- SDSMAX - 4 TAILLANTS 16/130	L 1300 MM	D 16 MM	355473
EL003102	- SDSMAX - 4 TAILLANTS 16/92	L 920 MM	D 16 MM	206508
EL003103	- SDSMAX - 4 TAILLANTS 16X35	L 350 MM	D 16 MM	206506
EL009753	- SDSMAX - 4 TAILLANTS 16X67	L 670 MM	D 16 MM	421907
EL003105	- SDSMAX - 4 TAILLANTS 18/1300	L 1300 MM	D 18 MM	293140

MÈCHE DE FORAGE TE-YX SDS MAX

HILTI



PERFO BURINEUR HILTI TE 60_ PERFO BURINEUR HILTI TE 80_ PERFO BURINEUR HILTI TE 700
Mèche à percussion SDS max (TE-Y) avec tête de carbure, 4 arêtes de coupe et hélice à 4 cannelures pour le forage en béton armé

RÉF. ART.	DESCRIPTION	LON- GUEUR	DIAMETRE	REFERENCE FABRICANT
EL014198	MÈCHE DE FORAGE TE-YX 14/130 - 4 TAILLANTS - SDS MAX			355470
EL014199	MÈCHE DE FORAGE TE-YX 14/92 - 4 TAILLANTS - SDS MAX			355469
EL017699	MECHE DE FORAGE TE-YX 18/32 SDS MAX 4 TAILLANTS			2122291
EL017700	MECHE DE FORAGE TE-YX 18/52 SDS MAX 4 TAILLANTS			2122293
EL003108	MECHE DE FORAGE TE-YX 18/72 4 TAILLANTS SDSMAX	L 720 MM	D 18 MM	427845
EL003109	MECHE DE FORAGE TE-YX 18/92 4 TAILLANTS SDSMAX	L 920 MM	D 18 MM	293054
EL003110	MECHE DE FORAGE TE-YX 20/130 4 TAILLANTS SDSMAX	L 1300 MM	D 20 MM	293148
EL017701	MECHE DE FORAGE TE-YX 20/32 SDS MAX 4 TAILLANTS			2122296
EL017702	MECHE DE FORAGE TE-YX 20/52 SDS MAX 4 TAILLANTS			2122298
EL009073	MECHE DE FORAGE TE-YX 20/72 4 TAILLANTS SDSMAX	L 720 MM	D 20 MM	427846
EL003113	MECHE DE FORAGE TE-YX 20/92 4 TAILLANTS SDSMAX	L 920 MM	D 20 MM	293143
EL003114	MECHE DE FORAGE TE-YX 22/130 4 TAILLANTS SDSMAX	L 1300 MM	D 22 MM	293180
EL017703	MECHE DE FORAGE TE-YX 22/32 4 TAILLANTS - SDS MAX			2122301
EL017704	MECHE DE FORAGE TE-YX 22/52 4 TAILLANTS - SDS MAX			2122303
EL010369	MECHE DE FORAGE TE-YX 22/72 4 TAILLANTS - SDS MAX	L 720 MM	D 22 MM	427847
EL003117	MECHE DE FORAGE TE-YX 22/920 4 TAILLANTS - SDS MAX	L 920 MM	D 22 MM	293177
EL017705	MECHE DE FORAGE TE-YX 24/32 - SDS MAX4 TAILLANTS			2122217

photos non contractuelles

RÉFÉRENCE	ARTICLE	DESCRIPTION	LON- GUEUR	DIAME- TRE	
EL017706		MECHE DE FORAGE TE-YX 24/42 - SDS MAX 4 TAILLANTS			2122219
EL003120		MECHE DE FORAGE TE-YX 25/130 - SDS MAX 4 TAILLANTS	L 1300 MM	D 25 MM	293230
EL017707		MECHE DE FORAGE TE-YX 25/32 - SDS MAX 4 TAILLANTS		D 25 MM	2122275
EL017708		MECHE DE FORAGE TE-YX 25/52 - SDS MAX 4 TAILLANTS		D 25 MM	2122277
EL003123		MECHE DE FORAGE TE-YX 25/92 - SDS MAX 4 TAILLANTS	L 920 MM	D 25 MM	293229
EL003125		MECHE DE FORAGE TE-YX 28/130 - SDS MAX 4 TAILLANTS	L 1300 MM	D 28 MM	293238
EL017710		MECHE DE FORAGE TE-YX 28/32 - SDSMAX - 4 TAILLANTS		D 28 MM	2122279
EL017711		MECHE DE FORAGE TE-YX 28/52 - SDSMAX - 4 TAILLANTS		D 28 MM	2122281
EL003127		MECHE DE FORAGE TE-YX 28/92 - SDSMAX - 4 TAILLANTS	L 920 MM	D 28 MM	293236
EL003129		MECHE DE FORAGE TE-YX 30/130 - SDSMAX - 4 TAILLANTS	L 1300 MM	D 30 MM	293286
EL017712		MECHE DE FORAGE TE-YX 30/37 - SDSMAX - 4 TAILLANTS			2122282
EL017713		MECHE DE FORAGE TE-YX 30/57 - SDSMAX - 4 TAILLANTS			2122283
EL017714		MECHE DE FORAGE TE-YX 30/92 - SDSMAX - 4 TAILLANTS			293259
EL003132		MECHE DE FORAGE TE-YX 32/130 - SDSMAX - 4 TAILLANTS	L 1300 MM	D 32 MM	293411
EL017715		MECHE DE FORAGE TE-YX 32/37 - SDSMAX - 4 TAILLANTS			2122284
EL017716		MECHE DE FORAGE TE-YX 32/57 - SDSMAX - 4 TAILLANTS			2122286
EL003135		MECHE DE FORAGE TE-YX 32/92 - SDSMAX - 4 TAILLANTS	L 920 MM	D 32 MM	293410
EL017717		MECHE DE FORAGE TE-YX 35/57 - SDSMAX - 4 TAILLANTS			2120338
EL017718		MECHE DE FORAGE TE-YX 37/130 - SDSMAX - 4 TAILLANTS			2120423
EL017719		MECHE DE FORAGE TE-YX 37/37 - SDSMAX - 4 TAILLANTS			2120420
EL017720		MECHE DE FORAGE TE-YX 37/57 - SDSMAX - 4 TAILLANTS			2120424
EL017721		MECHE DE FORAGE TE-YX 37/920 - SDSMAX - 4 TAILLANTS			2120422
EL017722		MECHE DE FORAGE TE-YX 40/37 - SDSMAX - 4 TAILLANTS			2120425
EL017723		MECHE DE FORAGE TE-YX 40/57 - SDSMAX - 4 TAILLANTS			2120428
EL017800		MECHE DE FORAGE TE-YX 40/57 - SDSMAX - 4 TAILLANTS		D 40 MM	2120427
EL017724		MECHE DE FORAGE TE-YX 40/92 - SDSMAX - 4 TAILLANTS			2120426
EL017725		MECHE DE FORAGE TE-YX 45/57 - SDSMAX - 4 TAILLANTS			2120430

photos non contractuelles

RÉFÉRENCE	ARTICLE	DESCRIPTION	LON- GUEUR	DIAME- TRE	
EL017726		MECHE DE FORAGE TE-YX 45/920 - SDSMAX - 4 TAILLANTS			2120429
EL017727		MECHE DE FORAGE TE-YX 55/57 - SDSMAX - 4 TAILLANTS			2120431
EL017728		MECHE DE FORAGE TE-YX 55/92 - SDSMAX - 4 TAILLANTS			2120432

OUTIL DE POSE CONDUCT TERRE TP-TKS

HILTI



BURINEUR HILTI TE 1000

Tête universelle pour tige de terre pour utilisation avec la tige SDS Max (TE-Y) et TE-S

RÉF. ART.	DESCRIPTION	LONGUEUR	LAR- GEUR	EPAIS- SEUR	REFERENCE FAB- RICANT
EL009087	25	L 72 MM	146 MM	H 46 MM	436073

PLAQUE RACLAGE TE-H28 STP

HILTI



Emmanchement Hex 28 mm pour marteaux pneumatiques 30 Kg

RÉF. ART.	DESCRIPTION	LONGUEUR	LAR- GEUR	REFERENCE FABRI- CANT
EL003596	200X200	L 200 MM	1200 MM	47782

RALLONGE DE MECHE TE-FY-

HILTI

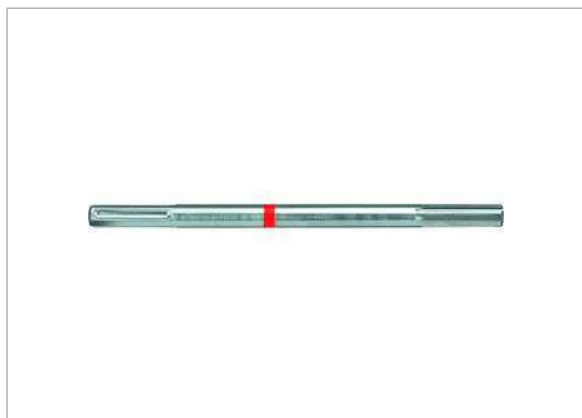

PERFO BURINEUR HILTI TE 80

Efficace dans le trou de forage à béton et la maçonnerie

RÉF. ART.	DESCRIPTION	LONGUEUR	DIAMETRE	REFERENCE FABRICANT
EL003852	E 60 - SDS MAX	L 600 MM	D 18 MM	1953
EL003853	E35 - SDS MAX	L 350 MM	D 18 MM	1952
EL003854	E85 - SDS MAX	L 850 MM	D 18 MM	1954

SET M1 TE-CX PANACHEES

HILTI



PERFO BURINEUR MAKITA DHR243RMJV_PERFORATEUR
HILTI TE 2-A22_PERFORATEUR HILTI TE 30-A36_PERFORA-
TEUR HILTI TE 6-A36_PERFORATEUR SPIT 321_PERFORATEUR
SPIT 323

Lot de mèches beton ferrailé - 1*6 - 1

RÉF. ART.	DESCRIPTION	REFERENCE FABRICANT
EL004114	LOT DE 6 - SDS+	411214

SET L2 TE-CX PANACHEES

HILTI



PERFO BURINEUR MAKITA DHR243RMJV_PERFORATEUR
HILTI TE 2-A22_PERFORATEUR HILTI TE 30-A36_PERFORA-
TEUR HILTI TE 6-A36_PERFORATEUR SPIT 321_PERFORATEUR
SPIT 323

Lot de mèches beton ferrailé - 1*12 - 1

RÉF. ART.	DESCRIPTION	DIAMETRE	REFERENCE FABRICANT
EL004113	LOT DE 12- SDS+	D 12 MM	411216

TIGE UNIVERSELLE TE

HILTI



BURINEUR HILTI TE 1000

Tige universelle TE-S pour différentes têtes

RÉF. ART.	DESCRIPTION	LONGUEUR	REFERENCE FABRICANT
EL009086	TIGE UNIVERSELLE TE-S SS450 MP32	L 450 MM	406786
EL004498	TIGE UNIVERSELLE TE-H28 SS 40	L 400 MM	47779

photos non contractuelles

ADAPTATEUR SDS MAX VERS SDS+

MAKITA



PERFO BURINEUR HILTI TE 60_PERFO BURINEUR HILTI TE 80
ADAPTATEUR SDS-MAX => SDS+

RÉF. ART.

EL010496

BURIN LARGE SDS MAX

MAKITA



PERFO BURINEUR HILTI TE 60_PERFO BURINEUR HILTI TE 80
BURINEUR MAKITA HM1111C
BURIN LARGE SDS-MAX 50X400MM

RÉF. ART.	DESCRIPTION	LONGUEUR	LARGEUR
EL010493	L.400MM L.50MM	L 400 MM	I 50 MM

BURIN COUDÉ SDS+

MAKITA



PERFORATEUR HILTI TE 30-A36_PIQUEUR MAKITA HK 1820
- SP_PIQUEUR MAKITA HK1820L_PERFO BURINEUR DHR-
243RMJV
BURIN COUDE SDS+ 40X200MM

RÉF. ART.	DESCRIPTION	LONGUEUR	LARGEUR
EL010499	L.200MM I.40MM	L 200 MM	I 40 MM
EL010500	L.250MM L.60MM	L 250 MM	I 60 MM

BURIN LARGE SDS+

MAKITA



PERFORATEUR HILTI TE 30-A36_PIQUEUR MAKITA HK 1820
- SP_PIQUEUR MAKITA HK1820L_PERFO BURINEUR DHR-
243RMJV
BURIN LARGE SDS+ 40X250MM

RÉF. ART.	DESCRIPTION	LONGUEUR	LARGEUR
EL010487	L.250MM I.40MM	L 250 MM	I 40 MM
EL010498	L.250MM I.60MM	L 250 MM	I 60 MM

photos non contractuelles

BURIN PLAT SDS MAX

MAKITA



PERFO BURINEUR HILTI TE 60_BURINEUR HILTI TE 80_BURINEUR MAKITA HM1111C
BURIN PLAT SDS-MAX 280MM

RÉF. ART.	DESCRIPTION	LONGUEUR	LARGEUR
EL010491	L.280MM	L 280 MM	
EL010492	L.400MM L.25MM	L 400 MM	1 25 MM

COFFRET 2 PICS 3 BURINS SDS+

MAKITA



PERFORATEUR HILTI TE 30-A36_PIQUEUR MAKITA HK 1820
- SP_PIQUEUR MAKITA HK1820L_PERFO BURINEUR DHR-243RMJV
COFFRET 2 PICS 3 BURINS SDS+

RÉF. ART.
EL010489

BURIN PLAT SDS+

MAKITA



PERFORATEUR HILTI TE 30-A36_PIQUEUR MAKITA HK 1820
- SP_PIQUEUR MAKITA HK1820L_PERFO BURINEUR DHR-243RMJV
BURIN PLAT SDS+ 20X250MM

RÉF. ART.	DESCRIPTION	LONGUEUR	LARGEUR
EL010486	L.250MM I.20MM	L 250 MM	1 20 MM

COFFRET 5 FORETS NEMESIS SDS+

MAKITA



PERFORATEUR HILTI TE 6-A36_PERFORATEUR HILTI TE 30-A36_PERFORATEUR HILTI TE 2-A22_PERFORATEUR SPIT 321_PERFORATEUR SPIT 323_PERFORATEUR HILTI TE 2-M_PERFO BURINEUR DHR243RMJV

RÉF. ART.	DESCRIPTION
EL008734	1D5,2D6,1D8,1D10

photos non contractuelles

DOSETTE D'HUILE PNEUMATIQUE

POUR OUTILLAGE PNEUMATIQUE



RÉF. ART.

CO005035

FORET BÉTON NEMESIS SDS

MAKITA



PERFO BURINEUR HILTI TE 60_PERFO BURINEUR HILTI TE 80
4 TAILLANTS

RÉF. ART.	DESCRIPTION	LONGUEUR	DIAMETRE
EL008735	MAX USAGE OCCASIONNEL D.12MM L.340MM	L 340 MM	D 12 MM

FORET BÉTON NEMESIS SDS MAX

MAKITA



PERFO BURINEUR HILTI TE 60_PERFO BURINEUR HILTI TE 80
4 TAILLANTS

RÉF. ART.	DESCRIPTION	LONGUEUR	DIAMETRE
EL008736	USAGE OCCASIONNEL D.14MM L.340MM	L 340 MM	D 14 MM
EL008737	USAGE OCCASIONNEL D.15MM L.340MM	L 340 MM	D 15 MM
EL008738	USAGE OCCASIONNEL D.16MM L.340MM	L 340 MM	D 16 MM
EL008739	USAGE OCCASIONNEL D.16MM L.540MM	L 340 MM	D 16 MM
EL008740	USAGE OCCASIONNEL D.18MM L.340MM	L 340 MM	D 18 MM
EL008741	USAGE OCCASIONNEL D.18MM L.540MM	L 540 MM	D 18 MM
EL008742	USAGE OCCASIONNEL D.18MM L.940MM	L 940 MM	D 18 MM
EL008743	USAGE OCCASIONNEL D.20MM L.320MM	L 320 MM	D 20 MM
EL008744	USAGE OCCASIONNEL D.22MM L.320MM	L 320 MM	D 22 MM
EL008745	USAGE OCCASIONNEL D.22MM L.920MM	L 920 MM	D 22 MM
EL008746	USAGE OCCASIONNEL D.24MM L.320MM	L 320 MM	D 24 MM
EL008748	USAGE OCCASIONNEL D.24MM L.520MM	L 520 MM	D 24 MM
EL008747	USAGE OCCASIONNEL D.25MM L.320MM	L 320 MM	D 25 MM
EL008749	USAGE OCCASIONNEL D.25MM L.920MM	L 920 MM	D 25 MM
EL008750	USAGE OCCASIONNEL D.26MM L.520MM	L 520 MM	D 26 MM
EL008751	USAGE OCCASIONNEL D.28MM L.370MM	L 370 MM	D 28 MM
EL008752	USAGE OCCASIONNEL D.28MM L.670MM	L 670 MM	D 28 MM
EL008753	USAGE OCCASIONNEL D.30MM L.370MM	L 370 MM	D 30 MM
EL008754	USAGE OCCASIONNEL D.30MM L.570MM	L 570 MM	D 30 MM
EL008755	USAGE OCCASIONNEL D.32MM L.370MM	L 370 MM	D 32 MM
EL008756	USAGE OCCASIONNEL D.32MM L.570MM	L 570 MM	D 32 MM
EL008757	USAGE OCCASIONNEL D.32MM L.920MM	L 920 MM	D 32 MM
EL008758	USAGE OCCASIONNEL D.35MM L.370MM	L 370 MM	D 35 MM
EL008759	USAGE OCCASIONNEL D.35MM L.570MM	L 570 MM	D 35 MM
EL008761	USAGE OCCASIONNEL D.40MM L.370MM	L 370 MM	D 40 MM
EL008762	USAGE OCCASIONNEL D.40MM L.920MM	L 920 MM	D 40 MM
EL008763	USAGE OCCASIONNEL D.45MM L.570MM	L 570 MM	D 45 MM

photos non contractuelles

FORET BÉTON NEMESIS SDS+

MAKITA



PERFORATEUR HILTI TE 6-A36_PERFORATEUR HILTI TE 30-A36_PERFORATEUR HILTI TE 2-A22_PERFORATEUR SPIT 321_PERFORATEUR SPIT 323_PERFORATEUR HILTI TE 2-M_PERFO BURINEUR DHR243RMJV
4 TAILLANTS

RÉF. ART.	DESCRIPTION	LONGUEUR	DIAMETRE
EL008700	USAGE OCCASIONNEL D.5MM L.110MM	L 110 MM	D 5 MM
EL008704	USAGE OCCASIONNEL D.6,5MM L.160MM	L 160 MM	D 6,5 MM
EL008701	USAGE OCCASIONNEL D.6MM L.10MM	L 100 MM	D 6 MM
EL008702	USAGE OCCASIONNEL D.6MM L.160MM	L 160 MM	D 6 MM
EL008703	USAGE OCCASIONNEL D.6MM L.210MM	L 210 MM	D 6 MM
EL008705	USAGE OCCASIONNEL D.7MM L.110MM	L 110 MM	D 7 MM
EL008706	USAGE OCCASIONNEL D.8MM L.110MM	L 110 MM	D 8 MM
EL008707	USAGE OCCASIONNEL D.8MM L.160MM	L 160 MM	D 8 MM
EL008708	USAGE OCCASIONNEL D.8MM L.210MM	L 210 MM	D 8 MM
EL008709	USAGE OCCASIONNEL D.8MM L.260MM	L 260 MM	D 8 MM
EL008711	USAGE OCCASIONNEL D.10MM L.110M	L 110 MM	D 10 MM
EL008712	USAGE OCCASIONNEL D.10MM L.160M	L 160 MM	D 10 MM
EL008713	USAGE OCCASIONNEL D.10MM L.210M	L 210 MM	D 10 MM
EL008714	USAGE OCCASIONNEL D.10MM L.260M	L 260 MM	D 10 MM
EL008715	USAGE OCCASIONNEL D.10MM L.450M	L 450 MM	D 10 MM
EL008716	USAGE OCCASIONNEL D.10MM L.600M	L 600 MM	D 10 MM
EL008717	USAGE OCCASIONNEL D.12MM L.160M	L 160 MM	D 12 MM
EL008718	USAGE OCCASIONNEL D.12MM L.210M	L 210 MM	D 12 MM
EL008719	USAGE OCCASIONNEL D.12MM L.260M	L 260 MM	D 12 MM
EL008720	USAGE OCCASIONNEL D.12MM L.450M	L 450 MM	D 12 MM
EL008721	USAGE OCCASIONNEL D.12MM L.600M	L 600 MM	D 12 MM
EL008722	USAGE OCCASIONNEL D.14MM L.160M	L 160 MM	D 14 MM
EL008723	USAGE OCCASIONNEL D.14MM L.210M	L 210 MM	D 14 MM
EL008724	USAGE OCCASIONNEL D.14MM L.260M	L 260 MM	D 14 MM
EL008725	USAGE OCCASIONNEL D.14MM L.450M	L 450 MM	D 14 MM

»			
RÉFÉRENCE ARTICLE	DESCRIPTION	LONGUEUR	DIAMETRE
EL008726	USAGE OCCASIONNEL D.14MM L.600MM	L 600 MM	D 14 MM
EL008727	USAGE OCCASIONNEL D.15MM L.160M	L 160 MM	D 15 MM
EL008728	USAGE OCCASIONNEL D.15MM L.210M	L 210 MM	D 15 MM
EL008733	USAGE OCCASIONNEL D.15MM L.450M	L 450 MM	D 15 MM
EL008729	USAGE OCCASIONNEL D.16MM L.160M	L 160 MM	D 16 MM
EL008730	USAGE OCCASIONNEL D.16MM L.260M	L 260 MM	D 16 MM
EL008731	USAGE OCCASIONNEL D.16MM L.450M	L 450 MM	D 16 MM
EL008732	USAGE OCCASIONNEL D.16MM L.600M	L 600 MM	D 16 MM

photos non contractuelles

FORET SDS - BOSCH



USAGE INTENSIF -Tête carbure 4 taillants

RÉF. ART.	DESCRIPTION
EL100686	plus-7X D.5MM L.110MM
EL100690	plus-7XD.6,5MM L.160MM
EL100687	plus-7XD.6MM L.100MM
EL100688	plus-7XD.6MM L.160MM
EL100689	plus-7XD.6MM L.210MM
EL100744	plus-7XD.7MM L.110MM
EL100745	plus-7XD.8MM L.110MM
EL100746	plus-7XD.8MM L.160MM
EL100747	plus-7XD.8MM L.210MM
EL100748	plus-7XD.8MM L.260MM
EL100749	plus-7XD.10MM L.110MM
EL100750	plus-7XD.10MM L.160MM
EL100751	plus-7XD.10MM L.210MM
EL100752	plus-7XD.10MM L.260MM
EL100753	plus-7XD.10MM L.450MM
EL100754	plus-7XD.10MM L.600MM
EL100755	plus-7XD.12MM L.160MM
EL100756	plus-7XD.12MM L.210MM
EL100757	plus-7XD.12MM L.260MM
EL100772	plus-7XD.12MM L.340MM
EL100758	plus-7XD.12MM L.450MM
EL100759	plus-7XD.12MM L.600MM
EL100760	plus-7XD.14MM L.160MM
EL100761	plus-7XD.14MM L.210MM
EL100762	plus-7XD.14MM L.260MM
EL100773	plus-7XD.14MM L.340MM
EL100763	plus-7XD.14MM L.450MM
EL100764	plus-7XD.14MM L.600MM
EL100765	plus-7XD.15MM L.160MM
EL100766	plus-7XD.15MM L.210MM
EL100771	plus-7XD.15MM L.450MM
EL100767	plus-7XD.16MM L.160MM
EL100768	plus-7XD.16MM L.260MM
EL100774	plus-7XD.16MM L.340MM
EL100769	plus-7XD.16MM L.450MM
EL100775	plus-7XD.16MM L.540MM
EL100770	plus-7XD.16MM L.600MM
EL100776	plus-7XD.18MM L.340MM
EL100777	plus-7XD.18MM L.540MM
EL100778	plus-7XD.18MM L.940MM
EL100779	plus-7XD.20MM L.320MM
EL100780	plus-7XD.22MM L.320MM
EL100781	plus-7XD.22MM L.920MM
EL100782	plus-7XD.24MM L.320MM
EL100784	plus-7XD.24MM L.520MM
EL100783	plus-7XD.25MM L.320MM
EL100785	plus-7XD.25MM L.920MM
EL100786	plus-7XD.26MM L.520MM
EL100787	plus-7XD.28MM L.370MM
EL100788	plus-7XD.28MM L.670MM
EL100789	plus-7XD.30MM L.370MM
EL100790	plus-7XD.30MM L.570MM
EL100791	plus-7XD.32MM L.370MM
EL100792	plus-7XD.32MM L.570MM
EL100793	plus-7XD.32MM L.920MM
EL100794	plus-7XD.35MM L.570MM
EL100795	plus-7XD.40MM L.920MM
EL100796	plus-7XD.45MM L.570MM

photos non contractuelles

HUILE POUR PERFORATEUR
PNEUMATIQUE 2L

POUR OUTILLAGE PNEUMATIQUE



RÉF. ART.	DESCRIPTION
CO005154	(SPEC. ROULEMENT)

POINTEROLLE SDS+

MAKITA



PERFORATEUR HILTI TE 30-A36_PIQUEUR MAKITA HK 1820
- SP_PIQUEUR MAKITA HK1820L_PERFO BURINEUR DHR-
243RMJV

POINTEROLLE SDS+ 250MM

RÉF. ART.	DESCRIPTION
EL010485	L.250MM

ADAPTATEUR FORET S2S MAX

spit

PERFO BURINEUR HILTI TE 60_PERFO BURINEUR HILTI TE 80_BURINEUR MAKITA HM1111C
POUR PERCER EN SDS+ AVEC SPIT 352 SVC - 1

RÉF. ART.	REFERENCE FABRICANT
EL007079	112010

ALLONGE TURBO KIT L280

spit

PERFO BURINEUR HILTI TE 60_PERFO BURINEUR HILTI TE 80 SDS MAX

RÉF. ART.	REFERENCE FABRICANT
EL007982	113810

ADAPTATEUR TURBO KIT SDS MAX

spit

PERFO BURINEUR HILTI TE 60_PERFO BURINEUR HILTI TE 80 SDS MAX

RÉF. ART.	REFERENCE FABRICANT
EL007981	112000

AXE FILETE TURBO KIT

spit

PERFO BURINEUR HILTI TE 60_PERFO BURINEUR HILTI TE 80_BURINEUR MAKITA HM1111C SDS MAX

RÉF. ART.	REFERENCE FABRICANT
EL007093	113880

photos non contractuelles

BOUCHARDE CARBURE

spit

PERFO BURINEUR HILTI TE 60_PERFO BURINEUR HILTI TE 80_BURINEUR MAKITA HM1111C
SDS MAX

RÉF. ART.	DESCRIPTION	REFERENCE FABRICANT
EL006988	16 DENTS	62740
EL006989	25 DENTS	62750
EL006987	9 DENTS	62730

BURIN LG 400 S2S MAX LG 25 *

spit

PERFO BURINEUR HILTI TE 60_PERFO BURINEUR HILTI TE 80_BURINEUR MAKITA HM1111C
SDS MAX

RÉF. ART.	LONGUEUR	LARGEUR	REFERENCE FABRICANT
EL007085	L 400 MM	I 25 MM	112220

BURIN HEX SDS+ L.250 POUR 431 ET 335

*

spit

PERFORATEUR HILTI TE 30-A36_PIQUEUR MAKITA HK 1820 - SP_PIQUEUR MAKITA HK1820L_PERFO BURINEUR DHR-243RMJV
SDS MAX

RÉF. ART.	LONGUEUR	REFERENCE FABRICANT
EL007253	L 250 MM	223050

BURIN MAX LG 540 LG 25 *

spit

PERFO BURINEUR HILTI TE 60_PERFO BURINEUR HILTI TE 80_BURINEUR MAKITA HM1111C
SDS MAX

RÉF. ART.	LONGUEUR	LARGEUR	REFERENCE FABRICANT
EL007086	L 540 MM	I 25 MM	112230

photos non contractuelles

FORET R FORCE3



PERFORATEUR HILTI TE 6-A36_PERFORATEUR HILTI TE 30-A36_PERFORATEUR HILTI TE 2-A22_PERFORATEUR SPIT 321_PERFORATEUR SPIT 323_PERFORATEUR HILTI TE 2-S_PERFO BURINEUR DHR243RMJV SDS+

RÉF. ART.	DESCRIPTION	LONGUEUR	DIAMETRE	REFERENCE FABRICANT
EL006602	Ø 08/260/200 *	L 260 MM	D 08 MM	225364
EL006607	Ø 10/260/200 *	L 260 MM	D 10 MM	225370
EL006619	Ø 14/310/250 *	L 310 MM	D 14 MM	225383

FORET R FORCE3+



PERFORATEUR HILTI TE 6-A36_PERFORATEUR HILTI TE 30-A36_PERFORATEUR SPIT 321_PERFORATEUR SPIT 323_PERFORATEUR HILTI TE 2-S_PERFO BURINEUR DHR243RMJV SDS+

RÉF. ART.	DESCRIPTION	LONGUEUR	DIAMETRE	REFERENCE FABRICANT
EL006573	Ø 16/300/250	L 300 MM	D 16 MM	225420
EL006576	Ø 18/250/200	L 250 MM	D 18 MM	54029
EL006578	Ø 20/250/200	L 250 MM	D 20 MM	54031
EL006580	Ø 20/600/550*	L 600 MM	D 20 MM	54033
EL006579	Ø 20X450-400 *	L 450 MM	D 20 MM	54032
EL006582	Ø 22/450/400*	L 450 MM	D 22 MM	54035
EL006583	Ø 24/250/200*	L 250 MM	D 24 MM	54036
EL006589	Ø 26/450/400 *	L 450 MM	D 26 MM	54042

FORET R3 MAX



PERFO BURINEUR HILTI TE 60_PERFO BURINEUR HILTI TE 80 SDS MAX

RÉF. ART.	DESCRIPTION	LON- GUEUR	DIAMETRE	REFERENCE FAB- RICANT
EL007301	D.16X540X400	L 540 MM	D 16 MM	225100
EL007307	D.20X320X200	L 320 MM	D 20 MM	225106
EL007308	D.20X520X400	L 520 MM	D 20 MM	225107
EL007309	D.20X920X800	L 920 MM	D 20 MM	225108
EL007310	D.22X320X200	L 320 MM	D 22 MM	225109
EL007311	D.22X520X400	L 520 MM	D 22 MM	225110
EL007312	D.22X920X800	L 920 MM	D 22 MM	225111
EL007313	D.24X320X200	L 320 MM	D 24 MM	225112
EL007314	D.24X520X400	L 520 MM	D 24 MM	225113
EL007317	D.25X1320X1200	L 1320 MM	D 25 MM	225116
EL007315	D.25X520X400	L 520 MM	D 25 MM	225114
EL007316	D.25X920X800	L 920 MM	D 25 MM	225115
EL007318	D.26X520X400	L 520 MM	D 26 MM	225117
EL007319	D.28X520X400	L 520 MM	D 28 MM	225118
EL007320	D.28X920X800	L 920 MM	D 28 MM	225119
EL007322	D.30X520X400	L 520 MM	D 30 MM	225121
EL007325	D.32X1320X1200	L 1320 MM	D 32 MM	225125
EL007323	D.32X520X400	L 520 MM	D 32 MM	225123
EL007324	D.32X920X800	L 920 MM	D 32 MM	225124
EL007326	D.35X320X200 jusqu'à épauement	L 320 MM	D 35 MM	225126
EL007327	D.35X520X400	L 520 MM	D 35 MM	225127
EL007328	D.35X720X600	L 720 MM	D 35 MM	225128
EL007330	D.38X520X400	L 520 MM	D 38 MM	225130
EL007331	D.40X520X400	L 520 MM	D 40 MM	225131
EL007332	D.40X920X800	L 920 MM	D 40 MM	225132
EL007333	D.42X520X400	L 520 MM	D 42 MM	225133
EL007334	D.45X520X400	L 520 MM	D 45 MM	225134
EL007335	D.50X520X400	L 520 MM	D 50 MM	225135

photos non contractuelles

FORET XT3 MAX

spit



PERFO BURINEUR HILTI TE 60_PERFO BURINEUR HILTI TE 80 SDS MAX

RÉF. ART.	DESCRIPTION	LONGUEUR	DIAMETRE	REFERENCE FABRI-CANT
EL007295	D.12X340X200	L 340 MM	D 12 MM	225094
EL007297	D.14X340X200	L 340 MM	D 14 MM	225096
EL007298	D.14X540X400	L 540 MM		225097
EL007299	D.15X340X200	L 340 MM	D 15 MM	225098
EL007300	D.16X340X200	L 340 MM	D 16 MM	225099
EL007302	D.16X670X600	L 740 MM		225101
EL007303	D.18X340X200	L 340 MM	D 18 MM	225102
EL007304	D.18X540X400	L 540 MM	D 18 MM	225103
EL007305	D.18X740X600	L 740 MM	D 18 MM	225104
EL007306	D.18X940X800	L 940 MM	D 18 MM	225105

FORET XT3 SDS

spit



PERFORATEUR HILTI TE 6-A36_PERFORATEUR HILTI TE 30-A36_PERFORATEUR HILTI TE 2-A22_PERFORATEUR SPIT 321_PERFORATEUR SPIT 323_PERFORATEUR HILTI TE 2-S_PERFO BURINEUR DHR243RMJV SDS+ PREMIUM

RÉF. ART.	DESCRIPTION	LON-GUEUR	DIAMETRE	REFERENCE FABRI-CANT
EL007270	D.10X110X50 * jusqu'à épuisement	L 110 MM	D 10 MM	224736
EL007271	D.10X160X100 *	L 160 MM	D 10 MM	224737
EL007272	D.10X210X150 *	L 210 MM	D 10 MM	224738
EL007273	D.10X260X200 *	L 260 MM	D 10 MM	224739
EL007274	D.10X310X250 *	L 310 MM	D 10 MM	224740
EL007275	D.10X450X400 *	L 450 MM	D 10 MM	224741
EL007276	D.10X600X550 *	L 600 MM	D 10 MM	224742
EL007277	D.12X160X100 *	L 160 MM	D 12 MM	224743
EL007278	D.12X210X150 *	L 210 MM	D 12 MM	224744
EL007279	D.12X260X200 *	L 260 MM	D 12 MM	224745
EL007280	D.12X310X250 *	L 310 MM	D 12 MM	224746
EL007281	D.12X450X400 *	L 450 MM	D 12 MM	224747
EL007282	D.12X600X550 *	L 600 MM	D 12 MM	224748
EL007283	D.14X160X100 *	L 160 MM	D 14 MM	224749
EL007284	D.14X210X150 *	L 210 MM	D 14 MM	224750
EL007285	D.14X260X200 *	L 260 MM	D 14 MM	224751
EL007286	D.14X310X250 *	L 310 MM	D 14 MM	224752
EL007287	D.14X450X400 *	L 450 MM	D 14 MM	224753
EL007288	D.14X600X550 *	L 600 MM	D 14 MM	224754
EL007289	D.16X200X150 *	L 200 MM	D 16 MM	224755
EL007290	D.16X250X250 *	L 250 MM	D 16 MM	224756
EL007291	D.16X300X250 *	L 300 MM	D 16 MM	224757
EL007292	D.16X450X400	L 450 MM	D 16 MM	224758
EL007293	D.16X600X550	L 600 MM	D 16 MM	224759
EL007259	D.5X160X100 *	L 160 MM	D 05 MM	224718
EL007264	D.6.5X210X150 *	L 210 MM	D 06 MM	224727
EL007260	D.6X110X50	L 110 MM	D 06 MM	224721
EL007261	D.6X160X100 *	L 160 MM	D 06 MM	224722
EL007262	D.6X210X150 *	L 210 MM	D 06 MM	224723
EL007263	D.6X260X200 *	L 260 MM	D 06 MM	224724
EL007265	D.8X110X50	L 110 MM	D 08 MM	224730
EL007266	D.8X160X100 *	L 160 MM	D 08 MM	224731
EL007267	D.8X210X150 *	L 210 MM	D 08 MM	224732
EL007268	D.8X310X250 *	L 310 MM	D 08 MM	224734
EL007269	D.8X450X400 *	L 450 MM	D 08 MM	224735
EL007258	D.5X100X50 *	L 100 MM	D 05 MM	224717

photos non contractuelles

PELLE COUD SDS+



PERFORATEUR HILTI TE 30-A36_PIQUEUR MAKITA HK 1820
- SP_PIQUEUR MAKITA HK1820L_PERFO BURINEUR DHR-
243RMJV
SDS+

RÉF. ART.	DESCRIPTION	LONGUEUR	LAR- GEUR	REFERENCE FABRI- CANT
EL007256	L.165 LG 75 *	L 165 MM	I 75 MM	223054
EL007255	L.250 LG 40 * jusqu'à épauement	L 250 MM	I 40 MM	223053

PELLE PLATE SDS+



PERFORATEUR HILTI TE 30-A36_PIQUEUR MAKITA HK 1820
- SP_PIQUEUR MAKITA HK1820L_PERFO BURINEUR DHR-
243RMJV
SDS+

RÉF. ART.	DESCRIPTION	LONGUEUR	LAR- GEUR	REFERENCE FABRI- CANT
EL007254	L.250 LG40 *	L 250 MM	I 40 MM	223051

PELLE MAX

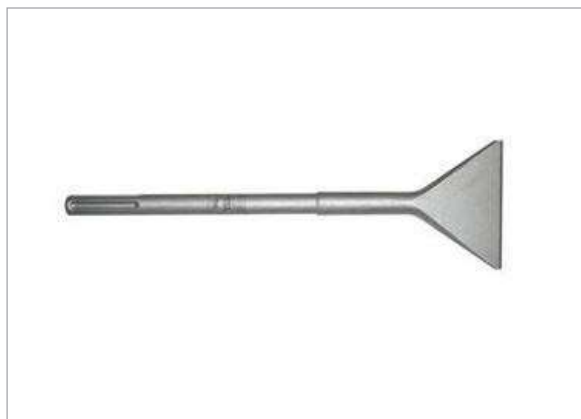

PERFO BURINEUR HILTI TE 60_PERFO BURINEUR HILTI TE
80_BURINEUR MAKITA HM1111C
SDS MAX

RÉF. ART.	DESCRIPTION	LONGUEUR	LAR- GEUR	REFERENCE FABRI- CANT
EL007088	LG 350 LG 110*	L 350 MM	I 110 MM	112250

PIC HEX SDS+



PERFORATEUR HILTI TE 30-A36_PIQUEUR MAKITA HK 1820
- SP_PIQUEUR MAKITA HK1820L_PERFO BURINEUR DHR-
243RMJV
SDS+

RÉF. ART.	DESCRIPTION	LONGUEUR	REFERENCE FABRICANT
EL007252	L.250 POUR 431 ET 335 *	L 250 MM	223049

photos non contractuelles

PIC LG 400 S2S MAX ***spit**

PERFO BURINEUR HILTI TE 60_PERFO BURINEUR HILTI TE 80_BURINEUR MAKITA HM1111C
SDS MAX

RÉF. ART.	LONGUEUR	REFERENCE FABRICANT
EL007082	L 400 MM	112200

PORTE BOUCHARDE CARBURE MAX**spit**

PERFO BURINEUR HILTI TE 60_PERFO BURINEUR HILTI TE 80_BURINEUR MAKITA HM1111C
SDS MAX

RÉF. ART.	REFERENCE FABRICANT
EL007090	112290

PIC MAX LG 540 ***spit**

PERFO BURINEUR HILTI TE 60_PERFO BURINEUR HILTI TE 80_BURINEUR MAKITA HM1111C
SDS MAX

RÉF. ART.	LONGUEUR	REFERENCE FABRICANT
EL007084	L 540 MM	112210

TARIERE BOIS S2S**spit**

PERFORATEUR HILTI TE 6-A36_PERFORATEUR HILTI TE 30-A36_PERFORATEUR SPIT 321_PERFORATEUR SPIT 323_PERFORATEUR HILTI TE 2-S_PERFO BURINEUR DHR243RMJV
SDS+

RÉF. ART.	DESCRIPTION	LONGUEUR	DIAMETRE	REFERENCE FABRICANT
EL007213	Ø16/400/320	L 400 MM	D 16 MM	195120
EL007212	Ø 14 400X320 SPIT	L 400 MM	D 14 MM	195110
EL007210	Ø10X300X220	L 300 MM	D 10 MM	195090
EL007211	Ø12X400X320	L 400 MM	D 12 MM	195100
EL007214	Ø18/400/320	L 400 MM	D 18 MM	195130
EL007216	Ø22/400/320	L 400 MM	D 22 MM	195150
EL007217	Ø24/400/320	L 400 MM	D 24 MM	195160
EL007218	Ø26/400/320	L 400 MM	D 26 MM	195170
EL007215	Ø20/400/320	L 400 MM	D 20 MM	195140

photos non contractuelles

TREPAN MACON



SDS+

RÉF. ART.	DESCRIPTION	DIAMETRE	REFERENCE FABRICANT
EL007076	. M.16 D.66	D 66 MM	110910

TREPAN TURBO KIT



SDS MAX

RÉF. ART.	DESCRIPTION	DIAMETRE	REFERENCE FABRICANT
EL007257	D.105	D 105 MM	223209
EL007075	D.125	D 125 MM	110830
EL007072	D.65	D 65 MM	110780
EL007073	D.80	D 80 MM	110800
EL007074	D.90	D 90 MM	110810

photos non contractuelles

PONCEUSE DIAMANT DG 150

HILTI



we
life
b
DISTRIPUS

RÉF. ART.	DESCRIPTION	REFERENCE FABRICANT
EL020012	DLX 230V	2056618

PONCEUSE DIAMANT DGH 130

HILTI



we
life
b
DISTRIPUS

Meuleuse béton pour un ponçage léger et la finition des surfaces murales et des sols Diamètre de la meule: 130 mm Poids selon la norme EPTA 01/2003 (donnée): 2.54 kg Matériau support: Béton, Ciment

RÉF. ART.	DESCRIPTION	REFERENCE FABRICANT
EL018493	230V DLX	2267003

SET DISC DGH 130 DISQUE DE FINITION

HILTI



LASER ROTATIF HILTI PR 2_LASER ROTATIF HILTI PR 3_AUTRE LASER ROTATIF HILTI

RÉF. ART.	REFERENCE FABRICANT
OU018637	435441

LIME À BANDE FEIN BF 10-280 E (avec 1 bras 3/6mm)



we
life
b
DISTRIPUS

Lime à bande endroits difficiles d'accès - Largeur de bande : 3, 6 ou 20 mm - 800 W - 2,1 kg - Possibilité de faire du polissage

RÉF. ART.
EL020162

photos non contractuelles

LIME À BANDE FEIN FILAIRE



+ bandes abrasives https://fein.com/fr_fr/machines/poncage-et-polissage/acier-inoxydable/lime-a-bande/bf-10-280-e-set-72280551000/

RÉF. ART.	DESCRIPTION	REFERENCE FABRICANT
EL104713	- BF10-280 E SET PRO (avec 3 bras)	BF10-280E SET PRO

PONCEUSE A BANDE POUR TUBES FEIN RS 12-70E



Diamètre 8 à 80 mm - 1200 W - 3,8 kg - **Formation renforcée obligatoire**

RÉF. ART.
EL020161

PONCEUSE A BANDE MAKITA 9403J

MAKITA

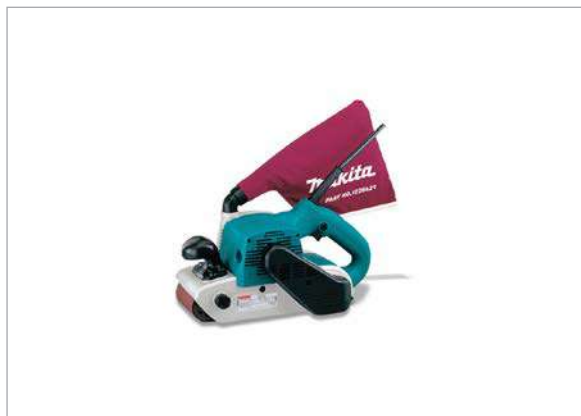

[1200 W - 230 V - 100x610 mm - 5,7 kg]

RÉF. ART.
EL005332

PONCEUSE EXCENTRIQUE BO6030J

MAKITA



[310 W - 230 V - D.150 mm - 2,4 kg]

RÉF. ART.
EL005335

photos non contractuelles

**PONCEUSE EXCENTRIQUE FILAIRE
BO5041J 300W D.125 MM**

MAKITA



Filaire - 300W - Ø125

RÉF. ART.
EL008689

**PONCEUSE EXCENTRIQUE SUR BATTERIE
MAKITA DB0180 RTJ**

MAKITA



Ponçage finition tous matériaux - Aspiration des poussières intégrée - Ø125 - 18 V - 5Ah - 1,7 kg

RÉF. ART.
EL018392

PONCEUSE PLAFOND SUR CHARIOT

IETS



RÉF. ART.	DESCRIPTION	REFERENCE FABRICANT
EL920028	XB165 MARGUERITE SANS DISQUE	PON100312

SIGNIFICATION DISTRIPPLUS & WE LOVE LIFE



RÉF. ART.
PICTOS

PLATEAU DE PONCAGE W-AFE

HILTI

SCIE SAUTEUSE HILTI WSJ 850

Accessoires pour meuleuses roto-orbitales WFE

RÉF. ART.	DESCRIPTION	DIAMETRE	REFERENCE FABRICANT
EL003627	DVS ENS	D 150 MM	326043
EL003628	DVU ENS	D 150 MM	339782
EL003629	DVW ENS	D 150 MM	339783

SEMELLE DE PONCAGE

HILTI

PONCEUSE HILTI WFO 280

Accessoires pour meuleuses orbitales WFO

RÉF. ART.	DESCRIPTION	REFERENCE FABRICANT
EL004082	W-AFO PV	331702

DÉCAPEUR POUR HK1820L

MAKITA

 we
life

 DISTRIPUS

PIQUEUR MAKITA HK1820L

DÉCAPEUR POUR HK1820L SDS+ 100MM

RÉF. ART.	DESCRIPTION
EL010455	SDS+ D.100MM jusqu'à épuisement

PLATEAU SOUPLE AUTO-AGRIPPANT POUR PONCEUSE BO6030

MAKITA



PONCEUSE MAKITA BO6030J

PLATEAU AUTO-AGRIPPANT SOUPLE Ø150 POUR PONCEUSE BO6030

RÉF. ART.	DESCRIPTION
EL010448	D.150MM

COFFRET VARIATEUR D165 IP 20 POTENTIOMETRE POUR PONCEUSE FOUINE XB165

IETS

RÉF. ART.	REFERENCE FABRICANT
EL920030	VAR100353

photos non contractuelles

ELAND CHARIOT INTER POUR PONCEUSE FOUINE XB165

IETS

RÉF. ART.	REFERENCE FABRICANT
EL920031	CPO100404

BRAS DE PONCAGE PLAFOND POUR PONCEUSE XB165

IETS



RÉF. ART.	REFERENCE FABRICANT
EL920032	BPO100450E

PLATEAU DE PONCAGE DIAM 165 LONGEVITE POUR PONCEUSE PLAFOND SUR CHARIOT

IETS



RÉF. ART.	DESCRIPTION	REFERENCE FABRICANT
EL920029	XB165 (VENDU A L'UNITÉ)	MDSM-165

COFFRET VARIATEUR D165 - IP65 POTENTIOMETRE

IETS

RÉF. ART.	REFERENCE FABRICANT
EL101019	VAR100355

photos non contractuelles

PLATEAU DE PONCAGE DIAM 165 MDSMA POUR PONCEUSE PLAFOND SUR CHARIOT

IETS

RÉF. ART.	DESCRIPTION	REFERENCE FABRICANT
EL104624	XB165	MDSMA

DISQUE PENTASURF D.125 BETON TOUS TRAVAUX

SPIT



SURFACEUSE SPIT SG125E

RÉF. ART.	DIAMETRE	REFERENCE FABRICANT
EL007593	D 125 MM	610516

DISQUE PENTASURF D.125 SPECIAL REVETEMENT

SPIT



RÉF. ART.	REFERENCE FABRICANT
EL007595	610518

DISQUE PENTASURF D.125 BETON TRAVAUX DE DEGROSSISSAGE

SPIT

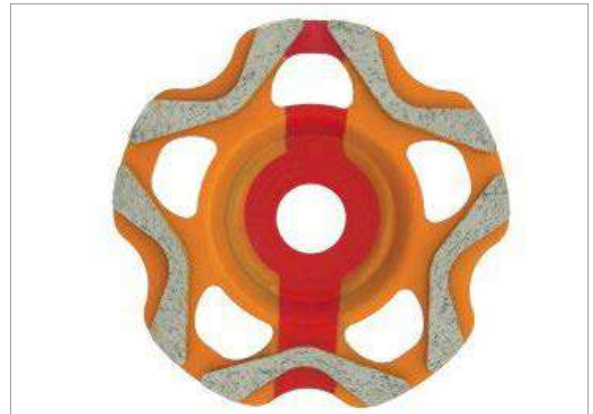
SURFACEUSE SPIT SG125E
POUR MATERIAUX DURS 1 RANGE DE SEGMENTS - 1

RÉF. ART.	DIAMETRE	REFERENCE FABRICANT
EL007592	D 125 MM	610515

DISQUE PENTASURF D.125 BETON TRAVAUX DE FINITION

SPIT

SURFACEUSE SPIT SG125E
POUR TOUS MATERIAUX - 1

RÉF. ART.	DIAMETRE	REFERENCE FABRICANT
EL007594	D 125 MM	610517

photos non contractuelles

**DISQUE PENTASURF D.125 MAT.
ABRASIFS TOUS TRAVAUX**

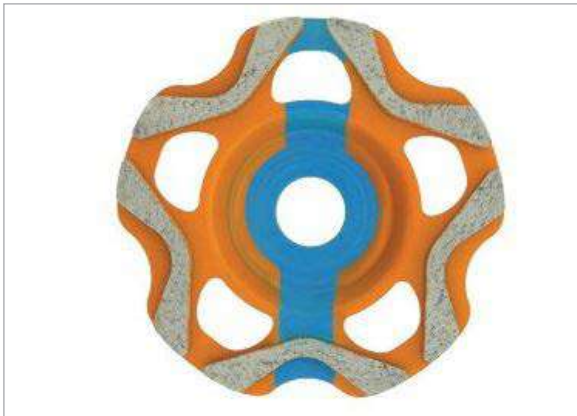

SURFACEUSE SPIT SG125E
POUR MATERIAUX ABRASIFS 2 RANGEES DE SEGMENTS - 1

RÉF. ART.	DIAMETRE	REFERENCE FABRICANT
EL007596	D 125 MM	610519

DISQUE SILVER TURBO T D.230



MEULEUSE HILTI DCG 230-DB
Disque pour tuiles - 1

RÉF. ART.	DIAMETRE	REFERENCE FABRICANT
EL007571	D 230 MM	610039

DISQUE SILVER MULTIMAT D.230



MEULEUSE HILTI DCG 230-DB

RÉF. ART.	DIAMETRE	REFERENCE FABRICANT
EL007587	D 230 MM	610214

DIAMOND CUP 150/



RÉF. ART.	DESCRIPTION	REFERENCE FABRICANT
EL019750	6 SPX UNIV	2163567

photos non contractuelles

DISQUE FINITION BÉTON 130

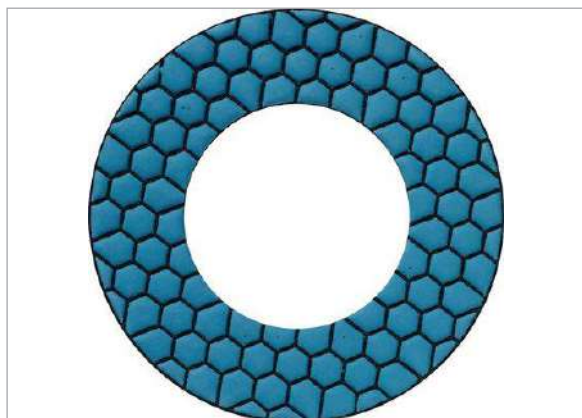
HILTI

RÉF. ART.	DESCRIPTION	REFERENCE FABRICANT
EL019751	DISQ. FINIT. BÉTON 130 SPX (30) G.100	2207456

DISQUE FINITION BÉTON 132

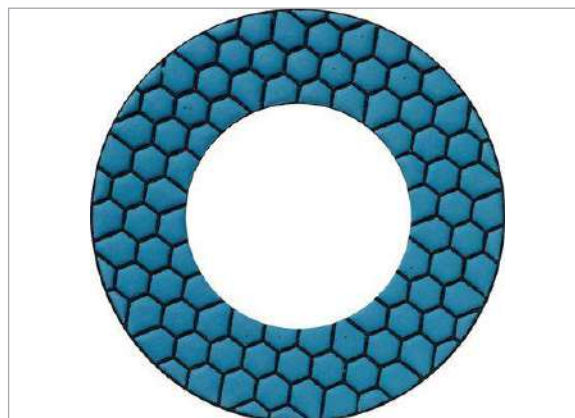
HILTI

RÉF. ART.	DESCRIPTION	REFERENCE FABRICANT
EL019752	DISQ. FINIT. BÉTON 130 SPX G.100 vendu au lot 6	2207452

DISQUE FINITION BÉTON 131

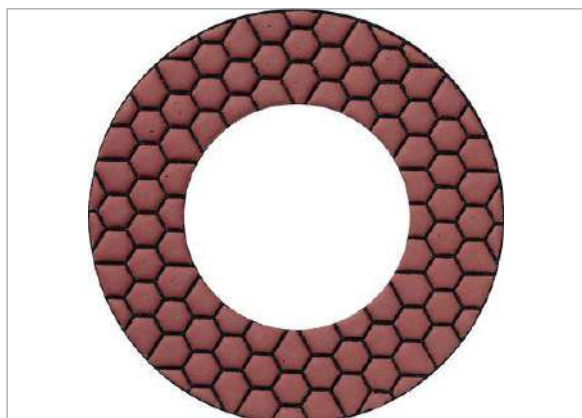
HILTI

RÉF. ART.	DESCRIPTION	REFERENCE FABRICANT
EL019753	DISQ. FINIT. BÉTON 130 SPX (30) G.50	2207451

DISQUE FINITION BÉTON 133

HILTI

RÉF. ART.	DESCRIPTION	REFERENCE FABRICANT
EL019754	DISQ. FINIT. BÉTON 130 SPX SPX G.200 (LOT DE 30)	2207455

photos non contractuelles

MEULE AU DIAMANT DG



RÉF. ART.	DESCRIPTION	REFERENCE FABRICANT
EL017927	-CW 150/6 SPX ABRAS POUR BETON JEUNES	2163728

MEULE DIAMANT 150/6'''



RÉF. ART.	DESCRIPTION	REFERENCE FABRICANT
EL018103	SP® UNIVERSEL	2163733
EL018104	SPX® EPOXY PC	2163726

MEULE AU DIAMANT SPX



RÉF. ART.	DESCRIPTION	REFERENCE FABRICANT
EL017903	150/6 FINITION SOIGNE	2163722
EL017936	150/6 POUR DG 150	2163568

MEULE DIAMANT DG-CW 125/



RÉF. ART.	DESCRIPTION	REFERENCE FABRICANT
EL100421	5 SP UNIV	2238568

photos non contractuelles

PAPIER ABRASIF BOIS W-CFE

HILTI



SCIE SAUTEUSE HILTI WSJ 850

Abratif pour le ponçage du bois - - 50 - 50

RÉF. ART.	DESCRIPTION	LONGUEUR	DIAMETRE	REFERENCE FAB- RICANT
EL003380	150-VW P100 LOT DE 50	L 50 MM	D 150 MM	315732
EL003381	150-VW P120 LOT DE 50	L 50 MM	D 150 MM	315733
EL003382	150-VW P150 LOT DE 50	L 50 MM	D 150 MM	315735
EL003383	150-VW P180 LOT DE 50	L 50 MM	D 150 MM	315737
CO003384	150-VW P60 LOT DE 50		D 150 MM	315730
CO003385	150-VW P80 LOT DE 50		D 150 MM	315731

PAPIER ABRASIF PEINTURE W-CFE

HILTI

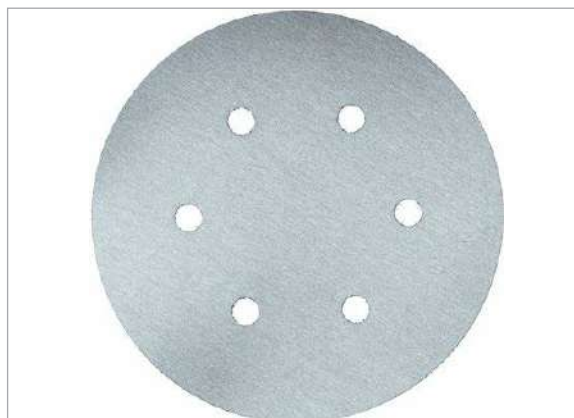

SCIE SAUTEUSE HILTI WSJ 850

Abratif pour le ponçage de peinture - - 50 - 50

RÉF. ART.	DESCRIPTION	LONGUEUR	DIAMETRE	REFERENCE FAB- RICANT
EL003392	150-VP P100 LOT DE 50	L 50 MM	D 150 MM	315745
EL003393	150-VP P120 LOT DE 50	L 50 MM	D 150 MM	315746
EL003394	150-VP P180 LOT DE 50	L 50 MM	D 150 MM	315750
EL003395	150-VP P220 LOT DE 50	L 50 MM	D 150 MM	315752
EL003397	150-VP P40 LOT DE 50	L 50 MM	D 150 MM	315742
EL003398	150-VP P60 LOT DE 50	L 50 MM	D 150 MM	315743
EL003399	150-VP P80 LOT DE 50	L 50 MM	D 150 MM	315744

PAPIER ABRASIF BOIS W-CFO

HILTI

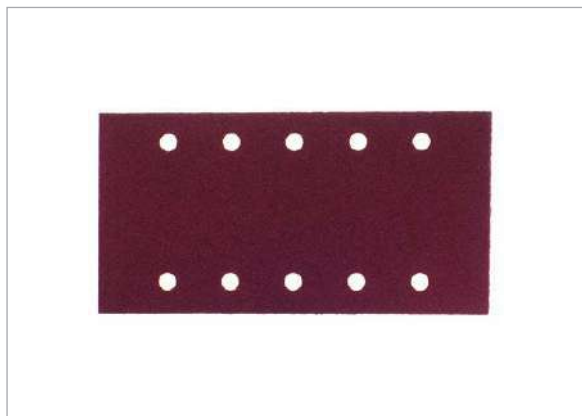

PONCEUSE HILTI WFO 280

Abratif pour le ponçage du bois - - 50 - 50

RÉF. ART.	DESCRIPTION	LONGUEUR	REFERENCE FABRICANT
EL003387	280-VW P120 LOT DE 50	L 280 MM	315766
EL003388	280-VW P150 LOT DE 50	L 280 MM	315768
EL003389	280-VW P180 LOT DE 50	L 280 MM	315770
CO003390	280-VW P60 LOT DE 50	L 280 MM	315763
CO003391	280-VW P80 LOT DE 50 3	L 280 MM	315764

PAPIER ABRASIF PEINTURE W-CFO

HILTI



PONCEUSE HILTI WFO 280

Abratif pour le ponçage du bois - - 50 - 50

RÉF. ART.	DESCRIPTION	LONGUEUR	REFERENCE FABRICANT
EL003402	280-VP P220 LOT DE 50	L 280 MM	315785
EL003404	280-VP P60 LOT DE 50 X2	L 280 MM	315776

photos non contractuelles

PAPIER ABRASIF W-CFE

HILTI



SCIE SAUTEUSE HILTI WSJ 850
Abratif pour le ponçage du bois - - 50 - 50

RÉF. ART.	DESCRIPTION	DIAMETRE	REFERENCE FABRICANT
EL003406	JEU DE 100	D 150 MM	335643

BANDE ABRASIVE CERAMIQUE

PFERD

MEULEUSE DROITE FEIN GCZ8-280PEL_MEULEUSE DROITE
FEIN GCZ18-280LBL
BA 20/520 CO-COOL 120 (VENDU PAR 20)

RÉF. ART.	DESCRIPTION
EL020337	(VENDU PAR 20)
EL020334	BA 20/520 CO-COOL 40 (VENDU PAR 20)
EL020335	BA 20/520 CO-COOL 60 (VENDU PAR 20)
EL020336	BA 20/520 CO-COOL 80 (VENDU PAR 20)
EL020341	BA 6/520 CO-COOL 120 (VENDU PAR 10)
EL020338	BA 6/520 CO-COOL 40 (VENDU PAR 10)
EL020339	BA 6/520 CO-COOL 60 (VENDU PAR 10)
EL020340	BA 6/520 CO-COOL 80 (VENDU PAR 10)

BANDE ABRASIVE BOIS ET MÉTAL

MAKITA

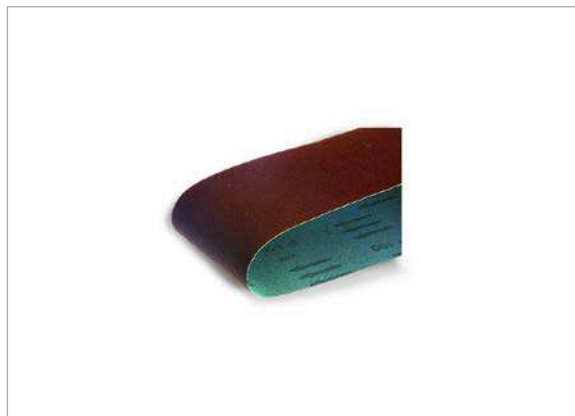

PONCEUSE MAKITA 9403
POUR PONCEUSE A BANDE 9403 - MAKITA

RÉF. ART.	DESCRIPTION
EL009603	BANDE ABRASIVE G40 POUR BOIS ET MÉTAL L.610MM L.100MM
EL009604	BANDE ABRASIVE G60 POUR BOIS ET MÉTAL L.610MM L.100MM
EL009605	BANDE ABRASIVE G80 POUR BOIS ET MÉTAL L.610MM L.100MM

BANDE ABRASIVE PONCEUSE FEIN BF 10-280 E



POUR PONCEUSE A BANDE EL020162 (VENDU PAR 10)

RÉF. ART.	DESCRIPTION
EL020211	BANDE ABRASIVE GR120 L.20 PONCEUSE FEIN BF 10-280 E
EL020210	BANDE ABRASIVE GR80 L.20 PONCEUSE FEIN BF 10-280 E
EL020212	BANDE ABRASIVE GR80 L.20 PONCEUSE FEIN RS 12-70E
EL020213	BANDE ABRASIVE GR80 L.40 PONCEUSE FEIN RS 12-70E

photos non contractuelles

DISQUE A LAMELLES "Z"

S.E.A.

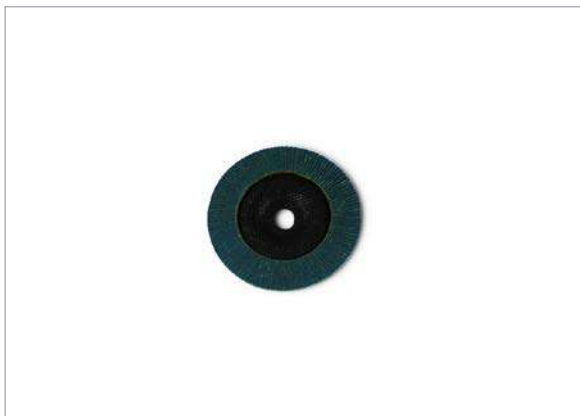

RÉF. ART.	DESCRIPTION	DIAMETRE
EL005673	Ø 178 SF BOMBE GRAIN 60	D 178 MM

DISQUE À PONCER

S.E.A.



RÉF. ART.	DESCRIPTION
EL005706	C24 D.178MM
EL005704	SA24
EL005703	SA60

DISQUE ABRASIF

MAKITA



PONCEUSE MAKITA BO6030J
DISQUE ABRASIF Ø 150MM G80 10P VELCRO B POUR PON-
CEUSE BO6030

RÉF. ART.	DESCRIPTION
EL010502	10 PIÈCES VELCRO B GRAIN 80 D.150MM
EL010503	10 PIÈCES VELCRO B, GRAIN 120 D.150MM
EL010504	10 PIÈCES VELCRO B, GRAIN 180 D.150MM
EL010505	10 PIÈCES VELCRO B, GRAIN 240 D.150MM
EL010506	10 PIÈCES VELCRO B, GRAIN 320 D.150MM
EL010501	10 PIÈCES VELCRO B, GRAIN 40 D.150MM

DISQUE ABRASIF AUTO-AGRIPPANT

MAKITA



PONCEUSE MAKITA DBO180RMJ_PONCEUSE MAKITA
BO5041J
10 TROUS MULTIMATERIAUX (prévoir plateau EL010450)

RÉF. ART.	DESCRIPTION
EL009683	10 TROUS, GRAIN 180 D.125MM
EL009684	11 TROUS, GRAIN 240 D.125MM
EL009685	12 TROUS, GRAIN 320 D.125MM
EL009678	7 TROUS, GRAIN 40 D.125MM
EL009680	8 TROUS, GRAIN 80 D.125MM
EL009682	9 TROUS, GRAIN 120 D.125MM

photos non contractuelles

DISQUE VELCRO PERFORÉ GRAIN

S.E.A.



PONCEUSE MAKITA BO6030J

RÉF. ART.	DESCRIPTION	DIAMETRE
EL001875	120 D.150MM	D 150 MM
EL001876	60 D.150MM	D 150 MM
EL001877	80 D.150MM	D 150 MM

SOLUTION RECYCLAGE CASQUES ELECTROPORTATIFS



RÉF. ART.

RECYCLAGE

SIGNIFICATION DISTRIPLUS & WE LOVE LIFE



RÉF. ART.

PICTOS

RAINUREUSE D90 AVEC 2 DISQUES D.150MM SPIT

spit



we
life
b
DISTRIPUS⁺

RÉF. ART.	PUISSANCE	REFERENCE FABRICANT
EL007754	Pu 2500 W	811245

PACK 2 DISQUES XTREME

spit



RAINUREUSE SPIT D90E

RÉF. ART.	DESCRIPTION	DIAMETRE	REFERENCE FABRICANT
EL007574	BETON D.150	D 150 MM	610063
EL007586	UNIVERSEL D.150	D 150 MM	610197

PACK 2 DISQUES DIAM. 150

spit



RAINUREUSE SPIT D90E

RÉF. ART.	DESCRIPTION	DIAMETRE	REFERENCE FABRICANT
EL007570	SILVER TURBO T	D 150 MM	610035

photos non contractuelles

RIVETEUSE RT-6A +B22/5.2 + C4/36

HILTI

RÉF. ART.	REFERENCE FABRICANT
EL020853	3643871

SUR COMMANDE = soumis à des délais supérieurs à ceux habituels

SUR COMMANDE = SOUMIS À DES DÉLAIS SUPÉRIEURS À CEUX HABITUELS



RÉF. ART.
SUR COMMANDE

VERIFIEZ LA DISPONIBILITE DE NOS PRODUITS

DISTRIMO



En scannant le QR code, vérifiez le stock des produits à l'aide des références et de la barre de recherche

RÉF. ART.	DESCRIPTION
SITE WEB	http://distrimo.bouygues-construction.com/

GROUPE HYDRAULIQUE MOBILE 18V - SANS COUPLEUR

KLAUKE



Poids 6,4kg

RÉF. ART.

EL020180

MACHOIRES DE PRESSAGE NPR PM



RÉF. ART.	DESCRIPTION	REFERENCE FABRICANT
EL019883	MACHOIRES DE PRESSAGE NPR PM G 16 MINI	2206209
EL019884	MACHOIRES DE PRESSAGE NPR PM G 20 MINI	2206270
EL019885	MACHOIRES DE PRESSAGE NPR PM G 26 MINI	2206274
EL019886	MACHOIRES DE PRESSAGE NPR PM G 32 MINI	2206275
EL019887	MACHOIRES DE PRESSAGE NPR PM G 40 MINI	2206276
EL019894	MACHOIRES DE PRESSAGE NPR PM TH 26	2207518
EL019895	MACHOIRES DE PRESSAGE NPR PS G 16	2206283
EL019896	MACHOIRES DE PRESSAGE NPR PS G 20	2206284
EL019897	MACHOIRES DE PRESSAGE NPR PS G 26	2206285
EL019898	MACHOIRES DE PRESSAGE NPR PS G 32	2206286
EL019899	MACHOIRES DE PRESSAGE NPR PS G 40	2206287
EL019900	MACHOIRES DE PRESSAGE NPR PS G 50	2206288
EL105519	Machoières de pressage NPR PM M 12 mini - UNITE	2206277
EL105520	Machoières de pressage NPR PM M 15 mini - UNITE	2206278
EL105521	Machoières de pressage NPR PM M 18 mini - UNITE	2206279
EL105522	Machoières de pressage NPR PM M 22 mini - UNITE	2206280
EL105523	Machoières de pressage NPR PM M 28 mini - UNITE	2206281
EL105524	Machoières de pressage NPR PM M 35 mini - UNITE	2206282
EL920017	TH 12 MINI	2168630
EL920018	TH 16 MINI	2163325
EL920019	TH 18 MINI	2163326
EL920020	TH 20 MINI	2163327
EL105525	Machoières de pressage NPR PS M 12 - UNITE	2206289
EL105526	Machoières de pressage NPR PS M 15 - UNITE	2206290
EL105527	Machoières de pressage NPR PS M 18 - UNITE	2206291
EL105528	Machoières de pressage NPR PS M 22 - UNITE	2206292
EL105529	Machoières de pressage NPR PS M 28 - UNITE	2206293
EL105530	Machoières de pressage NPR PS M 35 - UNITE	2206294

photos non contractuelles

MACHOIRES MERE POUR INSERT NPR

HILTI

RÉF. ART.	DESCRIPTION	REFERENCE FABRICANT
EL020632	PS	2254453

MACHOIRES POUR NPR PS

HILTI

RÉF. ART.	DESCRIPTION	REFERENCE FABRICANT
EL019930	TH 12	2168637
EL019931	TH 16	2163186
EL019932	TH 18	2163187
EL019933	TH 20	2163188
EL019934	TH 25	2163189
EL019935	TH 32	2163300
EL019936	TH 40	2163301
EL019937	TH 50	2163302
EL019938	U 12	2168638
EL019939	U 14	2168639
EL019940	U 16	2163303
EL019941	U 18	2163304
EL019942	U 20	2163305
EL019943	U 25	2163306
EL019944	U 32	2163307
EL019945	U 40	2163308
EL019946	V 12	2168650
EL019947	V 14	2168651
EL019948	V 15	2163309
EL019949	V 16	2168652
EL019950	V 18	2163310
EL019951	V 22	2163311
EL019952	V 28	2163312
EL019953	V 35	2163313
EL019954	V 42	2168653
EL019955	V 54	2163314

MACHOIRES POUR NPR PM

HILTI

RÉF. ART.	DESCRIPTION	REFERENCE FABRICANT
EL019911	TH 25	2163328
EL019912	TH 32	2163329
EL019913	TH 40	2163330
EL019914	U 12	2168631
EL019915	U 14	2168632
EL019916	U 16	2163331
EL019917	U 18	2163332
EL019918	U 20	2163333
EL019919	U 25	2163334
EL019920	U 32	2163335
EL019921	U 40	2163336
EL019922	V 12	2168633
EL019923	V 14	2168634
EL019924	V 15	2163337
EL019925	V 16	2168635
EL019926	V 18	2163338
EL019927	V 22	2163339
EL019928	V 28	2163340
EL019929	V 35	2163341

photos non contractuelles

SCIE À RUBAN SUR BATTERIE MAKITA DPB180RME

MAKITA



Batterie 18 V -4 Ah - Capacité de coupe (tube acier) 120 mm -
Vendu sans carter inférieur - 6,4 kg - **Nécessite un accord de la
Prévention Santé Sécurité**

RÉF. ART.
ELO17248

SCIE À RUBAN SUR BATTERIE MAKITA DPB181RME

MAKITA



Batterie 18 V -4 Ah - Vendu sans carter inférieur - Capacité de
coupe (tube acier) 64 mm Vitesse de la bande maximale : 192 m/
min - 3,2 kg - **Nécessite un accord PSS**

RÉF. ART.
ELO20171

LAME DE SCIE A RUBAN

MAKITA



RÉF. ART.	DESCRIPTION
ELO20420	pour scie à ruban sur batterie DPB181RME POUR ELO20171

LAME SCIE A RUBAN DPB180RME POUR METAUX ET PVC

MAKITA

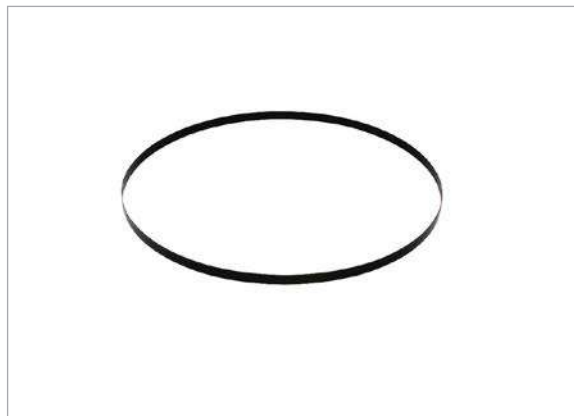

COUPE 4 A 5MM - 18 DENTS/POUCE pour scie à ruban filaire
DPB180RME

RÉF. ART.
ELO17255

photos non contractuelles

**LOT DE 3 LAMES SCIE A RUBAN
DPB180RME POUR METAUX ET PVC**

COUPE 4 A 5MM - 14 DENTS/POUCE POUR SCIE À RUBAN FILAIRE
DPB180RME

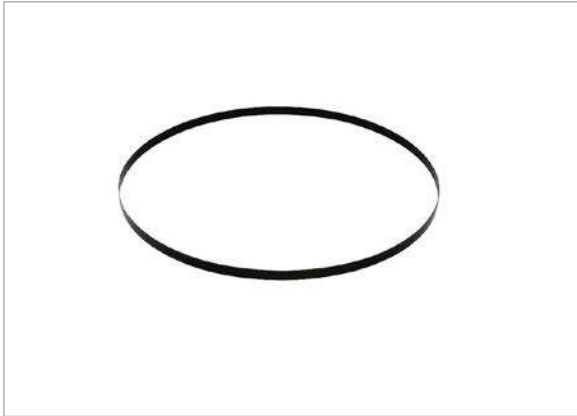

RÉF. ART.
EL017807

**SUR COMMANDE = soumis à des délais
supérieurs à ceux habituels**

SUR COMMANDE = SOUMIS À DES DÉLAIS SUPÉRIEURS À CEUX HABITUELS



RÉF. ART.
SUR COMMANDE

TRANSPORT EXPRESS

LE SERVICE TRANSPORT EXPRESS SUR MESURE VOUS ASSURE L'ENLÈVEMENT
ET LA LIVRAISON DE COLIS, PLANS, PALETTES ET HORS-GABARIT DANS LES
DÉLAIS LES PLUS COURTS.



RÉF. ART.	DESCRIPTION
Transport express	L.BONAVENTURE@bouygues-construction.com j.imboden@bouygues-construction.com

SCIE CARRELAGE DIAMINIBOX 200

SIDAMO



[800W - longueur de coupe : 200mm 420mm - 15kg]

Obligatoire avec disque à jante continue (EL010301)

RÉF. ART.
EL010332

SCIE CIRCULAIRE À MÉTAUX MAKITA DCS553RMJ

MAKITA



Batterie : 18V - 5Ah - Spécial coupe des métaux - Profondeur de coupe 57,5 mm - Vitesse à vide max. 3900 tr/min - 2,9 kg - Dé-coupe à froid sans étincelle et moins de bavure

RÉF. ART.
EL020170

SCIE CIRCULAIRE MAKITA 5903RKX2

MAKITA



Livrée en coffret avec câble d'alimentation de 5ml

RÉF. ART.	DESCRIPTION
EL005712	2000W 85MM DE COUPE

SCIE CIRCULAIRE MAKITA SUR BATTERIE

MAKITA



[Prof. coupe max à 90° = 66mm - 18V - 3,5kg] Prévoir rail(s)

Compatible rail (EL010285) et adaptateur (EL010295)

RÉF. ART.	DESCRIPTION
EL010290	DHS630RMJ

photos non contractuelles

SCIE CIRCULAIRE MT55CC

MAFELL



Prévoir rail/règle de guidage

RÉF. ART.	DESCRIPTION
EL005404	MAFELL

**SCIE COUPE TUBE P400 + ROULEAUX
PIPE CUT P400**

EXACTTOOLS



SCIE COUPE TUBE P400 +ROULEAUX PIPE CUT P400 POUR PVC,PE PP Scie circulaire spéciale pour tubes PVC Ømaxi 400mm

RÉF. ART.
EL009771

SCIE COUPE TUBE V1000 EQUIPEE

EXACTTOOLS



RÉF. ART.	REFERENCE FABRICANT
EL009772	V1000

SCIE PLONGEANTE FESTOOL TS 75 EBQ-PLUS-BT -

FESTOOL



EMBALLAGE ABS

RÉF. ART.
EL005407

photos non contractuelles

SCIE SCIRCULAIRE GROS DÉBIT MAKITA 5143R

MAKITA



Spéciale filière bois – filaire 2200W – raccord d'aspiration – Profondeur de coupe 130mm – Vitesse à vide 2700tr/min – 14kg - **Formation renforcée obligatoire** et **Nécessite un accord de la Prévention Santé Sécurité**

RÉF. ART.

EL018363

SCIE ARASANTE VIRUTEX RZ270S

MAFELL



Découpe des bas de portes sans démontage

RÉF. ART.

EL009675

SCIE CARRELAGE SUR TABLE IQ TS244



RÉF. ART.

EL107121

REFERENCE FABRICANT

TS244

SCIE COUPE TUBE PIPECUT

ERFI FRANCE



RÉF. ART.

EL009771

DESCRIPTION

P400 POUR PVC,PE PP ...100 A 400mm

REFERENCE FABRICANT

4944050

COMBINE DIAMINIPRO 180

SIDAMO



RÉF. ART.

EL107774

DESCRIPTION

- XC 30L AVEC DISQUE PRO

REFERENCE FABRICANT

SID471

photos non contractuelles

ADAPTATEUR RAIL

HILTI



SCIE CIRCULAIRE MAKITA 5903RK

Une seule cheville pour tous les supports creux de 10 à 92 mm - 100 - 25

RÉF. ART.	DESCRIPTION	REFERENCE FABRICANT
EL010281	SCM 22-A (VENDU A L'UNITÉ)	2098868

PIÈCE DE RACCORDEMENT POUR ACCOUPLER 2 RAILS SUR MT55C

MAFELL



SCIE CIRCULAIRE MAFELL MT55CC

RÉF. ART.
EL008691

REGLE DE GUIDAGE POUR SCIE PLONGEANTE FESTOOL

FESTOOL



SCIE PLONGEANTE FESTOOL TS 75

RÉF. ART.
EL002417

REGLE DE GUIDAGE POUR SCIE MAFELL MT55CC L.110CM

MAFELL



we
life

SCIE CIRCULAIRE MAFELL MT55CC

RÉF. ART.	DESCRIPTION
EL003805	REGLE DE GUIDAGE POUR SCIE MAFELL MT55C L.160CM

ADAPTATEUR RAIL DE GUIDAGE POUR DJV180RMJ MAKITA

MAFELL

we
life

SCIE CIRCULAIRE MAFELL MT55CC

RÉF. ART.	DESCRIPTION
EL002418	REGLE DE GUIDAGE POUR SCIE MAFFEL MT55CC L.110CM

RALLONGE DE TABLE POUR SCIE IQ TS244



RÉF. ART.	REFERENCE FABRICANT
EL107724	TS244/RAL

RAIL DE GUIDAGE POUR 5903R

MAKITA



RÉF. ART.	DESCRIPTION	REFERENCE FABRICANT
EL104229	RAIL DE GUIDAGE 3000MM POUR 5903R	194367-7

SUPPORT COUPE D'ONGLETS POUR SCIE IQ TS244



RÉF. ART.	REFERENCE FABRICANT
EL107725	TS244/ONG

photos non contractuelles

Batterie 18V 4,4AH pour Kartao-40



RÉF. ART.	REFERENCE FABRICANT
EL112027	KA40036

RESERVOIR D'EAU 40 L AUTONOME



RÉF. ART.	DESCRIPTION	REFERENCE FABRICANT
EL107125	AVEC 1 BATTERIE ET 1 CHARGEUR	KARTAO-40LI

Chargeur 220V pour Kartao-40



RÉF. ART.	REFERENCE FABRICANT
EL112028	KA40041

VERIFIEZ LA DISPONIBILITE DE NOS PRODUITS

DISTRIMO



En scannant le QR code, vérifiez le stock des produits à l'aide des références et de la barre de recherche

RÉF. ART.	DESCRIPTION
SITE WEB	http://distrimo.bouygues-construction.com/

photos non contractuelles

LAME SCIE CIRC. SCB M

HILTI



SCIE CIRCULAIRE MAKITA 5903RK

RÉF. ART.	DESCRIPTION	REFERENCE FABRICANT
EL013904	XCUT 165	2023994

LAME SCIE CIRC. SCB WS CC

HILTI



SCIE CIRCULAIRE MAKITA 5903RK

RÉF. ART.	DESCRIPTION	DIAMETRE	REFERENCE FABRICANT
EL018481	190X30 Z54	D 190 MM	2112324

LAME SCIE CIRC. SCB WU

HILTI



SCIE CIRCULAIRE MAKITA 5903RK

Lame bois universelle pr coupes droites dans bois massif, PVC, bois tendre et dur, bois avec clous, contreplaqué, stratifié. - Le nombre indique la longueur de la lame en cm - 5 - 5

RÉF. ART.	DESCRIPTION	DIAMETRE	REFERENCE FABRICANT
EL020538	190X30 Z24A	D 190 MM	2145815

LAME SCIE CIRCULAIRE SCB WS CC

HILTI



SCIE CIRCULAIRE MAKITA 5903RK

Lame bois universelle pr coupes droites dans bois massif, PVC, bois tendre et dur, bois avec clous, contreplaqué, stratifié. - Le nombre indique la longueur de la lame en cm - 5 - 6

RÉF. ART.	DESCRIPTION	LONGUEUR	DIAMETRE	REFERENCE FABRICANT
EL008451	160X20 Z54	L 54 MM	D 160 MM	2037950
EL009436	230X30 Z48	L 48 MM	D 230 MM	3518614

photos non contractuelles

LAME SCIE CIRCULAIRE SCB WS FT



SCIE CIRCULAIRE MAKITA 5903RK

RÉF. ART.	DESCRIPTION	LON- GUEUR	DIAMETRE	REFERENCE FAB- RICANT
EL010391	160X20 Z14	L 14 MM	D 160MM	2037818
EL010392	190X30 Z12		D 190 MM	2037957
EL008453	230X30 Z18	L 18 MM	D 230 MM	3518617
EL009777	LAME SCIE CIRCULAIRE SCB WSFT 230X30Z18	L 18 MM	D 230MM	2037960

LAME SCIE CIRCULAIRE SC-C MUI



SCIE CIRCULAIRE MAKITA 5903RK

RÉF. ART.	DESCRIPTION	LONGUEUR	DIAMETRE	REFERENCE FAB- RICANT
EL009231	165X20 Z40 A	L 40 MM	D 165MM	2014797
EL010334	165X20 Z40 A LOT DE 5		D 165 MM	2070234

LAME SCIE CIRCULAIRE W CSC



SCIE CIRCULAIRE MAKITA 5903RK

RÉF. ART.	DESCRIPTION	LONGUEUR	DIAMETRE	REFERENCE FABRI- CANT
EL008450	230X30 Z48 HW	L 48 MM	D 230 MM	2037961

LAME SCIE CIRCULAIRE SCB WU



SCIE CIRCULAIRE MAKITA 5903RK

RÉF. ART.	DESCRIPTION	LONGUEUR	DIAMETRE	REFERENCE FAB- RICANT
EL008446	160X20 Z24 HW		D 160MM	2037817
EL009437	165X20 Z24A	L 24 MM	D 165 MM	2037951
EL010050	165X20 Z24A LOT DE 5	L 24 MM	D 165 MM	3518499
EL009821	180X20 Z24		D 180 MM	2037952
EL009391	230X30 Z24 LOT DE 5	L 24 MM	D 230 MM	3518615
EL008449	230X30 Z24	L 24 MM	D 230 MM	2037959

photos non contractuelles

LAME BOIS DE SCIE CARBURE DE TUNGSTÈNE 60 DENTS POUR LS1040

MAKITA



SCIE A ONGLET MAKITA LS1040
LAME BOIS 60 DENTS POUR LS1040 CARBURE DE TUNGSTÈNE BOIS - 260/30/60

RÉF. ART.	DIAMETRE
EL010440	D 260 MM

LAME CARBURE METAL

MAKITA

RÉF. ART.	DESCRIPTION
EL020796	Ø305mm 60 DENTS PR TRONC. METAL-LC1230

LAME DE SCIE

MAKITA



SCIE CIRCULAIRE MAKITA DHS630RMJ
POUR SCIE DHS630RMJ - MAKITA

RÉF. ART.	DESCRIPTION	DIAMETRE
EL010294	24 DENTS POUR BOIS D.165MM EP.1,5MM	D 165 MM
EL010296	40 DENTS POUR LS1040 D.260MM, ALÉSAGE D.30MM	D 260 MM

LAME DE SCIE AU CARBURE

SIDAMO



RÉF. ART.	DESCRIPTION	DIAMETRE
EL002527	24 DENTS, ALÉSAGE DE 30MM, D.230MM	D 230 MM
EL002532	24 DENTS, D.160MM POUR MAFELL MT55CC	D 160 MM
EL002528	34 DENTS, ALÉSAGE DE 30MM, D.230MM	D 230 MM
EL002529	48 DENTS, ALÉSAGE DE 30MM, D.230MM	D 230 MM
EL002629	48 DENTS, D.160MM POUR MAFELL MT55CC	D 160 MM

LAME DE SCIE CIRCULAIRE

MAKITA



SCIE CIRCULAIRE MAKITA DHS630RMJ
LAME SCIE CIRCULAIRE 18V 16 DENTS POUR BOIS
165/20/16

RÉF. ART.	DESCRIPTION	DIAMETRE
EL010467	18V 16 DENTS POUR BOIS	D 165 MM
EL010468	18V 24 DENTS POUR BOIS	D 165 MM

photos non contractuelles

LAME DE SCIE SPECIALE PVC POUR SCIE FESTOOL TKS80

FESTOOL



RÉF. ART.	DESCRIPTION	REFERENCE FABRI-CANT
EL100921	LAME DE SCIE SPECIALE PVC 254X2.4X30 POUR SCIE FESTOOL TKS80	TF80L / 575977

LAME POUR SCIE ARASANTE

SIDAMO



Lame pour scie arasante 160x2,8x20-24D / bois-métal réalésage 4 trous argot pour scie arasante VIRUTEX

RÉF. ART.	DESCRIPTION	DIAMETRE
EL018302	24 DENTS ALÉSAGE 20MM D.160MM	D160 MM
EL009928	VIRUTEX RZ270S D.165MM	D 165 MM

LAME PLONGEANTE DROITE POUR COUTEAU OSCILLANT

MAKITA



COUTEAU OSCILLANT MAKITA DTM51RFJX3_COUTEAU OSCILLANT MAKITA TM3010CX1J
LAME PLONGEANTE DROITE 40 POUR COUTEAU OSCILLANT 40X65MM BOIS-CLOUS

RÉF. ART.	DESCRIPTION	LONGUEUR
EL010441	L.40MM	L 40 MM

LAME POUR SCIE PIPECUT

EXACTTOOLS



SCIE EXACT PIPECUT V1000 POUR ACIER, ALU, INOX

RÉF. ART.	DESCRIPTION
EL010305	V1000 POUR ACIER, ALU, INOX
EL010303	P400 TCT P150 POUR PLASTIQUE

LAME SCIE CIRCULAIRE CARBURE

SIDAMO



RÉF. ART.	DESCRIPTION
EL002628	210X2.8X30 24 DENTS FESTOOL

LAME SEGMENT AU CARBURE

MAKITA



COUTEAU OSCILLANT MAKITA DTM51RFJX3_COUTEAU OSCILLANT MAKITA TM3010CX1J
LAME SEGMENT CARBURE 85 G30 POUR COUTEAU OSCILLANT Ø85MM - JOINT CARRELAGE

RÉF. ART.	DESCRIPTION	LONGUEUR
EL010442	G30 POUR COUTEAU OSCILLANT L.85MM	L 85 MM

LAMES CARBURE MÉTAL POUR SCIE CIRCULAIRE DCS551RMJ

MAKITA



SCIE CIRCULAIRE

LAME CARBURE METAL Ø150MM POUR SCIE CIRCULAIRE DCS551RMJ Ø150MM - AL.20MM - 32 DENTS

RÉF. ART.	DESCRIPTION
EL017188	D.150MM

LAME METAL Ø 136 X 1.5 X 20 MM

MAKITA



RÉF. ART.	DESCRIPTION	REFERENCE FABRICANT
EL102298	30 DENTS 0°	B-69266

photos non contractuelles

LAME CIRCULAIRE SPECIALE INOX

MAKITA



RÉF. ART.	DESCRIPTION	REFERENCE FABRICANT
EL020848	D.150 ALESAGE 20 - 60 DENTS	B-47058

COFFRET TREPAND DIAMANT + GUIDE

SIDAMO



RÉF. ART.	DESCRIPTION	REFERENCE FABRICANT
EL107775	D. 6-8-10-12-19-22	11101420
EL107776	D. 29-35-44-65-68-76	11101421

DISQUE DIAMANT 55MM MATERIAUX DUR POUR SCIE IQ TS244



RÉF. ART.	REFERENCE FABRICANT
EL107123	IQDC255HM

KIT EN SEAU : POIGNEE + 100 ECROUS + 100 CROISILLONS AUTO A VIS-3MM

SIDAMO



RÉF. ART.	REFERENCE FABRICANT
EL108104	11255117

photos non contractuelles

SCIE ALIGATOR DEWALT DCS397T2

DEWALT



DISTRIPRUS

Batterie 54V - 6Ah - Lame de 43cm - 5,6kg - Découpe de briques forte densité et/ou matériaux d'isolation type fibrastyrène - **Nécessite un accord PSS**

RÉF. ART.

EL018362

SCIE ALTERNATIVE POUR TUBES JUSQU'A 440MM ASTXE 649-1

DISTRIPRUS

RÉF. ART.

EL104648

photos non contractuelles

COFFRET TE/SF/SI/AG/WSR

HILTI

RÉF. ART.	DESCRIPTION	REFERENCE FABRICANT
EL011810	TYPE 047 KIT	2045753

RÉCUPÉRATEUR DE POUSSIÈRE WSR
DRS**HILTI**

RÉF. ART.	REFERENCE FABRICANT
EL020014	2149419

photos non contractuelles

LAME SCIE CIRCULAIRE SCB WU

HILTI



SCIE SABRE SCIE SABRE MAKITA DJR183RYJ_SCIE SABRE
MAKITA DJR181RME_SCIE SABRE MAKITA JR3070CTH

RÉF. ART.	DESCRIPTION	REFERENCE FABRICANT
EL018431	LAME DE SCIE SABRE BCB 31 -2165376	2165376
EL018430	LAME DE SCIE SABRE BCB 45 -2165377	2165377

LAME DE SCIE SABRE UNIVERSELLE B. CEL

HILTI



RÉF. ART.	DESCRIPTION	REFERENCE FABRICANT
EL002588	. W-CSR SM 46	377820

LAME DE SCIE SABRE MB

HILTI



RÉF. ART.	DESCRIPTION	REFERENCE FABRICANT
EL013868	15 14 -5 LOT DE 5	2099395
EL010845	15 18 LOT DE 5	2099399
EL013870	20 18 -5 LOT DE 5	2099400
EL013871	23 14 -5 LOT DE 5	2099397

LAME DE SCIE SABRE MD

HILTI



SCIE SABRE SCIE SABRE MAKITA DJR183RYJ_SCIE SABRE
MAKITA DJR181RME_SCIE SABRE MAKITA JR3070CTH

RÉF. ART.	DESCRIPTION	REFERENCE FABRICANT
EL013872	15 10 -50 LOT DE 50	2179710
EL010846	15 10 LOT DE 5	2179711
EL013873	15 14 -5 LOT DE 5	2179713
EL013874	15 18 -5 LOT DE 5	2179715
EL013875	23 10 -200 LOT DE 200	2179718
EL013876	23 10 -50 LOT DE 50	2179719
EL013877	23 14 -5 LOT DE 5	2179722
EL013879	23 18 -5 LOT DE 5	2179724
EL013878	23 18 -50 LOT DE 50	2179723

photos non contractuelles

LAME DE SCIE SABRE METAL DEMO



RÉF. ART.	DESCRIPTION	REFERENCE FABRICANT
EL002591	300 W-CSR MD 30	2179726

Lame de scie sabre MFR



RÉF. ART.	DESCRIPTION	REFERENCE FABRICANT
EL105495	15 10 (5) - LOT DE 5	2221955
EL105496	23 10 (5) - LOT DE 5	2222115
EL105497	30 10 (5) - LOT DE 5	2221956

LAME DE SCIE SABRE METAL INOX



SCIE SABRE SCIE SABRE MAKITA DJR183RYJ_SCIE SABRE MAKITA DJR181RME_SCIE SABRE MAKITA JR3070CTH

RÉF. ART.	DESCRIPTION	REFERENCE FABRICANT
EL002593	W-CSR MS 13	2179714

Lame de scie sabre UB



RÉF. ART.	DESCRIPTION	REFERENCE FABRICANT
EL105503	20 1014 (5) - LOT DE 5	2221954

photos non contractuelles

Lame de scie sabre UD

HILTI

RÉF. ART.	DESCRIPTION	REFERENCE FABRICANT
EL105506	20 1014 (175) - LOT DE 175	2222111
EL105507	20 1014 (35) - LOT DE 35	2222110
EL105508	30 1014 (35) - LOT DE 35	2222113
EL105509	30 1014 (5) - LOT DE 5	2222112

LAME DE SCIE SABRE UNIVERSEL B

HILTI

RÉF. ART.	DESCRIPTION	REFERENCE FABRICANT
EL002594	. CEL. W-CSR SM 300	369055
EL002595	LAME DE SCIE SABRE UNIV B. CEL. W-CSR SM 40	369054

LAME DE SCIE SABRE UDX

HILTI

RÉF. ART.	DESCRIPTION	REFERENCE FABRICANT
EL018904	23 68 (3) LOT DE 3	2140378
EL018905	30 68 (3) LOT DE 3	2140720

LAME DE SCIE SABRE WB

HILTI

RÉF. ART.	DESCRIPTION	REFERENCE FABRICANT
EL020274	23 6 -5 LOT DE 5	2222135
EL020273		2222136

photos non contractuelles

LAME DE SCIE SABRE W-CSR

HILTI



RÉF. ART.	DESCRIPTION	REFERENCE FABRICANT
EL002598	MD23 LOT DE 5	2179720
EL002603	SB23	285809
EL002604	SB30	285810
EL002605	SM15 LOT DE 3	284554

Lame de scie sabre WD

HILTI



RÉF. ART.	DESCRIPTION	REFERENCE FABRICANT
EL105510	15 6 (35) - LOT DE 35	2222125
EL105511	15 6 (5) - LOT DE 5	2222128
EL105513	23 6 (35) - LOT DE 35	2222129
EL105514	23 6 (5) - LOT DE 5	2222126
EL013901	23 6 -175 LOT DE 175	2099380

LAME DE SCIE SABRE FONTE-INOX

MAKITA



SCIE SABRE MAKITA

Lame Scie Sabre fonte-inox coupe 228x1,25MM MAKITA - VENDUE A L'UNITE

RÉF. ART.	DESCRIPTION
EL018290	COUPE L.228MM

LAME SCIE SABRE

MAKITA



SCIE SABRE MAKITA

LAME SCIE SABRE BI-METAL JR3070CT-DJR181RME-METAL 130X152MM - PAR 5

RÉF. ART.	DESCRIPTION	LONGUEUR
EL010462	BI-METAL JR3070CT-DJR181RME-METAL L.130MM	L 130 MM
EL010464	BOIS JR3070CT- DJR181RME L.180MM	L 180 MM
EL010470	BOIS-CLOUS DJR183RYJ / BOIS-CLOUS	L 80 MM
EL010463	BOIS-METAL-PVC JR3070CT- DJR181RME	L 130 MM
EL010469	TOLE DJR183RYJ - TOLE 1,5 A 4MM	L 75 MM

photos non contractuelles

LAMES SCIES SABRE CARBURE



RÉF. ART.	DESCRIPTION
EL020670	S 1155 CHM 225
EL020666	S 1167 XHM 250
EL020671	S 1255 CHM 300
EL020667	S 1267 XHM 300
EL020668	S 555 CHM 100
EL020669	S 955 CHM 150
EL020665	S 967 XHM 150

VERIFIEZ LA DISPONIBILITE DE NOS PRODUITS

DISTRIMO



En scannant le QR code, vérifiez le stock des produits à l'aide des références et de la barre de recherche

RÉF. ART.	DESCRIPTION
SITE WEB	http://distrimo.bouygues-construction.com/

photos non contractuelles

SCIE À ONGLET RADIALE MAKITA LS1019L

MAKITA



Hauteur coupe max. à 90°=91 mm - Largeur coupe max. à 90°= 310 mm - Raccord d'aspiration ou sac à poussière - 1510 W - 26,3 kg - **Fixation obligatoire sur établi ou table** - code établi à commander : EL010277

RÉF. ART.

EL018361

ETABLI POUR SCIE LS1040 ET LS1019L

MAKITA



SCIE A ONGLET MAKITA LS1040

RÉF. ART.

DESCRIPTION

EL010277

L.740MM L.600MM

ÉTAUX VERTICAUX POUR SCIE LS1040 POUR FIXATION PIÈCES

MAKITA



SCIE A ONGLET MAKITA LS1040

RÉF. ART.

REFERENCE FABRICANT

EL010278

122536-0

SCIE STATIONNAIRE FESTOOL SUR TABLE TKS 80 EBS

FESTOOL



pour délignage

RÉF. ART.

DESCRIPTION

REFERENCE FABRICANT

EL100428

- SET

TKS 80 EBS - SET

photos non contractuelles

LAME DE SCIE UNIVERSELLE 254X2.4X30W40 POUR TKS 80

FESTOOL

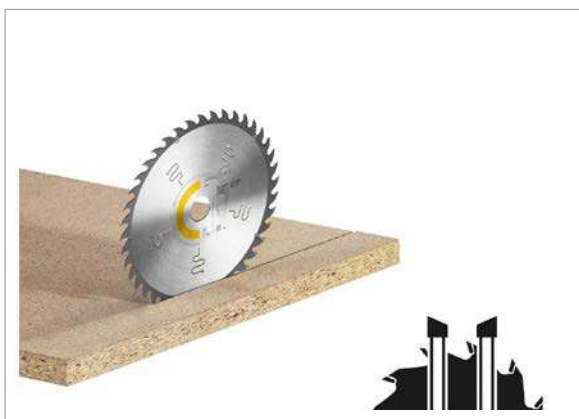

RÉF. ART.	REFERENCE FABRICANT
EL100430	575975

CARTOUCHE KT-TKS 80 POUR SCIE TKS 80

FESTOOL



RÉF. ART.	REFERENCE FABRICANT
EL100429	575851

photos non contractuelles

SCIE SPIRALE SANS-FIL SCO 6-A22

HILTI



remplace EL018753 - sans batterie ni chargeur

RÉF. ART.	DESCRIPTION	REFERENCE FABRICANT
EL020581	BOÎTE - NU	2193410

SCIE SAUTEUSE 18V/5A MAKITA DJV182RTJ

MAKITA



800 à 3500 cps/mn - Course de 26mm - 2,6kg

RÉF. ART.
EL018419

DÉCOUPEUSE DE PLACO MAKITA DSD180Z SANS BATTERIE

MAKITA



Batterie 18V - 5Ah - Découpe de plaques de Placoplatre sans poussière. Réservations, reprises, etc. - Raccord d'aspiration - 1,9kg - Découpe sans toucher le rail, idéal découpe au plafond- Prévoir le pack 2 batteries + chargeur 18V

RÉF. ART.
EL020184

photos non contractuelles

ADAPTATEUR RAIL DE GUIDAGE POUR DJV180RMJ MAKITA

MAKITA



SCIE SAUTEUSE MAKITA DJV180RMJ

RÉF. ART.
EL010295

LAME SCIE SAUTEUSE HPL



RÉF. ART.	DESCRIPTION	REFERENCE FABRICANT
EL020539	67 1.8 HM (5)	2185400

LAME SCIE SAUTEUSE P 72 2 HSS



RÉF. ART.	DESCRIPTION	REFERENCE FABRICANT
EL020540	(25)	2154893

LAME SCIE SAUTEUSE SJB BC



RÉF. ART.	DESCRIPTION	REFERENCE FABRICANT
EL020541	10 JEU	2186209

photos non contractuelles

LAME SCIE SAUTEUSE UD



RÉF. ART.	DESCRIPTION	REFERENCE FABRICANT
EL020543	105 P HM (5)	2185149

LAME SCIE SAUTEUSE MB



RÉF. ART.	DESCRIPTION	REFERENCE FABRICANT
EL018909	104 1.2 HSS (25) - LOT DE 25	2154875
EL018910	104 1.2 HSS (5) - LOT DE 5	2154887
EL018911	108 2 HSS (25) - LOT DE 25	2154873
EL018912	108 2 HSS (5) - LOT DE 5	2154885
EL018913	67 1 HSS (25) - LOT DE 25	2154876
EL018914	67 1 HSS (5) - LOT DE 5	2154888
EL018915	67 C HSS (25) - LOT DE 25	2154877
EL018916	67 C HSS (5) - LOT DE 5	2154889
EL018917	67 P HSS (25) - LOT DE 25	2154872
EL018918	67 P HSS (5) - LOT DE 5	2154884
EL018919	67 S HSS (25) - LOT DE 25	2154874
EL018920	67 S HSS (5) - LOT DE 5	2154886

LAME SCIE SAUTEUSE AL 75



RÉF. ART.	DESCRIPTION	REFERENCE FABRICANT
EL018908	3 HSS (5) - LOT DE 5	2154879

photos non contractuelles

LAME SCIE SAUTEUSE MD



RÉF. ART.	DESCRIPTION	REFERENCE FABRICANT
EL018921	107 1.8 BIM (25) - LOT DE 25	2154717
EL018922	107 1.8 BIM (5) - LOT DE 5	2154881
EL018923	155 2 BIM (25) - LOT DE 25	2154718
EL018924	155 2 BIM (5) - LOT DE 5	2154882
EL018925	220 1.1 BIM (10) - LOT DE 10	2154870
EL018926	220 1.1 BIM (2) - LOT DE 2	2089204
EL018927	59 1.1 HM (5) - LOT DE 5	2154880
EL018928	59 1.5 BIM (25) - LOT DE 25	2154871
EL018929	59 1.5 BIM (5) - LOT DE 5	2154883
EL018930	67 1.1 BIM (25) - LOT DE 25	2122261
EL018931	67 1.1 BIM (5) - LOT DE 5	2114719
EL018932	67 1.9 BIM (25) - LOT DE 25	2122262
EL018933	67 1.9 BIM (5) - LOT DE 5	2115080
EL018934	77 P BIM (25) - LOT DE 25	2154719
EL018935	77 P BIM (5) - LOT DE 5	2150143

LAME SCIE SAUTEUSE P



RÉF. ART.	DESCRIPTION	REFERENCE FABRICANT
EL018936	72 2 HSS (5) - LOT DE 5	2154898
EL018937	89 3.3 HM (5) - LOT DE 5	2154899

LAME SCIE SAUTEUSE PF



RÉF. ART.	DESCRIPTION	REFERENCE FABRICANT
EL018938	105 4.3 TC (5) - LOT DE 5	2154896
EL018939	75 4.3 HM (5) - LOT DE 5	2154895

LAME SCIE SAUTEUSE SJB



RÉF. ART.	DESCRIPTION	REFERENCE FABRICANT
EL020542	GP JEU	2149340

photos non contractuelles

LAME SCIE SAUTEUSE T 57 RIFF



RÉF. ART.	DESCRIPTION	REFERENCE FABRICANT
EL018940	(5) LOT DE 5	2154897

LAME SCIE SAUTEUSE WB



RÉF. ART.	DESCRIPTION	REFERENCE FABRICANT
EL018941	125 4 HCS (25) - LOT DE 25	2154910
EL018942	125 4 HCS (5) - LOT DE 5	2154920
EL018943	56 2 HCS (25) - LOT DE 25	2154912
EL018944	56 2 HCS (5) - LOT DE 5	2154922
EL018945	67 2 HCS (25) - LOT DE 25	2154911
EL018946	67 2 HCS (5) - LOT DE 5	2154921
EL018528	77 P HCS LOT DE 5	2114714
EL018947	77 P HCS (25) - LOT DE 25	2122146

LAME SCIE SAUTEUSE UB



RÉF. ART.	DESCRIPTION	REFERENCE FABRICANT
EL018474	108 P BIM LOT DE 25	2154900
EL018473	108 P BIM LOT DE 5	2154901

LAME SCIE SAUTEUSE W-CSJ



RÉF. ART.	DESCRIPTION	REFERENCE FABRICANT
EL002646	M 50/1.2 PRECISION METAUX	378123
EL002665	W 74/R DENTURE INVERSEE	378120

photos non contractuelles

LAME SCIE SAUTEUSE WD

HILTI



RÉF. ART.	DESCRIPTION	REFERENCE FABRICANT
EL018948	129 4 HCS (25) - LOT DE 25	2154902
EL018949	129 4 HCS (5) - LOT DE 5	2154913
EL018950	155 4 HCS (25) - LOT DE 25	2154903
EL018951	220 4 HCS (10) - LOT DE 10	2154904
EL018952	220 4 HCS (2) - LOT DE 2	2089205
EL018953	56 1.4 HCS (25) - LOT DE 25	2154909
EL018954	56 1.4 HCS (5) - LOT DE 5	2154919
EL018955	72 P BIM (25) - LOT DE 25	2154905
EL018956	72 P BIM (5) - LOT DE 5	2154915
EL018957	77 1.7 BIM (25) - LOT DE 25	2154907
EL018958	77 1.7 BIM (5) - LOT DE 5	2154917
EL018959	77 2.5 HCS (25) - LOT DE 25	2122149
EL018960	77 2.5 HCS (5) - LOT DE 5	2114717
EL018961	77 2.7 HCS (25) - LOT DE 25	2122148
EL018962	77 2.7 HCS (5) - LOT DE 5	2114716
EL018963	77 4 HCS (25) - LOT DE 25	2122260
EL018964	77 4 HCS (5) - LOT DE 5	2114718
EL018476	77 P HCS LOT DE 25	2122147
EL018475	77 P HCS LOT DE 5	2114715
EL018472	93 2.5 HCS LOT DE 25	2154906
EL018471	93 2.5 HCS LOT DE 5	2154916
EL018401	155 4 HCS	2154914

LAME DE SCIE SAUTEUSE À CHANTOURNER

MAKITA



SCIE SAUTEUSE HILTI WSJ 850-ET_SCIE SAUTEUSE HILTI WSJ 850-EB_SCIE SAUTEUSE MAKITA DJV180RMJ
LAME SCIE SAUTEUSE POUR METAL- ALU-INOX-PVC A CHANTOURNER 52X76MM - PAR 5

RÉF. ART.	DESCRIPTION	LONGUEUR
EL010461	L.52MM	L 52 CM

LAME DE SCIE SAUTEUSE DIAMANT SPECIALE PLASTIQUE

PFERD



DIA-SSB 50/75 D 357

RÉF. ART.
EL020627

photos non contractuelles

LAME DE SCIE SAUTEUSE POUR BOIS, MÉTAL, ALU

MAKITA



SCIE SAUTEUSE HILTI WSJ 850-ET_SCIE SAUTEUSE HILTI WSJ 850-EB_SCIE SAUTEUSE MAKITA DJV180RMJ 73X100MM -PAR 5

RÉF. ART.	DESCRIPTION	LONGUEUR
EL010466	L.73MM	L 73 CM

LAME DE SCIE SAUTEUSE POUR MÉTAL, ALU, INOX, PVC

MAKITA



SCIE SAUTEUSE HILTI WSJ 850-ET_SCIE SAUTEUSE HILTI WSJ 850-EB_SCIE SAUTEUSE MAKITA DJV180RMJ 52X76MM - PAR 5

RÉF. ART.	DESCRIPTION	LONGUEUR
EL010460	L.52MM	L 52 CM

LAME DE SCIE SAUTEUSE POUR BOIS, PVC, CP

MAKITA



SCIE SAUTEUSE HILTI WSJ 850-ET_SCIE SAUTEUSE HILTI WSJ 850-EB_SCIE SAUTEUSE MAKITA DJV180RMJ 50X76MM -PAR 5

RÉF. ART.	DESCRIPTION	LONGUEUR
EL010458	L.50MM	L 50 MM
EL010465	L.73MM	L 73 CM

LAME DE SCIE SAUTEUSE BI-MÉTAL POUR METAL, ALU, NON FERREUX

MAKITA

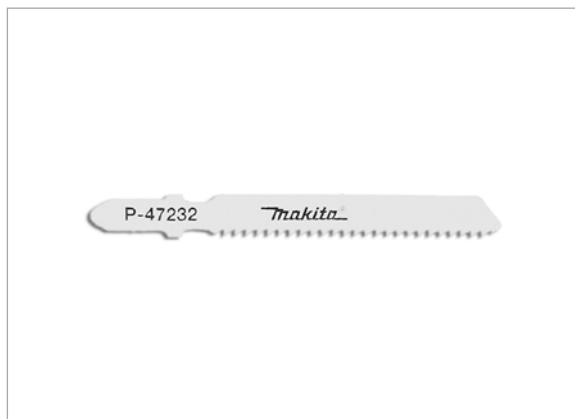

SCIE SAUTEUSE HILTI WSJ 850-ET_SCIE SAUTEUSE HILTI WSJ 850-EB_SCIE SAUTEUSE MAKITA DJV180RMJ 55X80MM -PAR 5

RÉF. ART.	DESCRIPTION	LONGUEUR
EL010507	LAME SCIE SAUTEUSE BI-MÉTAL POUR METAL, ALU, NON FERREUX	L 55 MM

photos non contractuelles

LAME DE SCIE SAUTEUSE POUR BOIS, PVC, CP À CHANTOURNER

MAKITA



SCIE SAUTEUSE HILTI WSJ 850-ET_SCIE SAUTEUSE HILTI WSJ 850-EB_SCIE SAUTEUSE MAKITA DJV180RMJ 44X77MM

RÉF. ART.	DESCRIPTION	LONGUEUR
EL010459	LAME SCIE SAUTEUSE POUR BOIS, PVC, CP À CHANTOURNER L.44MM	L 44 MM

LAMES SCIES SAUTEUSE ALU

 BOSCH



RÉF. ART.	DESCRIPTION
EL020662	T227D

LAMES SCIES SAUTEUSE BOIS

 BOSCH



RÉF. ART.	DESCRIPTION
EL020660	T308BO

LAMES SCIES SAUTEUSE BOIS/METAL

 BOSCH



RÉF. ART.	DESCRIPTION
EL020663	T367XHM

photos non contractuelles

LAMES SCIES SAUTEUSE MATERIAUX FIBREUX

 **BOSCH**



RÉF. ART.	DESCRIPTION
EL020664	T141HM

LAMES SCIES SAUTEUSE T101B

 **BOSCH**



RÉF. ART.
EL020659

LAMES SCIES SAUTEUSE METAL

 **BOSCH**

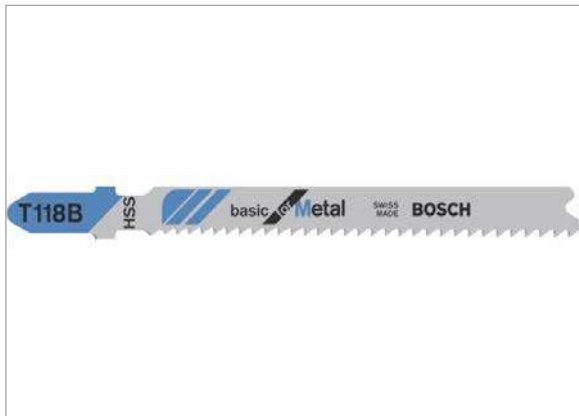

RÉF. ART.	DESCRIPTION
EL020661	T118B

photos non contractuelles

SOUFFLEUR ÉLECTRIQUE FILAIRE DOLMAR EB165V

MAKITA



ASPIRO-SOUFFLEUR 1650W - 11 m³ (2 VITESSES)

RÉF. ART.
EL008674

DECAPEUR GHG 23-66

 **BOSCH**



RÉF. ART.	REFERENCE FABRICANT
EL101538	0.601.2A6.300

SOUFFLEUR THERMIQUE MAKITA PB252- 4

MAKITA



SOUFFLEUR Thermique 4 temps 24,5 cm³ - 10,1 m³/min

RÉF. ART.
EL008675

photos non contractuelles

SCIE STATIONNAIRE À MÉTAUX MAKITA LC1230

MAKITA



1750W - Capacité de coupe (tube acier) 115mm Vitesse à vide 2700 tr/min - Lame Ø305 mm - 19,3 kg - **Fixation obligatoire sur établi ou table**

RÉF. ART.

EL017141

TRONÇONNEUSE 2X18V GUIDE DE 35CM DUC353RF2 MAKITA

MAKITA

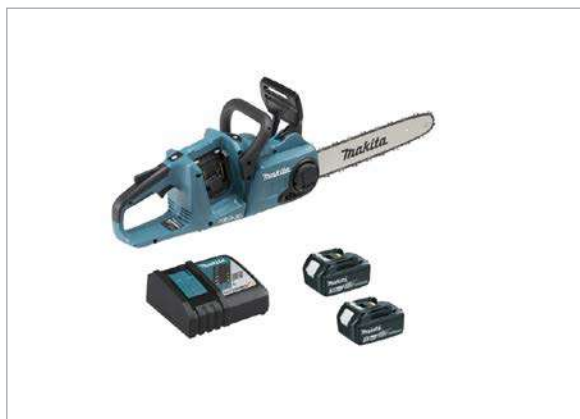

Prévoir EPI spécifiques et individuels - **Nécessite un accord de la Prévention Santé Sécurité**

RÉF. ART.

EL020164

TRONÇONNEUSE THERMIQUE DOLMAR PS500C45

MAKITA



THERMIQUE 2T 50cm³ - 45cm - **Nécessite un accord de la Prévention Santé Sécurité**

RÉF. ART.

EL020845

TRONÇONNEUSE THERMIQUE 2 TEMPS DOLMAR

MAKITA



45,6 cm³ - guide de 45 cm - Prévoir EPI spécifiques et individuels

RÉF. ART.

DESCRIPTION

REFERENCE FABRICANT

EL008507

PS460-45

PS460-45

DECOUPEUSE THERMIQUE / 680ES NUE



RÉF. ART.	REFERENCE FABRICANT
EL107127	576155

DECOUPEUSE THERMIQUE / 680ES + guide + chaîne



RÉF. ART.	DESCRIPTION	REFERENCE FABRICANT
EL112029	Découpeuse 680ES 80cm3 livrée avec 1 guide standard + 1 chaîne F3 30cm	680ES-30

Découpeuse 220V



RÉF. ART.	DESCRIPTION	REFERENCE FABRICANT
EL112038	livrée avec 1 guide 30cm + 1 chaîne F3 25 segments	ESAW-30

DECOUPEUSE K770

HUSQVARNA



RÉF. ART.	DESCRIPTION	REFERENCE FABRICANT
EL106209	SMART GUARD Ø350	970460001

photos non contractuelles

TRONCONNEUSE A CHAINE K970 III CHAIN

HUSQVARNA



RÉF. ART.	DESCRIPTION	REFERENCE FABRICANT
EL106213	(LIVREE SANS GUIDE CHAINE ET SANS CHAINE)	967660501

Une idée de nouveau produit ?



RÉF. ART.	DESCRIPTION
NOUVEAU PRODUIT	mailto:t.bobin@bouygues-construction.com

VERIFIEZ LA DISPONIBILITE DE NOS PRODUITS

DISTRIMO



En scannant le QR code, vérifiez le stock des produits à l'aide des références et de la barre de recherche

RÉF. ART.	DESCRIPTION
SITE WEB	http://distrimo.bouygues-construction.com/

photos non contractuelles

CAPOT ASP. POUR TRONCONNEUSE

HILTI



POUR NOUVELLE 230 PREVOIR CODE 364641

RÉF. ART.	DESCRIPTION	REFERENCE FABRICANT
EL018318	DC-EX 230/9	3582698
EL000477	DC-EX 230/9 - DCG	234435

CHARIOT DE SCIE AU SOL

HILTI



TRONCONNEUSE HILTI DSH 700_TRONCONNEUSE HILTI DSH 900

RÉF. ART.	DESCRIPTION	REFERENCE FABRICANT
EL009776	DSH-FSC	431364

TUBE X-PT 3FT

HILTI



MEULEUSE HILTI DCG 230-DB

RÉF. ART.	DESCRIPTION	REFERENCE FABRICANT
EL019013	CAPOT ASP.POUS (TRONÇ) DC-EX230/9	2156539

COFFRE DE RANGEMENT DSH

HILTI



TRONCONNEUSE HILTI DSH 700_TRONCONNEUSE HILTI DSH 900

RÉF. ART.	REFERENCE FABRICANT
EL003894	365828

photos non contractuelles

COFFRET DCG/DAG 230

HILTI



MEULEUSE HILTI DCG 230-DB

RÉF. ART.	REFERENCE FABRICANT
EL001178	71749

CONVERTISSEUR DPC 20 230V

HILTI



SURFACEUSE HILTI DG 150

RÉF. ART.	PUISSANCE	REFERENCE FABRICANT
EL001449	P 2100 W	369399

ECROU A SERRAGE RAPIDE PLAT

HILTI



RÉF. ART.	REFERENCE FABRICANT
EL002033	2149274

FRAISES LIMES CARBURE HAUTE PERFORMANCE

PFERD

MEULEUSE DROITE FEIN GCZ8-280PEL_MEULEUSE DROITE
FEIN GCZ18-280LBL
KEL 0820/6 ALLROUND

RÉF. ART.	DESCRIPTION
EL020333	KEL 0820/6 ALLROUND
EL020332	SPG 0820/6 ALLROUND
EL020331	ZYAS 0820/6 ALLROUND

MANCHONS ABRASIFS GSB

PFERD



MEULEUSE DROITE FEIN GCZ8-280PEL_MEULEUSE DROITE
FEIN GCZ18-280LBL
GSB 201463 CO-COOL 36

RÉF. ART.	DESCRIPTION
EL020323	MANCHONS ABRASIFS (VENDUS PAR 5) GSB 201463 CO-COOL 36
EL020324	MANCHONS ABRASIFS (VENDUS PAR 5) GSB 201463 CO-COOL 60
EL020325	MANCHONS ABRASIFS (VENDUS PAR 5) GSB 362260 CO-COOL 36
EL020319	1325 CO-COOL 60
EL020320	1925 CO-COOL 36
EL020321	1925 CO-COOL 60
EL020322	6030 CO-COOL 36

KIT ENTRETIEN POUR DECOUPEUSE K770

HUSQVARNA



RÉF. ART.	DESCRIPTION	REFERENCE FABRICANT
EL106210	SMART GUARD (1 BOUGIE + 1 FILTRE + 1 COURROIE)	543106539

RESERVOIR D'EAU SOUS PRESSION 14 LITRES AUTONOME WT2GO

HUSQVARNA



RÉF. ART.	REFERENCE FABRICANT
EL106211	598742401

CHARIOT KV7 POUR DECOUPEUSE K770

HUSQVARNA



RÉF. ART.	DESCRIPTION	REFERENCE FABRICANT
EL106212	SMART GUARD (ADAPTE POUR SCIAGE AU SOL)	587768401

photos non contractuelles

MEULE DIAMANT CYLINDRIQUE POUR FAÏENCE ET CARRELAGE

PFERD



MEULEUSE DROITE FEIN GCZ8-280PEL_MEULEUSE DROITE FEIN GCZ18-280LBL
POUR FAÏENCE ET CARRELAGE

RÉF. ART.	DESCRIPTION
EL020318	MEULE DIAMANT CYLINDRIQUE P/FAÏENCE ET CARRELAGE Ø 6

PINCE DE SERRAGE D.8MM POUR MEULEUSE FEIN AGSZ 18-280 LBL



POUR MEULEUSE EL020167

RÉF. ART.
EL020217

PORTE OUTILS MANCHONS ABRASIFS

PFERD



MEULEUSE DROITE FEIN GCZ8-280PEL_MEULEUSE DROITE FEIN GCZ18-280LBL
GK 1925/6

RÉF. ART.	DESCRIPTION
EL020327	GK 1925/6
EL020328	GK 6030/6
EL020326	GK 1325/6
EL020329	GK 201463/6
EL020330	GK 362260/6

LIME D'AFFÛTAGE POUR CHAÎNE DE TRONÇONNEUSE

SAM OUTILLAGE

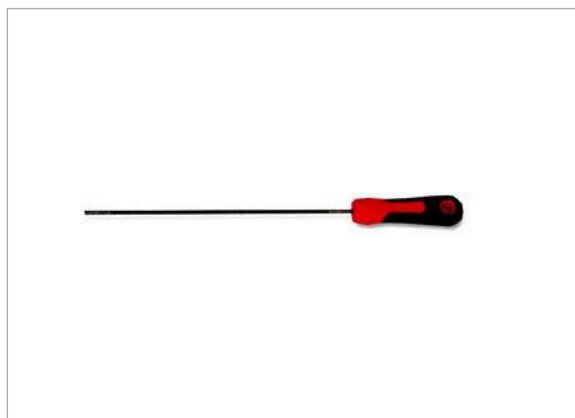

TRONÇONNEUSE ELECTRIQUE DOLMAR ES2140AK_TRONÇONNEUSE THERMIQUE DOLMAR PS460-45

RÉF. ART.	REFERENCE FABRICANT
EL005203	LRT-40-E

DISQUE À TRONÇONNER 300/20

HILTI

RÉF. ART.	DESCRIPTION	REFERENCE FABRICANT
EL019755	DISQUE À TRONÇ. 300/20 P UNIVERSEL	2169812
EL018778	DISQUE À TRONÇ. 300/20 P (6) UNIVERSEL - LOT DE 6	2169813
EL019756	DISQUE À TRONÇ. 300/20 SP UNIVERSEL	2165451
EL018779	DISQUE À TRONÇ. 300/20 SP (6) UNIVERSEL - LOT DE 6	2165452
EL019757	DISQUE À TRONÇ. 300/20 SPX UNIVERSEL	2165457

DISQUE À TRONÇONNER 300/25

HILTI

RÉF. ART.	DESCRIPTION	REFERENCE FABRICANT
EL019758	DISQUE À TRONÇ. 300/25 P UNIVERSEL	2169814
EL018780	DISQUE À TRONÇ. 300/25 P (6) UNIVERSEL - LOT DE 6	2169815
EL019759	DISQUE À TRONÇ. 300/25 SP UNIVERSEL	2165453
EL018781	DISQUE À TRONÇ. 300/25 SP (6) UNIVERSEL	2165454
EL019760	DISQUE À TRONÇ. 300/25 SPX UNIVERSEL	2165459
EL018782	DISQUE À TRONÇ. 300/25 SPX (6) UNIVERSEL - LOT DE 6	2165225
EL019761	DISQUE À TRONÇ. 300/25MM SPX METAL	2200893

DISQUE À TRONÇONNER 350/25

HILTI

RÉF. ART.	DESCRIPTION	REFERENCE FABRICANT
EL019762	DISQUE À TRONÇ. 350/25MM SPX METAL	2200894

DISQUE À TRONÇONNER 400/25

HILTI

RÉF. ART.	DESCRIPTION	REFERENCE FABRICANT
EL019763	DISQUE À TRONÇ. 400/25MM SPX METAL	2200895

photos non contractuelles

DISQUE A TRONÇONNER EQD

HILTI



MEULEUSE HILTI DCG 230-DB

Disque diamant pour tronçonneuses thermiques, meuleuses d'angle et tronçonneuses électriques, pour couper tous types de béton, maçonnerie et autres matériaux

RÉF. ART.	DESCRIPTION	LON- GUEUR	DIAMÈ- TRE	REFERENCE FABRICANT
EL012637	DISQUE A TRONÇ. EQD SPX 230/22 MAÇON	L 22 MM	D 230 MM	2117990
EL012645	DISQUE A TRONÇ. EQD SPX 300/20 DOUX	L 20 MM	D 300 MM	2125440
EL012638	DISQUE A TRONÇ. EQD SPX 300/20 MAÇON	L 20 MM	D 300 MM	2117994
EL012639	DISQUE A TRONÇ. EQD SPX 300/25 MAÇON	L 25 MM	D 300 MM	2117996
EL012628	DISQUE A TRONÇ. EQD SPX 305/22 UNIVERSEL	L 22 MM	D 305 MM	2117966
EL012629	DISQUE A TRONÇ. EQD SPX 350/20 (6) UNIVE LOT DE 6	L 20 MM	D 350 MM	2117973
EL012647	DISQUE A TRONÇ. EQD SPX 350/20 DOUX	L 20 MM	D 350 MM	2125442
EL012641	DISQUE A TRONÇ. EQD SPX 350/20 MAÇON	L 20 MM	D 350 MM	2117998
EL012630	DISQUE A TRONÇ. EQD SPX 350/20 UNIVERSEL	L 20 MM	D 350 MM	2117972
EL012631	DISQUE A TRONÇ. EQD SPX 350/25 UNIVE (LOT DE 6)	L 25 MM	D 350 MM	2117975
EL012648	DISQUE A TRONÇ. EQD SPX 350/25 DOUX	L 25 MM	D 350 MM	2125443
EL012632	DISQUE A TRONÇ. EQD SPX 350/25 UNIVERSEL	L 25 MM	D 350 MM	2117974
EL012634	DISQUE A TRONÇ. EQD SPX 400/20 UNIVERSEL	L 20 MM	D 400 MM	2117976

DISQUE À TRONÇONNER P

HILTI



Lame de coupe segmentée diamantée standard pour scies à gaz, meuleuses d'angle et fraises électriques, pour le découpage de béton, maçonnerie et autres matériaux

RÉF. ART.	DESCRIPTION	DIAMETRE	REFERENCE FAB- RICANT
EL018785	DISQUE À TRONÇ. P 350/20 (6) UNIVERSEL - LOT DE 6		2118707
EL018045	DISQUE À TRONÇ. P 350/20 UNIVERSEL	D 350 MM	2118674
EL018786	DISQUE À TRONÇ. P 350/25 (6) UNIVERSEL - LOT DE 6		2118710
EL018046	DISQUE À TRONÇ. P 350/25 UNIVERSEL	D 350 MM	2118677
EL018048	DISQUE À TRONÇ. P 400/20 UNIVERSEL	D 400 MM	2118675
EL018049	DISQUE À TRONÇ. P 400/25 (6) UNIVERSEL	D 400 MM	2118711
EL018050	DISQUE À TRONÇ. P 400/25 UNIVERSEL	D 400 MM	2118678

DISQUE À TRONÇONNER P-S

HILTI



Lame de coupe segmentée diamantée premium pour scies à gaz, meuleuses d'angle et fraises électriques, pour couper tous types de béton, maçonnerie et autres matériaux

RÉF. ART.	DESCRIPTION	REFERENCE FABRICANT
EL018787	DISQUE À TRONÇ. P-S 230/22.2 UNIVERSEL - LOT DE 6	2118705

photos non contractuelles

DISQUE A TRONÇONNER SP

HILTI



TRONCONNEUSE HILTI DSH 700_TRONCONNEUSE HILTI DSH 900

Lame de coupe segmentée diamantée premium pour scies à gaz, meuleuses d'angle et fraises électriques, pour couper tous types de béton, maçonnerie et autres matériaux

RÉF. ART.	DESCRIPTION	LON- GUEUR	DIAMETRE	REFERENCE FABRICANT
EL012661	DISQUE A TRONÇ. SP 350/20 (6) UNIVERSEL	L 20 MM	D 350 MM	2117897
EL012660	DISQUE A TRONÇ. SP 350/20 UNIVERSEL	L 20 MM	D 350 MM	2117896
EL012663	DISQUE A TRONÇ. SP 350/25 (6) UNIVERSEL	L 25 MM	D 350 MM	2117899
EL012662	DISQUE A TRONÇ. SP 350/25 UNIVERSEL	L 25 MM	D 350 MM	2117898
EL012666	DISQUE A TRONÇ. SP 400/25 UNIVERSEL	L 25 MM	D 400 MM	2117902
EL012672	DISQUE A TRONÇ. SP-S 230/22 UNIVERSEL	L 22 MM	D 230 MM	2117876

DISQUE A TRONÇONNER SPX

HILTI



RÉF. ART.	DESCRIPTION	REFERENCE FABRICANT
EL018747	DISQUE À TRONÇ. SPX 300/20 UNIVERSEL	2165458

DISQUE TRONÇONNER AC-D

HILTI

TRONCONNEUSE HILTI DSH 700

Disque de coupe en acier pour scies à gaz

RÉF. ART.	DESCRIPTION	LON- GUEUR	DIAMÈ- TRE	REFERENCE FABRICANT
EL010416	DISQUE A TRONCONNER AC-D 300x3.5x20 - LOT DE 10	L 20 MM	Ep 03.5 MM D 300 MM	2185967

DISQUE DIAMANT EQD SPX

HILTI



MEULEUSE HILTI DCG 230-DB

Disque diamant pour tronçonneuses thermiques, meuleuses d'angle et tronçonneuses électriques, pour couper tous types de béton, maçonnerie et autres matériaux

RÉF. ART.	DESCRIPTION	LONGUEUR	DIAMETRE	REFERENCE FABRI- CANT
EL010434	230/22 UNIVERSEL	L 22 MM	D 230 MM	2117964
EL020613	VB806			2230397

DISQUE BETON VARI-CUT

HUSQVARNA



RÉF. ART.	DESCRIPTION	REFERENCE FABRICANT
EL106216	S50 350 10 25.4/20	586595502

photos non contractuelles

DISQUE BETON TACTI-CUT

HUSQVARNA



RÉF. ART.	DESCRIPTION	REFERENCE FABRICANT
EL106217	S50 350 10 25.4/20	579816420

DISQUE ASPHALTE VARI-CUT

HUSQVARNA



RÉF. ART.	DESCRIPTION	REFERENCE FABRICANT
EL106218	S85 350 10 25.4/20	579817720

DISQUE ASPHALTE TACTI-CUT

HUSQVARNA



RÉF. ART.	DESCRIPTION	REFERENCE FABRICANT
EL106219	S85 350 10 25.4/20	579816620

CHAINE DOLMAR 3/8

MAKITA



POUR MACHINE PS500C45

RÉF. ART.	DESCRIPTION
EL020846	POUR GUIDE 45CM

CHAINE POUR TRONCONNEUSE EL020164

MAKITA



RÉF. ART.
EL020677

CHAINE TRONCONNEUSE DOLMAR

MAKITA



RÉF. ART.	DESCRIPTION	REFERENCE FABRICANT
EL111700	L40CM 3/8 56 MAILLONS	958492056

photos non contractuelles

CHAINE POUR TRONCONNNEUSE MS250CE 68M 3.25



jusqu'à épuisement

RÉF. ART.

EL005792

CHAINE VARI CHAIN C45 POUR TRONCONNNEUSE K970

HUSQVARNA



RÉF. ART.

EL106215

DESCRIPTION

III CHAIN (POUR BETON DUR ET
MOYENNEMENT DUR ET TENDRE)

REFERENCE FABRI-
CANT

590765501

GUIDE CHAINE POUR TRONCONNNEUSE K9700 III CHAIN 450MM

HUSQVARNA



RÉF. ART.

EL106214

REFERENCE FABRICANT

591152860

GUIDE CHAINE 30CM POUR 680-GC ET CD35



RÉF. ART.

EL107128

REFERENCE FABRICANT

71395

photos non contractuelles

CHAÎNE F3 29 SEGMENTS POUR CD35-613-680 / GC



RÉF. ART.	REFERENCE FABRICANT
EL107129	584290

Guide de chaîne 30 cm pour Découpeuse ESAW-30



RÉF. ART.	REFERENCE FABRICANT
EL112039	612657

Chaîne F3



RÉF. ART.	DESCRIPTION	REFERENCE FABRICANT
EL112040	30cm (25 segments) pour ESAW-814-660/GC	584288

Sac de transport E-SAW



RÉF. ART.	REFERENCE FABRICANT
EL112041	ES30/100

Chaîne F3 Premium



RÉF. ART.	DESCRIPTION	REFERENCE FABRICANT
EL112030	30cm (29 segments) - Béton armé	584298

3 Chaînes F3 Premium



RÉF. ART.	DESCRIPTION	REFERENCE FABRICANT
EL112031	-29 + 1 guide 30cm	P3/680/30FP

Chaîne F3 Brick



RÉF. ART.	DESCRIPTION	REFERENCE FABRICANT
EL112032	30cm (29 segments) - Briques parpn	584297

Carton de 6 flacons d'huile 100ml pour mélange



RÉF. ART.	REFERENCE FABRICANT
EL112033	571229

photos non contractuelles

Cloche d'embrayage 680

RÉF. ART.	REFERENCE FABRICANT
EL112034	71520

Filtre à air pour 680

RÉF. ART.	REFERENCE FABRICANT
EL112035	71752

Lanceur complet pour 680

RÉF. ART.	REFERENCE FABRICANT
EL112036	528637

Embrayage complet pour 680

RÉF. ART.	REFERENCE FABRICANT
EL112037	71419

**TOURNEVIS DOLMAR REGLAGE
CARBURATEUR POUR PS500C45**

MAKITA



POUR PS500C45 DOLMAR

RÉF. ART.
EL020847

**SUR COMMANDE = soumis à des délais
supérieurs à ceux habituels**

SUR COMMANDE = SOUMIS À DES DÉLAIS SUPÉRIEURS À CEUX HABITUELS



RÉF. ART.
SUR COMMANDE

photos non contractuelles

AFFLEUREUSE 3710J

MAKITA



we
life
b
DISTRIPUS

[530W - plage de réglage : 0 à 45° - 1,6kg] - **Nécessite un accord de la Prévention Santé Sécurité**

RÉF. ART.

EL010306

CISAILLE UNIVERSELLE FEIN FILAIRE BSS 2.0E

we
life
b
DISTRIPUS

FEIN - BSS 2.0E - remplace EL020851

RÉF. ART.

EL100580

**COUTEAU OSCILLANT MULTIMASTER
FILAIRE MM 700 MAX TOP FEIN**

SUR COMMANDE
we
life
b
DISTRIPUS

PACK COMPLET sur commande

RÉF. ART.

EL104644

**COUTEAU OSCILLANT MULTIMASTER
SANS FIL AMM 700 MAX TOP FEIN**

SUR COMMANDE
we
life
b
DISTRIPUS

PACK COMPLET sur commande

RÉF. ART.

EL104643

DÉFONCEUSE MAKITA RP1110CJ 1100W

MAKITA



[Profondeur de plongée max. : 57mm - 1100W - 3,4kg] - **Nécessite un accord de la Prévention Santé Sécurité**

Obligatoire avec rail (EL010285) et adaptateur (EL010286)

RÉF. ART.
EL010284

DEFONCEUSE MAKITA RP2300FCXJ 2300W PINCE 12MM

MAKITA



Profondeur de plongée max. 0 à 70 mm - 6,1kg - **Nécessite un accord de la Prévention Santé Sécurité**

RÉF. ART.	PUISSANCE
EL017187	2300W

GRIGNOTEUSE 18V FEIN ABLK 18 1.6 E SELECT - SANS BATTERIE

Permet toute forme de découpe - 18 V - Acier jusqu'à 400 N/mm² 1,6 mm - Acier jusqu'à 600 N/mm² 1,0 mm - Acier jusqu'à 800 N/mm² 0,7 mm - Largeur de coupe 5 mm - 1,6 kg sans la batterie - Machine vendue sans batterie. Prévoir le pack 2 batteries + chargeur EL020218

RÉF. ART.
EL020169

GRIGNOTEUSE FEIN BLK 5

1200 W - Acier jusqu'à 400 N/mm² 5,0 mm - Acier jusqu'à 600 N/mm² 3,3 mm - Acier jusqu'à 800 N/mm² 2,5 mm - Acier inoxydable jusqu'à 2,5 mm - 3,8 kg - Maniabilité : rayon mini (int/ext) 86/94mm

RÉF. ART.
EL020168

photos non contractuelles

LAMELLEUSE VIRUTEX AB111N

VIRUTEX



900w – 10000tr/min – table relevable et inclinable – 3,2kg -
 **Formation renforcée obligatoire ** et **Nécessite un accord de
 la Prévention Santé Sécurité**

RÉF. ART.
 EL017139

**PRESSE À SERTIR ÉLECTROHYDRAULIQUE
KLAUKE EK 120UL 18V**

KLAUKE



Sur batterie 18V – capacité 10 à 400mm² - 6kg

RÉF. ART.
 EL010824

**RABOT MAKITA DKP180RTJ SUR
BATTERIE**

MAKITA



Tension 18V. Profondeur de rabotage 0 à 9MM

RÉF. ART.
 EL018366

RABOT MARKITA KP0810J L.82MM

MAKITA

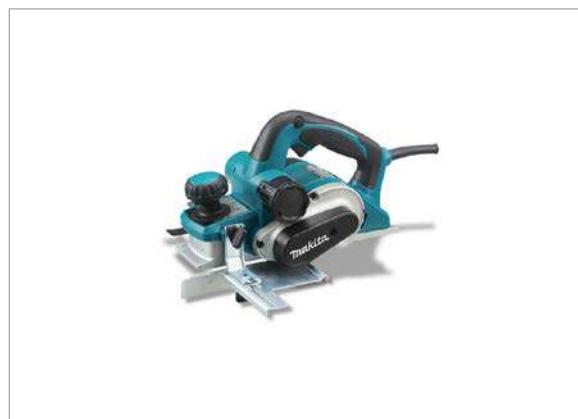

[850 W - LARGEUR 82 mm - 3,3 kg] - PROFONDEUR MAX
 FEUILLURE : 25MM - Branchement aspirateur possible

RÉF. ART.
 EL005352

RABOT FESTOOL HL 850EB-PLUS

FESTOOL



we
life
b
DISTRIPUS

RÉF. ART.	REFERENCE FABRICANT
EL106949	576607

CHANFREINEUSE SANS FIL JUSQU'A 5MM



we
life
b
DISTRIPUS

RÉF. ART.	DESCRIPTION	REFERENCE FABRICANT
EL104645	- Vendu nue	AKFH 18-5 SELECT

SERTISSEUSE ÉLECTROMÉCANIQUE
VIRAX VIPER M21+

virax



we
life
b
DISTRIPUS

14,4V - 20kN - 4,4kg

RÉF. ART.
EL010275

CHANFREINEUSE FILAIRE



SUR COMMANDE
we
life
b
DISTRIPUS

RÉF. ART.	DESCRIPTION	REFERENCE FABRICANT
EL104646	JUSQU'A 15MM KFH 17-15 R	KFH 17-15 R
EL104647	JUSQU'A 8MM KFH 17-8 R	KFH 17-8 R

photos non contractuelles

PERCEUSE MAGNÉTIQUE



prévoir batteries et chargeur https://fein.com/fr_fr/machines/perceage-par-carottage/universel/akbu-35-pmqw-select-71700262000/

RÉF. ART.	DESCRIPTION
EL104727	Ø35MM BATTERIE FEIN AKBU 35 PQW - NU
EL104726	Ø35MM FILAIRE FEIN KBU 35 PQW

GRIGNOTEUSE FILAIRE FEIN



https://fein.com/fr_fr/machines/tronconnage-sciage-et-fraisage/grignoteuses/blk-20-e-72324060000/

RÉF. ART.	DESCRIPTION
EL104720	- 1200W - BLK 2.0 jusqu'à 2mm

CHANFREINEUSE SANS FIL



https://fein.com/fr_fr/machines/tronconnage-sciage-et-fraisage/chanfreineuses/akfh-18-5-71380161000/

RÉF. ART.	DESCRIPTION	REFERENCE FABRICANT
EL104645	JUSQU'A 5MM AKFH 18-5 - Vendu nue	AKFH 18-5

TRANSPORT EXPRESS

LE SERVICE TRANSPORT EXPRESS SUR MESURE VOUS ASSURE L'ENLÈVEMENT ET LA LIVRAISON DE COLIS, PLANS, PALETTES ET HORS-GABARIT DANS LES DÉLAIS LES PLUS COURTS.



RÉF. ART.	DESCRIPTION
Transport express	L.BONAVENTURE@bouygues-construction.com j.imboden@bouygues-construction.com

photos non contractuelles

CHARGEUR 4 BATTERIES DC18SF

MAKITA



PERFO BURINEUR DHR243RMJV_VISSEUSE A CHOC MAKITA DTD154RTJ_PONCEUSE MAKITA DBO180RMJ_CISAILLE MAKITA DJS161RMJ_SCIE CIRCULAIRE MAKITA DHS630RMJ_SCIE SAUTEUSE MAKITA DJV180RMJ_RABOT MAKITA DK-P180RMJ_COUTEAU OSCILLANT MAKITA TM3010CX1J_PIS-TOLET ELECTRIQUE A SILICONE MAKITA_ASPIRATEUR MAKITA DVC350Z_ASPIRATEUR MAKITA DVC860LZ_ASPIRATEUR MAKITA DVC260Z

CHARGEUR 4 BATTERIES DC18SF POUR BATTERIES 18V

RÉF. ART.	DESCRIPTION	REFERENCE FABRICANT
EL010446	POUR BATTERIES 18V	196426-3

CHARGEUR RAPIDE POUR BATTERIE DC18RC MAKITA

MAKITA



PERFO BURINEUR DHR243RMJV_VISSEUSE A CHOC MAKITA DTD154RTJ_PONCEUSE MAKITA DBO180RMJ_CISAILLE MAKITA DJS161RMJ_SCIE CIRCULAIRE MAKITA DHS630RMJ_SCIE SAUTEUSE MAKITA DJV180RMJ_RABOT MAKITA DK-P180RMJ_COUTEAU OSCILLANT MAKITA TM3010CX1J_PIS-TOLET ELECTRIQUE A SILICONE MAKITA_ASPIRATEUR MAKITA DVC350Z_ASPIRATEUR MAKITA DVC860LZ_ASPIRATEUR MAKITA DVC260Z

CHARGEUR RAPIDE DC18RC POUR BATTERIE 18V

RÉF. ART.	DESCRIPTION	REFERENCE FABRICANT
EL010444	CHARGEUR RAPIDE POUR BATTERIE LI-ION NI-MH 9,6-18V DC18RC MAKITA	195584-2

PACK 2 BATTERIES 5,5 H PROCORE + 1 CHARGEUR

RÉF. ART.	REFERENCE FABRICANT
EL102296	1600A0214C

BATTERIE GBA 18 V EN 5,5 AH PROCORE

RÉF. ART.	REFERENCE FABRICANT
EL102297	1600A02149

photos non contractuelles

CHARIOT DIABLE MAKITA TRANSPORT COFFRETS MACPAC EMPILABLES

MAKITA

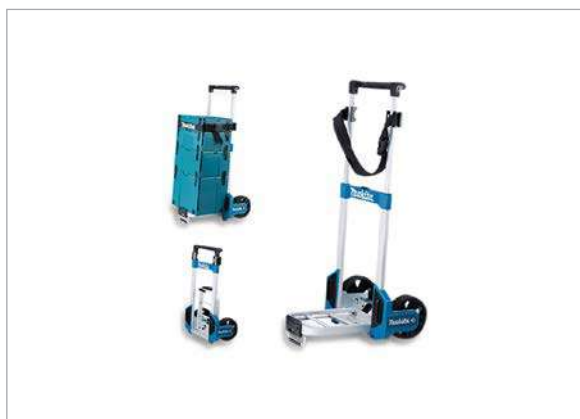

we
life

CHARIOT DIABLE MAKITA TRANSPORT COFFRETS EMPILABLES POUR COFFRETS TYPE MACPAC AVEC POGNEE RETRACTABLE ET PLATEAU PLIABLE

RÉF. ART.

EL010869

DIABLE REPLIABLE

 BOSCH



RÉF. ART.

EL101530

REFERENCE FABRICANT

1600A0015A

ADAPTATEUR DE DOUILLE ½ - POUR ASCM18



RÉF. ART.

EL104902

ADAPTATEUR DE TARAUDAGE - POUR ASCM18



RÉF. ART.

EL104901

ADAPTATEUR SCIE CLOCHE - POUR ASCM18



RÉF. ART.
EL104899

ADAPTATEUR REGLE DE GUIDAGE POUR RP110CJ MAKITA

MAKITA



DEFONCEUSE MAKITA RP110CJ

RÉF. ART.
EL010286

BANDE ABRASIVE CÉRAMIQUE LG.



RÉF. ART.	DESCRIPTION
EL104861	520MM LARG. 20 GR.80 -BF10-280E
EL104856	520MM LARG. 3 GR.120 -BF10-280E
EL104857	520MM LARG. 3 GR.180 -BF10-280E
EL104855	520MM LARG. 3 GR.80 -BF10-280E
EL104859	520MM LARG. 6 GR.120 -BF10-280E
EL104860	520MM LARG. 6 GR.180 -BF10-280E
EL104858	520MM LARG. 6 GR.80 -BF10-280E
EL104862	520MM LARG.20 GR.120 -BF10-280E
EL104863	520MM LARG.20 GR.180 -BF10-280E

BANDE FIBRE



DOUCE POUR LES SURFACES LISSES

RÉF. ART.	DESCRIPTION
EL104869	, LG. 520MM LARG. 20 TEXTURE FINE -BF10-280E
EL104867	, LG. 520MM LARG. 20 TEXTURE GROSSIÈRE -BF10-280E
EL104868	, LG. 520MM LARG. 20 TEXTURE MOY-BF10-280E
EL104866	, LG. 520MM LARG. 6 TEXTURE FINE -BF10-280E
EL104864	, LG. 520MM LARG. 6 TEXTURE GROSSIÈRE -BF10-280E
EL104865	, LG. 520MM LARG. 6 TEXTURE MOY-BF10-280E

photos non contractuelles

BANDE POLISSAGE



RÉF. ART.	DESCRIPTION
EL104871	LONGUEUR 520 MM LARGEUR 20 - POUR BF10-280E
EL104870	LONGUEUR 520 MM LARGEUR 6 - POUR BF10-280E

BEST OF STARLOCK



RÉF. ART.	DESCRIPTION
EL104893	MÉTAL (5 LAMES ET 1 LAME SCIE - PR 700 TOP
EL104894	PONÇAGE - POUR 700 TOP
EL104895	RÉNOVATION - POUR 700 TOP

BEST OF E-CUT STARLOCK



RÉF. ART.	DESCRIPTION
EL104890	BOIS/MÉTAL (6 LAMES) - POUR 700 TOP
EL104891	MAX BOIS/MÉTAL (6 LAMES) - PR 700 TOP
EL104892	PLUS BOIS/MÉTAL (6 LAMES) - PR 700 TOP

BRAS DE PONÇAGE DROIT



POUR BF10-280E

RÉF. ART.	DESCRIPTION
EL104854	LARGEUR BANDE 20 MM - POUR BF10-280E
EL104853	LARGEUR BANDE 6MM - POUR BF10-280E

BRAS PONÇAGE À MOYEU DÉPORTÉ



POUR BF10-280E

RÉF. ART.	DESCRIPTION
EL104852	LARGEUR BANDE 3/6 MM - B10-280E

COUTEAU COURBE POUR TÔLE



RÉF. ART.	DESCRIPTION
EL104874	COUTEAU COURBE PR TÔLE 400N/MM2. EP. TÔLE 1 MM -ABSS 18 1,6E

COFFRET DE FRAISES WELDON



7 FRAISES Ø 12,14,16,18,20,22 MM ET 2 ÉJECTEURS

RÉF. ART.	DESCRIPTION
EL104888	¾, PROF. 25 MM - POUR "A"KBU35
EL104887	¾, PROF. 50 MM - POUR "A"KBU35

COUTEAU POUR INOX



RÉF. ART.	DESCRIPTION
EL104873	COUTEAU PR INOX 800N/MM2. EP. TÔLE 0,8MM -ABSS 18 1,6E

photos non contractuelles

COUPEAU POUR TÔLE



RÉF. ART.	DESCRIPTION
EL104875	COUPEAU PR TÔLE 400N/MM2. EP. TÔLE 1,6MM -ABSS 18 1,6E

MANDRIN DE PERÇAGE



RÉF. ART.	DESCRIPTION
EL104900	120NM - POUR ASCM18
EL104903	60NM - POUR ASCM18
EL104897	SKE - POUR ASCM18

GALET DE GUIDAGE



Ø 28,55 mm pour un chanfrein de 45 ° et un rayon de 3 mm.

RÉF. ART.	DESCRIPTION
EL104914	POUR KFH17-15R
EL104904	Ø 21,69 MM - POUR AKFH 18-5 SELECT
EL104909	Ø 29,90 MM PR CHANFREIN DE 30° JUSQU'À 15MM
EL104913	GALET GUIDAGE Ø 26,30MM POUR CHANFREIN 45° JUSQU'À 15 MM

MATRICE POUR TÔLE ACIER



RÉF. ART.	DESCRIPTION
EL104882	MATRICE ALU JUSQU'À 7MM, TÔLE ACIER JUSQU'À 5 MM - POUR BLK5

MATRICE POUR ABLK 1.6



RÉF. ART.	DESCRIPTION
EL104885	MATRICE POUR "A"BLK 1.6 (PACK DE 5)
EL104884	MATRICE POUR "A"BLK 1.6 (UNITÉ)

MATRICE POUR TÔLE



RÉF. ART.	DESCRIPTION
EL104880	JUSQU'À 5MM D'ÉPAISSEUR - POUR BLK5

MATRICE POUR TÔLE ACIER



RÉF. ART.	DESCRIPTION
EL104881	JUSQU'À 3 MM - POUR BLK5

PAIRE DE MORS - POUR ABSS



RÉF. ART.	DESCRIPTION
EL104872	18 1.6E (EL104716)
EL1048772	18 1.6E (EL104716) FEIn

photos non contractuelles

PLAQUE À VENTOUSES POUR MATÉRIAUX MAGNÉTIQUES



250X330X110 MM

RÉF. ART.	DESCRIPTION
EL104889	POUR "A"KBU35

PLAQUETTES RÉVERSIBLES CHANFREIN



SUR ACIER ET ACIER INOXYDABLE - LOT de 10

RÉF. ART.	DESCRIPTION
EL104905	5MM -PR AKFH 18-5 SELECT

PLAQUETTES RÉVERSIBLES KX



Chanfrein pour métaux non ferreux et matériaux souples (aluminium, cuivre, plastiques...) pour KFH17-15R

RÉF. ART.	DESCRIPTION
EL104915	CHANFREIN DE 5 MM - POUR KFH17-15R
EL104916	RAYON DE 3MM - POUR KFH17-15R
EL104911	SUR ACIERS ET ACIERS INOXYDABLES
EL104910	SUR MÉTAUX NON FERREUX ET TENDRES

PLAQUETTES RÉVERSIBLES



SUR ACIER ET ACIER INOXYDABLE - LOT de 11

RÉF. ART.	DESCRIPTION
EL104906	RAYON 2,5MM - PR AKFH 18-5 SELECT

POINÇON ACIER



RÉF. ART.	DESCRIPTION
EL104879	JUSQU'À 3MM - POUR BLK5

POINÇON POUR "A"BLK 1.6



RÉF. ART.	DESCRIPTION
EL104883	(UNITÉ)

PORTE EMBOUT ¼



RÉF. ART.	DESCRIPTION
EL104898	- POUR ASCM18

POINÇON TÔLE ALU



RÉF. ART.	DESCRIPTION
EL104878	JUSQU'À 7 MM ACIER JUSQU'À 5 MM - PR BLK5

PORTE-PLAQUETTES



RÉF. ART.	DESCRIPTION
EL104912	PORTE PLAQUETTES - POUR KFH17-15R
EL104908	30° POUR KFH 17-15 R - POUR KFH17-15R

photos non contractuelles

REGLE DE GUIDAGE POUR DEFONCEUSE MAKITA

MAKITA

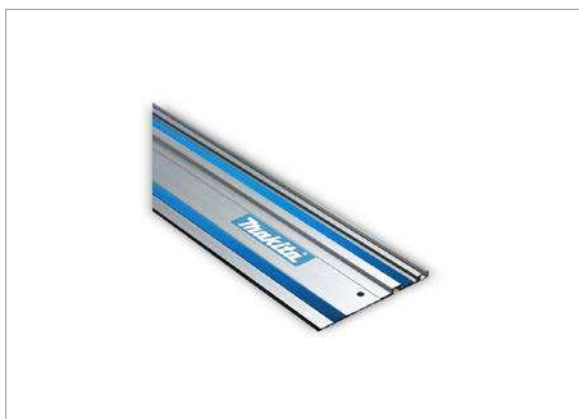

DEFONCEUSE MAKITA RP1110CJ
POUR DEFONCEUSE DJV180/DHS630/RP1110CJ

RÉF. ART.	DESCRIPTION
EL010285	REGLE DE GUIDAGE L.1400MM POUR DEFONCEUSE MAKITA

SET DE DÉMARRAGE 18V



(2 BATTERIES ET 1 CHARGEUR ALG 80)

RÉF. ART.	DESCRIPTION
EL104849	3A (2 BATTERIES ET 1 CHARGEUR ALG 80)
EL104851	5,2A HIGHPOWER (2 BATT + CHARG ALG 80)
EL104850	6A (2 BATTERIES ET 1 CHARGEUR ALG 80)

RENOI D'ANGLE - POUR ASCM18



RÉF. ART.
EL104896

SET POINÇON ET MATRICE : TÔLE D'ACIER



COMPRENANT 1 POINÇON ET 1 MATRICE - 400 N/MM2

RÉF. ART.	DESCRIPTION
EL104876	JUSQU'À 5 MM - PR BLK5
EL104877	JUSQU'À 6 MM - PR BLK5

SET POINÇON ET MATRICE POUR "A"BLK 1.6



(COMPREND 1 POINÇON ET 1 MATRICE)

RÉF. ART.

EL104886

VIS DE FIXATION POUR PLAQUETTES SX



RÉF. ART. DESCRIPTION

EL104907 - POUR AKFH 18-5 SELECT

EL104917 - POUR KFH17-15R

Une idée de nouveau produit ?



RÉF. ART. DESCRIPTION

NOUVEAU PRODUIT mailto:t.bobin@bouygues-construction.com

VERIFIEZ LA DISPONIBILITE DE NOS PRODUITS

DISTRIMO



En scannant le QR code, vérifiez le stock des produits à l'aide des références et de la barre de recherche

RÉF. ART. DESCRIPTION

SITE WEB <http://distrimo.bouygues-construction.com/>

photos non contractuelles

ACCESSOIRES BOIS/PARQUET POUR COUTEAUX OCCILLANTS MAKITA

MAKITA



COUTEAU OSCILLANT MAKITA DTM51RFJX3_COUTEAU OSCILLANT MAKITA TM3010CX1J
ADAPTABLE SUR COUTEAUX OSCILLANTS MAKITA, 2 lames plongeantes, 1 spatule et 1 lame segment

RÉF. ART.

EL008681

ASSORTIMENT ABRASIFS BOIS DELTA PR COUTEAU OSCILLANT MAKITA

MAKITA



COUTEAU OSCILLANT MAKITA DTM51RFJX3_COUTEAU OSCILLANT MAKITA TM3010CX1J
ASSORTIMENT ABRASIFS DELTA POUR COUTEAU OSCILLANT POUR BOIS (5X2 FEUILLES)

RÉF. ART.

EL010481

ACCESSOIRES CARRELAGE POUR COUTEAUX OCCILLANTS MAKITA

MAKITA



COUTEAU OSCILLANT MAKITA DTM51RFJX3_COUTEAU OSCILLANT MAKITA TM3010CX1J
ADAPTABLE SUR COUTEAUX OSCILLANTS MAKITA, 1 lame plongeante, 1 spatule, 1 lame segment et 1 plateau de ponçage

RÉF. ART.

EL008682

COFFRE FRAISES A ARASER ET DE BORDAGE



RÉF. ART.

EL020658

DESCRIPTION

COFFRET DE 6 FRAISES 8 mm

photos non contractuelles

COFFRET FRAISES À RAINURER DROITE

ISOCELE



DEFONCEUSE MAKITA RP1110CJ
COFFRET DE 10 FRAISES A RAINURER DROITE QUEUE 8MM -
ISOCELE-LEMAN

RÉF. ART.	DESCRIPTION
EL001179	COFFRET 10 FRAISES À RAINURER DROITE QUEUE DE 8MM
EL001181	COFFRET FRAISES QUEUE DE L.8MM, 20 PIÈCES
EL001182	COFFRET FRAISES QUEUE DE L.8MM, 30 PIÈCES
EL001183	COFFRET FRAISES QUEUE DE L.8MM, 66 PIÈCES

**COUTEAU À SEGMENTMOQUETTE PR
COUTEAU OSCILLANT MAKITA**

MAKITA



COUTEAU OSCILLANT MAKITA DTM51RFJX3_COUTEAU OS-
CILLANT MAKITA TM3010CX1J
COUTEAU A SEGMENT 100 MOQUETTE POUR COUTEAU
OSCILLANT 100MM MATERIAUX CAOUTCHOUC

RÉF. ART.	DESCRIPTION
EL010483	COUTEAU À SEGMENT 100MM MOQUETTE PR COUTEAU OSCILLANT MAKITA

FERS POUR RABOTS

MAKITA



RABOT MAKITA DKP180RMJ_RABOT MAKITA KP0810J
Plaquettes réversibles - Compatibles KPO810J-DKP180RMJ

RÉF. ART.	DESCRIPTION
EL008686	L.82MM COMPATIBLES KPO810J-DKP180RMJ MAKITA

FRAISE DROITE

MAKITA



AFFLEUREUSE MAKITA 3710J
FRAISE DROITE AFFLEUREUSE QUEUE DE 6 POUR 3710J

RÉF. ART.	DESCRIPTION
EL010490	AFFLEUREUSE, QUEUE DE 6 MM POUR 3710J
EL010488	Q8 D24 P25,4 FL2

photos non contractuelles

LAME COUPANTE CIRCULAIRE

MAKITA



COUTEAU OSCILLANT MAKITA DTM51RFJX3_COUTEAU OS-
CILLANT MAKITA TM3010CX1J
LAME COUPANTE CIRCULAIRE 85 POUR COUTEAU OSCIL-
LANT Ø85MM POUR METAL-BOIS

RÉF. ART.	DESCRIPTION	DIAMETRE
EL010472	LAME COUPANTE CIRCULAIRE D.85MM POUR COUTEAU OSCILLANT MAKITA	D 85 MM
EL010471	D.65MM PR COUTEAU OSCILLANT MAKITA	D 65 MM

LAME COUPE JOINT UNIVERSELLE POUR COUTEAU OSCILLANT MAKITA

MAKITA



COUTEAU OSCILLANT MAKITA DTM51RFJX3_COUTEAU OS-
CILLANT MAKITA TM3010CX1J
LAME COUPE JOINT UNIVERSELLE POUR COUTEAU OSCIL-
LANT 28X50MM JOINTS-MASTIC

RÉF. ART.	LONGUEUR
EL010479	L 28 MM

LAME E-CUT BI-METAL CARBURE 32 MM PR COUTEAU OSCILLANT FEIN

pour découpe métal avec traitement carbure pour qualité supé-
rieure

RÉF. ART.
EL020200

LAME PLONGEANTE DROITE POUR COUTEAU OSCILLANT MAKITA

MAKITA

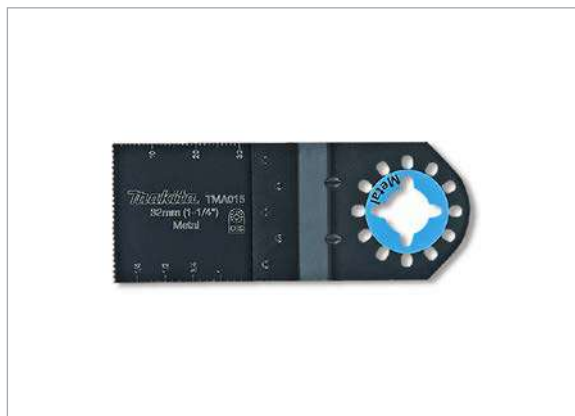

COUTEAU OSCILLANT MAKITA DTM51RFJX3_COUTEAU OS-
CILLANT MAKITA TM3010CX1J
20X20MM BOIS-CLOUS-CUIVRE

RÉF. ART.	DESCRIPTION	LONGUEUR
EL010475	L.20MM	L 20 MM
EL010473	L.28MM	L 28 MM
EL010474	L.32MM	L 32 MM

photos non contractuelles

LAME PLONGEANTE FIBRE DE VERRE PR COUTEAU OSC. MAKITA

MAKITA



COUTEAU OSCILLANT MAKITA DTM51RFJX3_COUTEAU OS-
CILLANT MAKITA TM3010CX1J
32X30MM FIBRE- JOINT CARRELAGE

RÉF. ART.	DESCRIPTION	LONGUEUR
EL010482	L.32MM	L 32 MM

LAMES SCIE CIRCULAIRE HSS POUR COUTEAU OSCILLANT FEIN



diam. 100mm, pour découpe de tôle jusqu'à 1mm d'épaisseur,
pour découpe plastique, carbone et bois

RÉF. ART.
EL020202

LAME SEGMENT ONDULÉE POUR COUTEAU OSCILLANT MAKITA

MAKITA



COUTEAU OSCILLANT MAKITA DTM51RFJX3_COUTEAU OS-
CILLANT MAKITA TM3010CX1J
LAME SEGMENT ONDULEE 100 POUR COUTEAU OSCILLANT
100MM - MATERIAUX ISOLANTS

RÉF. ART.	DESCRIPTION	LONGUEUR
EL010478	L.100MM	L 100 MM

PLATEAU DE PONÇAGE PR COUTEAU OSCILLANT MAKITA

MAKITA



COUTEAU OSCILLANT MAKITA DTM51RFJX3_COUTEAU OS-
CILLANT MAKITA TM3010CX1J
PLATEAU PONCAGE CARBURE 78 G30 POUR COUTEAU OS-
CILLANT GRAIN 30 MORTIER-COLLE

RÉF. ART.	DESCRIPTION
EL010480	L.78MM

photos non contractuelles

POINCON ET MATRICE POUR GRIGNOTEUSE FEIN ABLK E Select



POUR GRIGNOTEUSE EL020169

RÉF. ART.

EL020197

POINCON ET MATRICE POUR GRIGNOTEUSE FEIN BLK 5



POUR GRIGNOTEUSE EL020168

RÉF. ART.

EL020199

SET 3 LAMES SCIE E-CUT UNIVERSEL PR COUPEAU OSCILLANT FEIN



pour découpe bois jusqu'à 50mm, tôle jusqu'à 2mm, alu, acier, cuivre plastique

RÉF. ART.

EL020201

SPATULE FLEXIBLE POUR COUPEAU OSCILLANT MAKITA

MAKITA



COUPEAU OSCILLANT MAKITA DTM51RFJX3_COUPEAU OSCILLANT MAKITA TM3010CX1J
SPATULE FLEXIBLE 52 POUR COUPEAU OSCILLANT 52X38MM JOINTS-COLLE

RÉF. ART.

DESCRIPTION

EL010477

L.52MM L.38MM

SPATULE RACLAGE RIGIDE PR COUTEAU OSCILLANT MAKITA

MAKITA



COUTEAU OSCILLANT MAKITA DTM51RFJX3_COUTEAU OSCILLANT MAKITA TM3010CX1J
SPATULE RACLAGE RIGIDE 52 POUR COUTEAU OSCILLANT 52X26MM MORTIER-COLLE

RÉF. ART.	DESCRIPTION
EL010476	L.52MM

SUR COMMANDE = soumis à des délais supérieurs à ceux habituels

SUR COMMANDE = SOUMIS À DES DÉLAIS SUPÉRIEURS À CEUX HABITUELS



RÉF. ART.
SUR COMMANDE

PATE DE COUPE



RÉF. ART.	REFERENCE FABRICANT
EL020198	32132020129

photos non contractuelles

KIT VISSEUSE SF2

HILTI

we ♥
life
b
DISTRIPUS

Perceuse visseuse sans fil compacte et mandrin autoserrant 10 mm, pour charges faibles et moyennes + B22 5.2AH + CHARGEUR C4/36

RÉF. ART.	DESCRIPTION	REFERENCE FABRICANT
EL017397	(+2 B 12/2.6 +ADAPT CA-B12 +CONSO)	3566449

KIT VISSEUSE SF 4

HILTI

RÉF. ART.	DESCRIPTION
EL111672	(+ 2 B22/2.6)

TOURNEVIS SUR BATTERIE MAKITA TD022DSEX 7,2v

MAKITA



we ♥
life
b
DISTRIPUS

Batterie 7,2 V - Vitesse max.2450 tr/min - Cadence chocs 3000 coups/min Couple maxi 25Nm - 0,56 kg

RÉF. ART.
EL009924

VISSEUSE À CHOC MAKITA DTD154RJ SUR BATTERIE 18V/4A

MAKITA



we ♥
life
b
DISTRIPUS

Sur batterie - 18V / 5Ah / 175Nm

RÉF. ART.
EL009925

BOULONNEUSE 1630NM 3/4 "

MAKITA



we ♥
life
b
DISTRIPUS

RÉF. ART.	DESCRIPTION	REFERENCE FABRICANT
EL101011	40VMAX BL4040X2 DC40RA	TW001GM201

photos non contractuelles

VISSEUSE À CHARGEUR HH80B

ALSAFIX



Spéciale filière bois - Visseuse à chargeur HH80B vis en rouleau de 40 à 80MM avec chargeur et une batterie

RÉF. ART.	DESCRIPTION	REFERENCE FABRICANT
EL018193	VIS EN ROULEAU DE 40 À 80MM	HH80B

VISSEUSE GSR 18V-110 C

BOSCH



RÉF. ART.	REFERENCE FABRICANT
EL101523	06019G010A

VISSEUSE A CHOC GDR 18V-200 C

BOSCH



RÉF. ART.	REFERENCE FABRICANT
EL101524	06019G4101

VISSEUSE GSR 18V-110 C - NUE

BOSCH



RÉF. ART.	REFERENCE FABRICANT
EL102289	06019G0109

photos non contractuelles

BATTERIE LI-ION 18V 4AH MAKITA

MAKITA



VISSEUSE A CHOC MAKITA DTD154RTJ_PONCEUSE MAKITA DBO180RMJ_CISAILLE MAKITA DJS161RMJ_SCIE CIRCULAIRE MAKITA DHS630RMJ_SCIE SAUTEUSE MAKITA DJV180RMJ_RABOT MAKITA DKP180RMJ_COUTEAU OSCILLANT MAKITA TM3010CX1J_ASPIRATEUR MAKITA DVC350Z_ASPIRATEUR MAKITA DVC860LZ_ASPIRATEUR MAKITA DVC260Z BATTERIE 18V 4AH LI-ION

RÉF. ART.	DESCRIPTION
EL010443	
EL010447	BATTERIE LI-ION 18V 5AH MAKITA

PACK 2 BATTERIES 6Ah

MAKITA



RÉF. ART.	DESCRIPTION	REFERENCE FABRICANT
EL111966	PLUS UN CHARGEUR DC18RC	198116-4

CHARGEUR DOUBLE DC18RD

MAKITA



RÉF. ART.	REFERENCE FABRICANT
EL111967	196933-6

PACK 4 BATTERIES 5AH, CHARGEUR DBLE POUR TOUTES MACHINES 18V

MAKITA



PERFO BURINEUR DHR243RMJV_VISSEUSE A CHOC MAKITA DTD154RTJ
PACK 4 BATTERIES 5Ah + CHARGEUR DOUBLE POUR TOUTES MACHINES 18V - MAKITA

RÉF. ART.
EL010331

Kit ProCORE 18V (2 x 8,0Ah + GAL 18V-160)

 **BOSCH**



RÉF. ART.	REFERENCE FABRICANT
EL106815	1600A016GP

Batterie 18V 8,0Ah ProCORE

 **BOSCH**



RÉF. ART.	REFERENCE FABRICANT
EL106816	1600A016GK

Chargeur GAL 18V-160 C

 **BOSCH**



RÉF. ART.	REFERENCE FABRICANT
EL106817	1600A019S5

BATTERIE 18V 5,0AH LI-ION POUR HH80B

 **ALSAFER**



VISSEUSE A CHARGER HH80B
pour EL019193

RÉF. ART.	REFERENCE FABRICANT
EL020244	DDF481RTE

photos non contractuelles

RALLONGE POUR VISSEUSE HH80B ADAPTABLE VISSEUSE A ROULEAU

ALSAFIX



VISSEUSE A CHARGER HH80B
Rallonge pour visseuse HH80B adaptable sur visseuse à rouleau HH

RÉF. ART.
EL018196

Bloc accu B 14/2.6

HILTI



RÉF. ART.	DESCRIPTION	REFERENCE FABRICANT
EL105345	- UNITE	2189547

BLOC ACCU B12/2.6

HILTI



RÉF. ART.	DESCRIPTION	REFERENCE FABRICANT
EL020246		2077976
EL020626	BLOC ACCU B14/5.2 LION	2193380

CHARGEUR D'ACCU

HILTI

RÉF. ART.	DESCRIPTION	REFERENCE FABRICANT
EL020247	C4/12 50 230V BOITE	2076993
EL008584	C4/36 - 350 230V BT	2028875
EL009108	C4/36-90 230V	2015761
EL004993	C7/36-ACS 230V	378452

LAMPE SANS FIL

HILTI



RÉF. ART.	DESCRIPTION	REFERENCE FABRICANT
EL010186	SFL 22-A	2163830
EL020544	SL 2-A12 BOÎ	2163831

photos non contractuelles

TUBE PROLONGATEUR SME

HILTI

AUTRE VISSEUSE HILTI

RÉF. ART.	REFERENCE FABRICANT
EL004550	304495

BATTERIE 18V 4,0AH LITHIUM

spit

VISSEUSE SDI 186 SPIT_VISSEUSE HDI 186 SPIT

RÉF. ART.	REFERENCE FABRICANT
EL006675	54393

ADAPT. SPEED P55 EASY CLICK POUR P18

spit

VISSEUSE SPIT P18

RÉF. ART.	REFERENCE FABRICANT
EL017751	54626

BATTERIE 328 28V 4.2AH LITHIUM

spit

PERFORATEUR 328 SPIT

RÉF. ART.	REFERENCE FABRICANT
EL010688	54462

photos non contractuelles

BATTERIE P18 LI 18V 4.2AH



VISSEUSE SPIT P18 LI

RÉF. ART.	REFERENCE FABRICANT
EL017753	54624

BATTERIE POUR IM90CI



RÉF. ART.	REFERENCE FABRICANT
EL018553	18881
EL010796	18880 -

CHARGEUR BATTERIES LITHIUM



VISSEUSE SDI 145 VISSEUSE HDI 286 SPIT_VISSEUSE SDI 186
SPIT_VISSEUSE SDI 105 SPIT_VISSEUSE SDI 115 SPIT_VIS-
SEUSE HDI 246 SPIT_VISSEUSE IDI 246 SPIT_VISSEUSE 217
SPIT

RÉF. ART.	REFERENCE FABRICANT
EL006653	54286

CHARGEUR P18 LI 18V



VISSEUSE SPIT P18 LI

RÉF. ART.	REFERENCE FABRICANT
EL017754	54625

PERCHE EX P580 VISSEUSE P18

SPIT



VISSEUSE SPIT P18

RÉF. ART.	REFERENCE FABRICANT
EL017750	54627

ERGO'APP

PÔLE ERGO BYCN

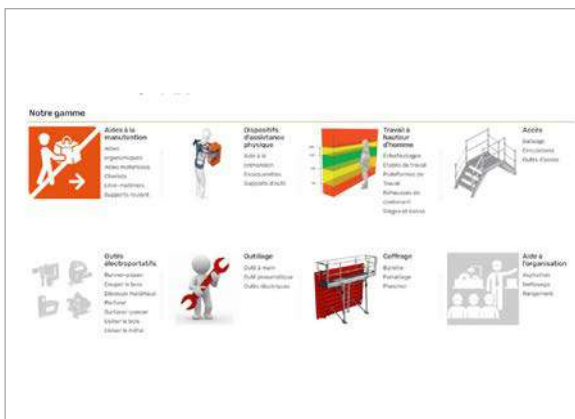

Outil d'aide à la décision permettant d'aider les collaborateurs à choisir les meilleurs outils, matériels ou matériaux selon un besoin et un contexte. Pour chaque produit, l'app propose une carte d'identité détaillée (caractéristiques techniques, photos, liens utiles) et précise pour quel type de tâches il est destiné. Evaluation sur la base de 5 critères : Amélioration de la sécurité, Apport sur la santé, Gain de productivité Intuitivité Poids < 15 kg

RÉF. ART.	DESCRIPTION
ERGO'APP	https://ergoapp.bouygues-construction.com/?lang=fr

BYTROC

APP INTERNE BYCN



Flashez le QR code pour découvrir en détail le service ou bien : <https://bycnmateriel.odoo.com/montage-mobilier>

RÉF. ART.	DESCRIPTION
BYTROC	Annonces de recherche, vente et/ou troc de matériel, matériaux et équipements dont les chantiers BYCN n'ont plus l'utilité.

COFFRET D'ACCESSOIRES, 71 PIÈCES

MAKITA



COFFRET ENSEMBLE ACCESSOIRES 71 PIECES VISSAGE ET PERCAGE

RÉF. ART.

CO010508

COFFRET EMBOUTS DE VISSAGE ET FORETS
 **BOSCH**

RÉF. ART.

EL020657

COFFRET D'EMBOUTS 38 PIECES + PORTE-EMBOUT MAGNÉTIQUE

MAKITA



COFFRET EMBOUTS 38 PIECES + PORTE-EMBOUT MAGNETIQUE + TOURNEVIS PORTE-EMBOUT

RÉF. ART.

CO010497

COFFRET VISSAGE BOULONNAGE 47 PIÈCES

MAKITA



RÉF. ART.

CO010484

EMBOUT TORX POUR HH80B ADAPTABLE SUR VISSEUSE HH80B M6 DE 25



VISSEUSE A CHARGER HH80B

RÉF. ART.

EL018197

VIS EN ROULEAU 5X80 GALVA TX25 POUR HH80B DE 40 À 80MM



VISSEUSE A CHARGER HH80B

RÉF. ART.

EL018195

ANNEAU 3/4



RÉF. ART.	DESCRIPTION	REFERENCE FABRICANT
EL018758	17MM-49MM JEU	2097738

BOITE D'EMBOUTS S-BSC



PERCEUSE HILTI UD30 _PERCEUSE HILTI SFH 22-A _PERCEUSE SPIT IDI 246 _VISSEUSE HILTI SF 14-A _VISSEUSE HILTI SFC 14-A _VISSEUSE HILTI SFC 22-A _VISSEUSE SPIT HDI 286

RÉF. ART.	DESCRIPTION	REFERENCE FABRICANT
EL017990	BOITE D'EMBOUTS S-BSC UNI 50/2 T (6) BUL	2057803
EL008956	+ PH 25/1 (10) HILTI	2039184
EL000233	PH 25/1 T (7) HILTI	2038638
EL000234	PZ 25/1 T (7) HILTI	2038639
EL000235	TX 25/1 T (7) HILTI	2039170

photos non contractuelles

BOITE D'EMBOUS S-BSP+

HILTI



PERCEUSE HILTI UD30 _PERCEUSE HILTI SFH 22-A _PERCEUSE SPIT IDI 246 _VISSEUSE HILTI SF 14-A _VISSEUSE HILTI SFC 14-A _VISSEUSE HILTI SFC 22-A _VISSEUSE SPIT HDI 286

RÉF. ART.	DESCRIPTION	REFERENCE FABRICANT
EL017071	25/1" (35) ACIER	2039199
EL000237	PH 25/1 T (60) HILTI	2039196
EL000236	T 25/1 T (60) HILTI	2039198
EL000238	UNI 25/1 T (60) HILTI	2039195

DOUILLE IMPACT S-NSD 1/4

HILTI



VISSEUSE HILTI SF 14-A _VISSEUSE HILTI SFC 14-A _VISSEUSE HILTI SF 22-A _VISSEUSE SPIT HDI 286

Douille à tige hexagonale (gamme HKH) 1/4"

RÉF. ART.	DESCRIPTION	LONGUEUR	REFERENCE FABRI-CANT
CO003284	DOUILLE IMPACT S-NSD 10 1/4	L 104 MM	376701
CO003285	DOUILLE IMPACT S-NSD 13 1/4	L 104 MM	376702

DOUILLE S-NS

HILTI



AUTRE VISSEUSE HILTI

6 pans non magnétique - Douille magnétique

RÉF. ART.	DESCRIPTION	REFERENCE FABRICANT
EL003721	8 C 50/2 (remplace H308901)	2039244

EMBOUT DE VISSAGE S-B

HILTI



PERCEUSE HILTI UD30 _PERCEUSE HILTI SFH 22-A _PERCEUSE SPIT IDI 246 _VISSEUSE HILTI SF 14-A _VISSEUSE HILTI SFC 14-A _VISSEUSE HILTI SFC 22-A _VISSEUSE SPIT HDI 286

RÉF. ART.	DESCRIPTION	REFERENCE FABRICANT
EL002105	PH2 25/1 IMP BT DE 10	2039116
EL002104	PH2 50/2 IMP (5) BOITE DE 5	2039126
EL002107	PH3 50/2 IMP (5) BOITE DE 5	2039127
EL002108	PZ2 25/1 IMP BT DE 10	2039118
EL002109	PZ2 50/2 IMP (5) BOITE DE 5	2039128
EL002111	PZ3 50/2 IMP (5) BOITE DE 5	2039129
EL002112	TX20 25/1 IMP BT DE 10	2039120
EL002113	TX20 50/2 IMP (5) BOITE DE 5	2039130
EL002114	TX25 25/1 IMP BT DE 10	2039121
EL002115	TX25 50/2 IMP (5) BOITE DE 5	2039131
EL002116	TX30 25/1 IMP BT DE 10	2039122
EL002117	TX30 50/2 IMP (5) BOITE DE 5	2039132
EL002118	TX40 25/1 IMP BT DE 10	2039123
EL002119	TX40 50/2 IMP (5) BOITE DE 5	2039133

photos non contractuelles

EMBOUT DE VISSAGE S-BSC

HILTI



PERCEUSE HILTI UD30 _PERCEUSE HILTI SFH 22-A _PERCEUSE SPIT IDI 246 _VISSEUSE HILTI SF 14-A _VISSEUSE HILTI SFC 14-A _VISSEUSE HILTI SFC 22-A _VISSEUSE SPIT HDI 286

RÉF. ART.	DESCRIPTION	REFERENCE FABRICANT
EL002127	+ UNI 25/1 IMP BT DE 10	2039183
EL002126		2039186
EL002123	UNI 50/2 IMP BT DE 6	2039178

EMBOUT DE VISSAGE

HILTI



PERCEUSE HILTI UD30 _PERCEUSE HILTI SFH 22-A _PERCEUSE SPIT IDI 246 _VISSEUSE HILTI SF 14-A _VISSEUSE HILTI SFC 14-A _VISSEUSE HILTI SFC 22-A _VISSEUSE SPIT HDI 286

RÉF. ART.	DESCRIPTION	REFERENCE FABRICANT
EL002124	S-BSC+ UNI 25/1 IMP BT DE 10	2039190

EMBOUT

HILTI



PERCEUSE HILTI UD30 _PERCEUSE HILTI SFH 22-A _PERCEUSE SPIT IDI 246 _VISSEUSE HILTI SF 14-A _VISSEUSE HILTI SFC 14-A _VISSEUSE HILTI SFC 22-A _VISSEUSE SPIT HDI 286

RÉF. ART.	DESCRIPTION	REFERENCE FABRICANT
EL008974	S-SY PH2 116/4 1/2 BOITE DE 5	2039151

EMBOUT TOURNEVIS S-B

HILTI

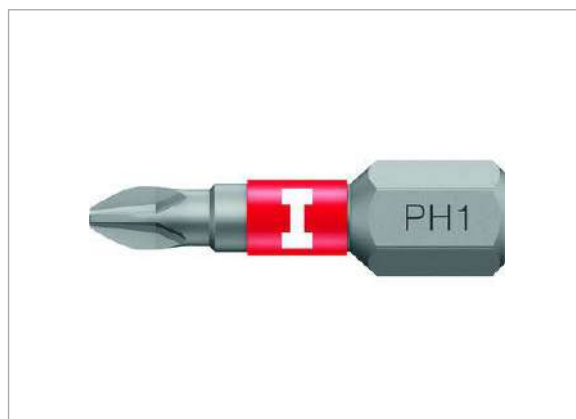

PERCEUSE HILTI UD30 _PERCEUSE HILTI SFH 22-A _PERCEUSE SPIT IDI 246 _VISSEUSE HILTI SF 14-A _VISSEUSE HILTI SFC 14-A _VISSEUSE HILTI SFC 22-A _VISSEUSE SPIT HDI 286

Empreinte Phillips

RÉF. ART.	DESCRIPTION	REFERENCE FABRICANT
EL002130	PH1 25/1 T (25) BOITE DE 25	2038976
EL002131	PH2 25/1 T (10) BOITE DE 10	2038979
EL002132	PH3 25/1 T (10) BOITE DE 10	2039039
EL002133	PZ1 25/1 T (25) BOITE DE 25	2039045
EL002134	PZ2 25/1 T (10) BOITE DE 10	2039047
EL002135	PZ3 25/1 T (10) BOITE DE 10	2039051
EL002136	TX10 25/1 T (10) BOITE DE 10	2039055
EL008652	TX15 25/1 T (10) BOITE DE 10	2039056
EL002137	TX20 25/1 T (10) BOITE DE 10	2039057
EL002138	TX25 25/1 T (10) BOITE DE 10	2039059
EL002139	TX30 25/1 T (10) BOITE DE 10	2039062
EL002140	TX30 25/1 T-HF BOITE DE 10	2039139
EL002141	TX40 25/1 T-HF BOITE DE 10	2039140
EL002142	TX50 35/1 1/4 S BTE DE 5	2039066

photos non contractuelles

EMBOUT TOURNEVIS S-SY

HILTI

PERCEUSE HILTI UD30 _PERCEUSE HILTI SFH 22-A _PERCEUSE SPIT IDI 246 _VISSEUSE HILTI SF 14-A _VISSEUSE HILTI SFC 14-A _VISSEUSE HILTI SFC 22-A _VISSEUSE SPIT HDI 286
Embouts de vissage pour système

RÉF. ART.	DESCRIPTION	REFERENCE FABRICANT
EL009593	TX45 35 HUS BOITE DE 10	2094674
EL009697	TX50 35 HUS BTE DE 5	2094675

EMBOUT-TOURNEVIS S-B PH2

HILTI

PERCEUSE HILTI UD30 _PERCEUSE HILTI SFH 22-A _PERCEUSE SPIT IDI 246 _VISSEUSE HILTI SF 14-A _VISSEUSE HILTI SFC 14-A _VISSEUSE HILTI SFC 22-A _VISSEUSE SPIT HDI 286

RÉF. ART.	DESCRIPTION	REFERENCE FABRICANT
EL012834	25/1" IF " LOT DE 10	2039035
EL012833	25/1" T-D " LOT DE 10	2039038

EMBOUT-TOURNEVIS S-B HEX5 2

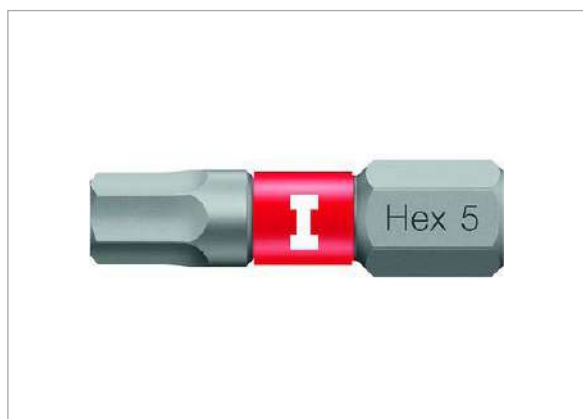
HILTI

PERCEUSE HILTI UD30 _PERCEUSE HILTI SFH 22-A _PERCEUSE SPIT IDI 246 _VISSEUSE HILTI SF 14-A _VISSEUSE HILTI SFC 14-A _VISSEUSE HILTI SFC 22-A _VISSEUSE SPIT HDI 286

RÉF. ART.	DESCRIPTION	REFERENCE FABRICANT
EL012831	5/1" HP " LOT DE 10	2039069

EMBOUT-TOURNEVIS S-B PZ1

HILTI

PERCEUSE HILTI UD30 _PERCEUSE HILTI SFH 22-A _PERCEUSE SPIT IDI 246 _VISSEUSE HILTI SF 14-A _VISSEUSE HILTI SFC 14-A _VISSEUSE HILTI SFC 22-A _VISSEUSE SPIT HDI 286

RÉF. ART.	DESCRIPTION	REFERENCE FABRICANT
EL012837	50/2" T (5)" LOT DE 5	2039085

EMBOUT-TOURNEVIS S-B SQ2

HILTI



PERCEUSE HILTI UD30 _PERCEUSE HILTI SFH 22-A _PERCEUSE SPIT IDI 246 _VISSEUSE HILTI SF 14-A _VISSEUSE HILTI SFC 14-A _VISSEUSE HILTI SFC 22-A _VISSEUSE SPIT HDI 286

RÉF. ART.	DESCRIPTION	REFERENCE FABRICANT
EL012842	25/1" S (10)" LOT DE 10	2039074

EMBOUT-TOURNEVIS S-SY PH2 81/3

HILTI



PERCEUSE HILTI UD30 _PERCEUSE HILTI SFH 22-A _PERCEUSE SPIT IDI 246 _VISSEUSE HILTI SF 14-A _VISSEUSE HILTI SFC 14-A _VISSEUSE HILTI SFC 22-A _VISSEUSE SPIT HDI 286

RÉF. ART.	DESCRIPTION	REFERENCE FABRICANT
EL012849	1/4" " LOT DE 10	2039291
EL012850	1/4" LOT DE 5	2039290

EMBOUT-TOURNEVIS S-SY PH2

HILTI



RÉF. ART.	DESCRIPTION	REFERENCE FABRICANT
EL018793	102/4" - LOT DE 10"	2131009
EL012847	116/4 1/2" LOT DE 10	2039152
EL012848	166/6 1/2" LOT DE 10	2039154

PORTE EMBOUT S-BH IMP

HILTI

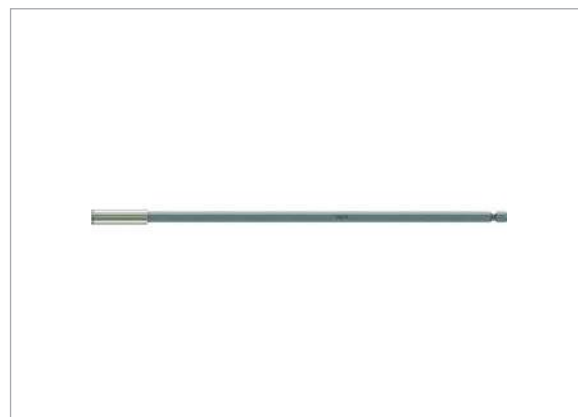

AUTRE VISSEUSE HILTI
Porte-embout magnétique

RÉF. ART.	DESCRIPTION	LONGUEUR	REFERENCE FABRICANT
EL010384	300/12 " RM	L 300 MM	2039212
EL010383	450/18 " RM	L 450 MM	2039213
EL010382	75/3 RM"	L 75 MM	2039216

photos non contractuelles

PORTE EMBOUT S-SYBH

HILTI



AUTRE VISSEUSE HILTI
Porte-embout magnétique

RÉF. ART.	DESCRIPTION	REFERENCE FABRICANT
EL010385	SF 4000/-A	2045969

PORTE EMBOUT S-BH M

HILTI

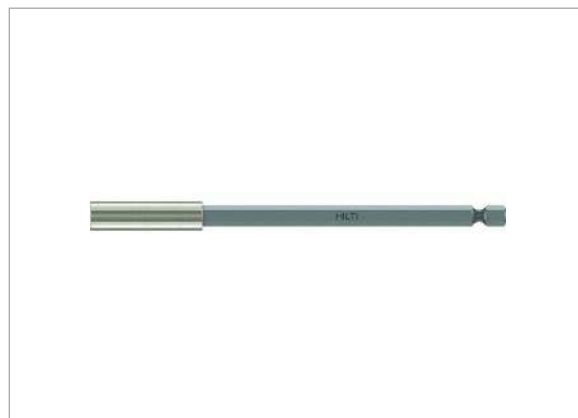

AUTRE VISSEUSE HILTI
Porte-embout magnétique

RÉF. ART.	DESCRIPTION	LONGUEUR	REFERENCE FABRICANT
EL010116	152/6	L 152 MM	2039211

PORTE-EMBOUT S-BH M

HILTI



AUTRE VISSEUSE HILTI
Porte-embout magnétique

RÉF. ART.	DESCRIPTION	LONGUEUR	REFERENCE FABRICANT
EL003715	50/2 (remplace H250062)	L 50 MM	2039223
EL003714	50/2 (remplace H257257)	L 50 MM	2038758
EL003716	75/3 (remplace H257258)	L 75 MM	2038759

PORTE-EMBOUT S-BH QC

HILTI



AUTRE VISSEUSE HILTI
Porte-embout rapidement interchangeable

RÉF. ART.	DESCRIPTION	LONGUEUR	REFERENCE FABRICANT
EL003717	50/2 (remplace H258987)	L 50 MM	2039217
EL003718	75/3 SDS (remplace H306013)	L 75 MM	2039218

photos non contractuelles

PORTE-EMBOUT S-NS

HILTI



AUTRE VISSEUSE HILTI
6 pans non magnétique - Douille magnétique

RÉF. ART.	DESCRIPTION	REFERENCE FABRICANT
EL003719	10 C 50/2 (remplace H308902)	2039245
EL003720	13 C 90/3 1/2 (remplace H318364)	2039251

TOURNEVIS S-SD-S

HILTI



RÉF. ART.	DESCRIPTION	REFERENCE FABRICANT
EL020032	COMP (7) KIT	2039207
EL018184	VDE QC	2039209

BOITIER VISSAGE SPIT 6 EMBOUTS + PEM

SPIT

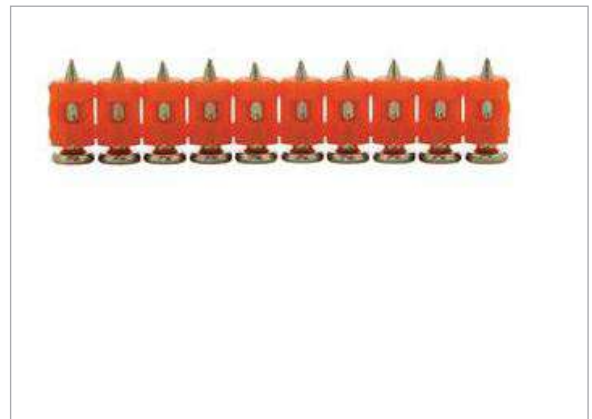

PERCEUSE SPIT IDI 246_PERCEUSE SFH 22-A_PERCEUSE HILTI UD30_VISSEUSE SPIT HDI 286_VISSEUSE HILTI SF 14-A_VISSEUSE HILTI SFC 14-A_VISSEUSE HILTI SFC 22-A UTILISABLE SUR TOUT TYPE DE VISSEUSE - 1

RÉF. ART.	REFERENCE FABRICANT
EL006138	10118

PORTE EMBOUT VIS. MAGNET. S2S

SPIT



PERFORATEUR HILTI TE 6-A36_PERFORATEUR HILTI TE 30-A36_PERFORATEUR HILTI TE 2-A22_PERFORATEUR SPIT 321_PERFORATEUR SPIT 323_PERFORATEUR HILTI TE 2-M_PERFORATEUR BURINEUR DHR243RMJV

RÉF. ART.	REFERENCE FABRICANT
EL007081	112070

photos non contractuelles

KIT COMMUNICATION TOPSITE A COMPLETER -

- KIT COMPLET TOPSITE COMPRENANT :

- 1 MÂT DE 6 M AVEC POTENCE ET SON DRAPEAU HAUTEUR 3,40 M X 1,20 M
- 1 BEACHFLAG POUR L'EXTÉRIEUR COMPRENANT UNE VOILE HAUTEUR DE 2,30 M X 0,70 M ET UN MÂT HAUTEUR DE 2,80 M AVEC PIED CROISILLON D'UN POIDS DE 16 KG
- 1 KAKÉMONO (ROLLUP) POUR L'INTÉRIEUR HAUTEUR 2 M X 0,80 M
- 200 STICKERS FOND BLANC 7 X 5 CM LOGO TOPSITE ET BASELINE
- 10 AFFICHES FORMAT A3 + DOCUMENT « SATISFACTION CLIENT » EN 2 EXEMPLAIRES

A LA COMMANDE PRÉCISER :

- LE CHOIX DE LOGO

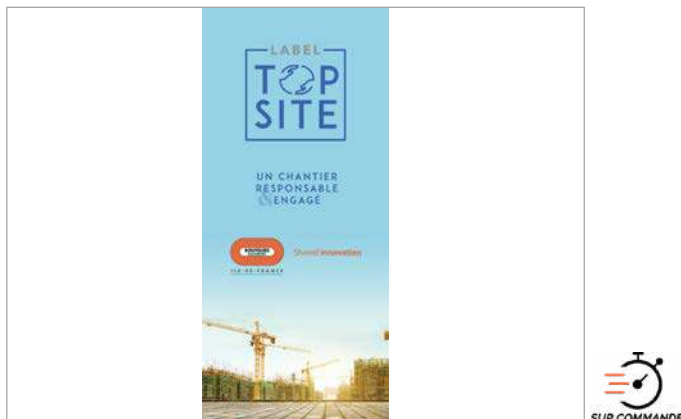

RÉF. ART.	DESCRIPTION
PR018426	KIT COMMUNICATION TOPSITE A COMPLETER

POUR TOUTE DEMANDE, contactez Catherine Desprez



RÉF. ART.	DESCRIPTION
PR00000	

KIT WIZOM RÉHABILITATION CHANTIER À COMPLÉTER

SUR COMMANDE - KIT COMPLET WIZOM CHANTIER COMPRENANT :

- 2 VOILES WINFLAG 230
- 2 MÂTS WINFLAG 230 EN POLYCARBONATE
- 2 PIEDS CROISILLON 14 KG GRIS RAL 9006 POUR WINFLAG
- 2 BANDEROLES PVC FRONTLIT 510G/M² 90X300 CM
- 1 ROLLER BANNER 200X80CM
- 2 GILETS ORANGE AVEC POCHE ET MARQUAGE DOS T.L
- 1 JEU DE 4 AFFICHES PAPIER 120G 600X800 MM
- 6 STICKERS 29,7X16 CM
- 1 BANDEROLE PVC FRONTLIT 510G/M² 190X300 CM
- OU
- 1 BANDEROLE SMIILE PVC FRONTLIT 510G/M² 190X300 CM
- 1 TRANSPORT FRANCE (MESS)



RÉF. ART.	DESCRIPTION
PR018693	(SUR COMMANDE)

KIT WIZOM RÉHABILITATION COMMERÇANT À COMPLÉTER

KIT WIZOM COMMERÇANT COMPRENANT :

1 ROLLER BANNER 200X80CM

1 JEU DE 4 AFFICHES PAPIER 120G 600X800 MM

1 TRANSPORT FRANCE (MESSAGERIE)

PERSONNALISATION À PRÉCISER : LOGO ENTITÉ + LOGO MAÎTRE D'OUVRAGE
+ NOM DE LA RÉSIDENCE

CONTACT DISTRIMO : CATHERINE DESPREZ 02.78.62.58.78 C.DESPREZ@
BOUYGUES-CONSTRUCTION.COM OU NADINE AUBRY 02.78.62.53.92
N.AUBRY@BOUYGUES-CONSTRUCTION.COM

DÉLAI DE LIVRAISON : 15 JOURS OUVRÉS APRÈS ACCORD DES BAT



RÉF. ART.

PR018695

RÉASSORT KIT WIZOM RÉHABILITATION CHANTIER

ÉLÉMENT DU KIT EN SUPPLÉMENT SOUS RÉSERVE DE L'ACHAT D'UN KIT
COMPLET

CONTACT DISTRIMO : CATHERINE DESPREZ 02.78.62.58.78 C.DESPREZ@
BOUYGUES-CONSTRUCTION.COM OU NADINE AUBRY 02.78.62.53.92
N.AUBRY@BOUYGUES-CONSTRUCTION.COM

DÉLAI DE LIVRAISON : 15 JOURS OUVRÉS APRÈS ACCORD DES BAT



RÉF. ART.

PR018704

WIZOM REHA SMILE LOT 200 STICKS P



RÉF. ART.	DESCRIPTION
SI020426	TE R&V190X120MM BY BAT CSO
SI020423	TE R&V190X120MM BY BAT GO
SI020427	TE R&V190X120MM BY BAT HRE
SI020424	TE R&V190X120MM BY BAT NE
SI020425	TE R&V190X120MM BY BAT SE
SI020428	TE R&V190X120MM BZ

photos non contractuelles

BAC DE RÉTENTION

DELAHAYE ENVIRONNEMENT



RÉF. ART.	DESCRIPTION
EN000177	EN ACIER GALVANISÉ POUR 2 FÛTS
EN000173	EN POLYÉTHYLÈNE 100L
EN000175	EN POLYÉTHYLÈNE 25L
EN000176	EN POLYÉTHYLÈNE 30L
EN000174	EN POLYÉTHYLÈNE POUR 2 FÛTS

BAC DE RETENTION POUR CUVE

DELAHAYE ENVIRONNEMENT



RÉF. ART.	DESCRIPTION
EN000178	1000L OU 4 FUT POLYETHYLENE
EN000179	1000L OU 4 FUTS ACIER GALVANISE

BAC PLASTIQUE DE RAYONNAGE POUR PRODUITS POLLUANTS

BAC PLASTIQUE 34L - 600X400X170 - GRIS - POUR ETAGERE ARMOIRE PRODUITS POLLUANTS



RÉF. ART.	DESCRIPTION
EN000180	34L

BARRAGE ABSORBANT HYDROCARBURE

DELAHAYE ENVIRONNEMENT



RÉF. ART.	DESCRIPTION
EN005757	D.13CM L.3M

BOBINES D'ESSUYAGE POLYPROPYLÈNE

DELAHAYE ENVIRONNEMENT



RÉF. ART.	DESCRIPTION
EN001800	300 FEUILLES TOUS LIQUIDES

photos non contractuelles

CHIFFON D'ESSUYAGE NON-TISSÉ



RÉF. ART.	DESCRIPTION
EN007484	L.42CM L.38CM

FEUILLES ABSORBANTES

DELAHAYE ENVIRONNEMENT



RÉF. ART.	DESCRIPTION
EN005765	HYDROCARBURES L.50CM L.40CM
EN005764	TOUS LIQUIDES L.50CM L.40CM

DÉPOLLUTION - 100 FEUILLES ABSORBANTES

DELAHAYE ENVIRONNEMENT



DOUBLE EPAISSEUR

RÉF. ART.	DESCRIPTION
EN001798	L.52CM L.40CM

DÉPOLLUTION - GRANULE MINÉRAL HYDROCARBONE ABSORBANTE

DELAHAYE ENVIRONNEMENT



RÉF. ART.	DESCRIPTION
EN001802	, 20KG

GRANULÉS ABSORBANTS DE TERRE DE DIATOMÉE ROUGE

DELAHAYE ENVIRONNEMENT



RÉF. ART.	DESCRIPTION
EN004244	, SAC DE 20KG

photos non contractuelles

KIT DE DÉPOLLUTION HYDROCARBURE

DELAHAYE ENVIRONNEMENT



RÉF. ART.	DESCRIPTION
EN002503	ABSORPTION 20L IDF/CPI
EN002504	ABSORPTION 70L

ROULEAU ABSORBANT HYDROCARBURE PRÉDÉCOUPÉ

DELAHAYE ENVIRONNEMENT



RÉF. ART.	DESCRIPTION
EN007976	D.40CM L.40M
EN007977	D.80CM L.40M

KIT D'INTERVENTION HYDROCARBURES

DELAHAYE ENVIRONNEMENT



RÉF. ART.	DESCRIPTION
EN002511	EN COFFRE 50L
EN002512	EN SAC 50L

ROULEAU ABSORBANT TOUS LIQUIDES

DELAHAYE ENVIRONNEMENT



RÉF. ART.	DESCRIPTION
EN007974	PRÉDÉCOUPÉ D.40CM L.40M
EN007975	ROULEAU ABSORBANT À TOUS LIQUIDES PRÉDÉCOUPÉ D.80CM L.40M

KIT D'INTERVENTION TOUS LIQUIDES

DELAHAYE ENVIRONNEMENT



RÉF. ART.	DESCRIPTION
EN002505	KIT D'INTERVENTION TOUS LIQUIDES 10L

photos non contractuelles

SUPPORT EN POLYÉTHYLÈNE

DELAHAYE ENVIRONNEMENT



RÉF. ART.	DESCRIPTION
EN004135	POUR 1 FÛT COUCHÉ DE 220L
EN004136	POUR 2 FÛTS COUCHÉS DE 220L

TAPIS ABSORBANT

DELAHAYE ENVIRONNEMENT



RÉF. ART.	DESCRIPTION
EN008045	HYDROCARBURES ÉTANCHE L.40M L.80CM
EN008044	TOUS LIQUIDES ÉTANCHE L.40M L.80CM

photos non contractuelles

ASPIRATEUR CP15 CHANGEpac 15L

LAPRO



we  life

SANS CARTOUCHE

RÉF. ART.	DESCRIPTION
EN100562	1200W KIT SPECIAL AMIANTE

CARTOUCHE ETANCHE ASPIRATEUR CP15

LAPRO



we  life

pour aspirateur CP15 EN100562

RÉF. ART.	DESCRIPTION
EN100563	CHANGEpac INCLUANT THE H14

EASY GEL PROTECT STANDARD POCHE250ML

SEBEMEX



we  life

AVEC COLLECTEUR POUR AMIANTE

RÉF. ART.	DESCRIPTION
EN100659	PERCEGEDE 10 A 12MM

SIGNIFICATION DISTRIPLUS & WE LOVE LIFE



RÉF. ART.
PICTOS

SOLUTION RECYCLAGE CASQUES ELECTROPORTATIFS



RÉF. ART.
RECYCLAGE

SUR COMMANDE = soumis à des délais supérieurs à ceux habituels

SUR COMMANDE = SOUMIS À DES DÉLAIS SUPÉRIEURS À CEUX HABITUELS



RÉF. ART.
SUR COMMANDE

PERCE-TOUT BOHRFIXX

SEBEMEX



POUR FORET JUSQU'A 12MM

RÉF. ART.	DESCRIPTION
EN100658	FLEXIBLE 32 A 42 MM / BF 12W

PULVÉRISATEUR IMPREGNANT ET FIXATEUR

SEBEMEX



PRODUIT D'IMPREGNATION ET FIXATION. L'imprégnant amiante 32-60 est une composition à base de polymères en dispersion aqueuse. Couleur: bleu/ incolore - Masse volumique: 1,01 (kg/l). Classement au feu: M1.

RÉF. ART.	DESCRIPTION
EN007804	250ML

photos non contractuelles

RUBAN ADHESIF ATTENTION" CONTIENT AMIANTE

SEBEMEX



we
life

RÉF. ART.	DESCRIPTION
EN100657	100MLx50MM"

SAC DÉCHET AIMANTE 80μ

SEBEMEX



we
life

SACS AMIANTE - EXTRAMIANTE. Sac en polyéthylène moyenne densité avec marquage AMIANTE. CARTON DE 100 sacs. 80μ 90CM x 110CM

RÉF. ART.	DESCRIPTION
EN007813	L.110CM L.90CM

BROSSE À ONGLES SIMPLE FACE



RÉF. ART.

EN007448

EASY GEL PROTECT STANDARD

SEBEMEX



we
life

AVEC COLLECTEUR POUR AMIANTE

RÉF. ART.

DESCRIPTION

EN020798

POCHE100ML PERCAGE DE 4 A 8 MM

CORBEILLE METAL

MOBIKA



RÉF. ART.	DESCRIPTION
EN001459	CORBEILLE MÉTAL 15L

CORBEILLE PLASTIQUE



RÉF. ART.	DESCRIPTION
EN001457	À PAPIER 15L, NOIR

POUBELLE CAOUTCHOUC



RÉF. ART.	DESCRIPTION
EN003731	AVEC COUVERCLE 75L

POUBELLE PLASTIQUE



RÉF. ART.	DESCRIPTION
EN007730	80L

SAC POUBELLE



RÉF. ART.	DESCRIPTION
EN018506	100L
EN018507	160L
EN018504	30L
EN018505	50L NOIR

photos non contractuelles

BALAI BROSSÉ À VIS

PRÉVOIR MANCHE EN002761



RÉF. ART.

EN007061

BALAI COCO

PRÉVOIR MANCHE EN002760



RÉF. ART.

DESCRIPTION

LARGEUR

EN000191

L.29CM

129 CM

EN007461

L.60CM

160 CM

EN000192

À VIS L.29CM

129 CM

BALAI CANTONNIER

PRÉVOIR MANCHE EN002759



RÉF. ART.

DESCRIPTION

LARGEUR

EN000190

NYLON

EN000193

PIASSAVA L.32CM

132 CM

EN000189

L.60CM

160 CM

MANCHE À BALAI COCO

GOUVY



RÉF. ART.

DESCRIPTION

EN002761

AVEC VIS

EN002760

SANS VIS 1ER CHOIX

MANCHE À BALAI CANTONNIER

GOUVY

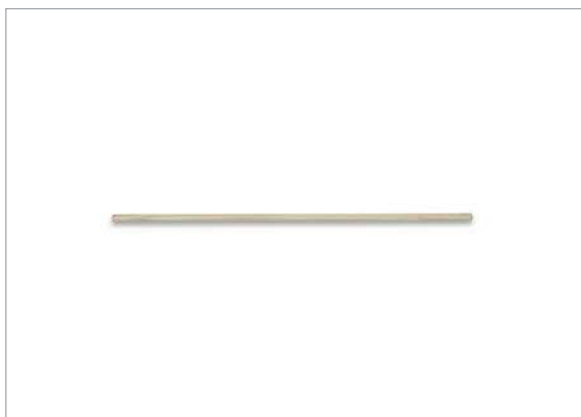

RÉF. ART.

DESCRIPTION

EN002759

1ER CHOIX

BALAI PAILLE DE RIZ

GOUVY



RÉF. ART.

DESCRIPTION

EN008529

5 FILS

photos non contractuelles

BALAI SOIE DROIT A VIS

PRÉVOIR MANCHE EN002761



RÉF. ART.	DESCRIPTION
EN007116	BALAI SOIE DROIT À VIS

RACLETTE MOUSSE



RÉF. ART.	DESCRIPTION	LARGEUR
EN007199	L.44CM (PREVOIR MANCHE)	144 CM
EN007200	L.55CM (PREVOIR MANCHE)	155 CM

BALAYETTE COCO



RÉF. ART.
EN007462

RACLETTE PLASTIQUE



RÉF. ART.	DESCRIPTION
EN003788	À LAME CAOUTCHOUC POUR VITRES L.30CM

PELLE À POUSSIÈRE MÉTALLIQUE



RÉF. ART.
EN007201

CHIFFONS



RÉF. ART.	DESCRIPTION
EN007973	BLANCS EN COTON
EN007451	DE COULEUR

photos non contractuelles

EPONGE DE MÉNAGE

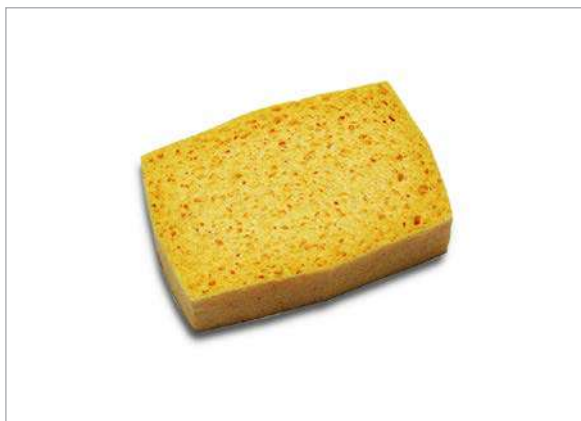

RÉF. ART.
EN007457

EPONGE VÉGÉTALE



RÉF. ART.	DESCRIPTION
EN007186	L.14CM L.9CM H.6CM
EN005629	KIT DE NETTOYAGE POUR ENGIN

EPONGE MAGIQUE



RÉF. ART.
EN002163

SCEAU PLASTIQUE



RÉF. ART.	DESCRIPTION
EN007449	DE MÉNAGE 10L

EPONGE SPONTEX

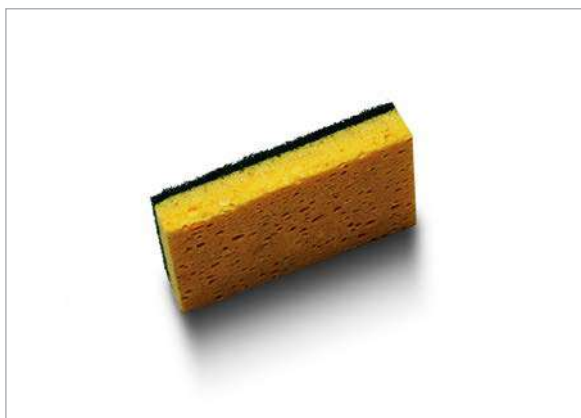

RÉF. ART.
EN007104

SERPILLÈRE



RÉF. ART.	DESCRIPTION
EN007041	DOUBLE

photos non contractuelles

TUYAU D'ARROSAGE JAUNE D.19MM

RÉF. ART.	DESCRIPTION	DIAMETRE
EN004561	L.25ML	D 19 MM
EN004562	L.50ML	D 19 MM

photos non contractuelles

ASPIRATEUR EAU ET POUSSIÈRE

LAURENT



RÉF. ART.	DESCRIPTION
EN000107	, CUVE 23L

ASPIRATEUR MÉNAGE SANS SAC

TORNADO



RÉF. ART.	DESCRIPTION
EN000108	, 700W

**ASPIRATEUR SUR BATTERIE + CHARGEUR
POUR KIT SAC GRUTIER**

RÉF. ART.
EN000109

photos non contractuelles

BALAYEUSE MÉCANIQUE KM 70/20C**KÄRCHER**

volume du conteneur : 20 L - dimensions : L795 * l400 * H935mm
- poids : 23kg

RÉF. ART.	DESCRIPTION
EN004848	L.795MM L.400MM 20L

LAVE-BOTTES 3 BROSSES

RÉF. ART.	DESCRIPTION
EN002700	(VIDANGE QUOTIDIENNE OBLIGATOIRE)

NETTOYEUR HAUTE PRESSION EAU FROIDE

KÄRCHER



220 VOLTS

RÉF. ART.	DESCRIPTION
EN007810	150 BARS

TRANSPORT EXPRESS

LE SERVICE TRANSPORT EXPRESS SUR MESURE VOUS ASSURE L'ENLÈVEMENT ET LA LIVRAISON DE COLIS, PLANS, PALETTES ET HORS-GABARIT DANS LES DÉLAIS LES PLUS COURTS.



RÉF. ART.	DESCRIPTION
Transport express	L.BONAVENTURE@bouygues-construction.com j.imboden@bouygues-construction.com

VERIFIEZ LA DISPONIBILITE DE NOS PRODUITS

DISTRIMO



En scannant le QR code, vérifiez le stock des produits à l'aide des références et de la barre de recherche

RÉF. ART.	DESCRIPTION
SITE WEB	http://distrimo.bouygues-construction.com/

photos non contractuelles

AÉROSOL AIR SEC DÉPOUSSIÉRANT



RÉF. ART.	DESCRIPTION
EN004812	AIRTOP

BALAI COMPLET WC

GOUVY



RÉF. ART.	DESCRIPTION
EN007435	

CRÈME À RÉCURER



RÉF. ART.	DESCRIPTION
EN007059	1L

DÉBOUCHEUR WC



RÉF. ART.	DESCRIPTION
EN007779	1L

CUBE URINOIR



RÉF. ART.	DESCRIPTION
EN007438	

DÉGRAISSANT BIDON



RÉF. ART.	DESCRIPTION
EN005470	VIAFLUX 25L

photos non contractuelles

DÉGRAISSANT POUR SOL



RÉF. ART.	DESCRIPTION
EN007342	5L

LIQUIDE AMMONIAQUE



RÉF. ART.	DESCRIPTION
EN007202	BIDON 5L

DÉTARTRANT LIQUIDE



RÉF. ART.	DESCRIPTION
EN007046	5L

LIQUIDE DE RINÇAGE



RÉF. ART.	DESCRIPTION
EN006147	POUR LAVE-VAISSELLE

JAVEL NET BIDON



RÉF. ART.	DESCRIPTION
EN007208	DE 2 LITRES

LIQUIDE VAISSELLE



RÉF. ART.	DESCRIPTION
EN007441	750ML

photos non contractuelles

LIQUIDE VITRE



RÉF. ART.	DESCRIPTION
EN007095	BIDON 5L

OXIDRINE LESSIVE

POUR NETTOYAGE AVANT PEINTURE



RÉF. ART.	DESCRIPTION
EN007209	1,4KG

POUDRE À RÉCURER +WC



RÉF. ART.	DESCRIPTION
EN007065	1KG

RÉNOVATEUR DE SURFACE TAGOX



RÉF. ART.	DESCRIPTION
EN005449	EN FLAÇON 1L

SAVON VÉGÉTAL



RÉF. ART.	DESCRIPTION
EN005400	E 15-30L

SEL RÉGÉNÉRANT POUR LAVE-VAISSELLE



RÉF. ART.	DESCRIPTION
EN006259	

photos non contractuelles

TABLETTES ECOLABEL POUR LAVE-VAISSELLE



RÉF. ART.
EN006515

VEGEMAIL PRODUIT BIO



RÉF. ART.	DESCRIPTION
EN005468	VEGEMAIL EN BIDON 5L

VEGE FLASH PRODUIT BIO

DACD



Puissant nettoyeur -Dégraissant multi-usages - écologique concentré - Base, lavante 100 % d'origine végétal - Idéal pour le nettoyage sur divers support tel que : verre, bois, aluminium, sols, etc...

RÉF. ART.	DESCRIPTION
EN005465	VEGE FLASH PISTOLET DE 750 ML - PRODUIT BIO

photos non contractuelles

BRUMISATEUR D'EAU EN BOMBE POUR KIT SAC GRUTIER



RÉF. ART.
EN000341

DISTRIBUTEUR DE SAVON MURAL



RÉF. ART. DESCRIPTION
EN001878 SNM 522, 1L

DESODORISANT AÉROSOL



RÉF. ART. DESCRIPTION
EN007439 EN PARFUM DE CITRON

ESSUIE TOUT OUATE

ESSUIE TOUT OUATE BLANCHE 22X35 CM EN ROULEAU (VENDUS PAR LOTS DE 2 BOBINES)



RÉF. ART. DESCRIPTION
EN018502 BLANCHE D.22CM L.35CM
EN018503 ORANGE D.22CM L.35CM

DÉVIDOIR



RÉF. ART. DESCRIPTION
EN007060 POUR ROULEAU OUATE

DÉVIDOIR



RÉF. ART. DESCRIPTION
EN007513 MURAL POUR ROULEAU OUATE

photos non contractuelles

LINGETTE NETTOYANTE



RÉF. ART.	DESCRIPTION
EN007450	
EN007770	EN SEAU
EN008464	POUR LUNETTES

SAVON LIQUIDE



RÉF. ART.	DESCRIPTION
EN007440	DE BUREAU BIDON 5L (PREVOIR POMPE EN007118)
EN007044	EN BIDON 5L (PREVOIR POMPE EN007436)

PAPIER DE TOILETTE PAQUET



RÉF. ART.	DESCRIPTION
EN018234	DE 6 ROULEAUX
EN007437	DE 6 ROULEAUX TAILLE MAXI

SAVON LOTION MOUSSANTE MÉDICALE



RÉF. ART.	DESCRIPTION
EN007502	BIDON (PREV. POMPE EN007118)

POMPE PLASTIQUE DOSEUSE POUR BIDON SAVON



RÉF. ART.	DESCRIPTION
EN007118	DE 5L

SAVON MICROBILLES EN BIDON



RÉF. ART.	DESCRIPTION
EN005399	4L AVEC POMPE INTÉGRÉE

photos non contractuelles

CASQUE BRENNUS avec jugulaire

AUBOUEIX



Avec aération + jugulaire coton

RÉF. ART.	DESCRIPTION	COULEUR
EP105892ORBGO	CASQUE BRENNUS avec jugulaire LOGO By Bat GO - Orange	ORANGE
EP105892ORBAT	CASQUE BRENNUS avec jugulaire LOGO By Bat IdF - Orange	ORANGE
EP105892ORBBI	CASQUE BRENNUS avec jugulaire LOGO By Bat Inter - Orange	ORANGE
EP105892ORBNE	CASQUE BRENNUS avec jugulaire LOGO By Bat NE - Orange	ORANGE
EP105892ORBSE	CASQUE BRENNUS avec jugulaire LOGO By Bat SE - Orange	ORANGE
EP105892BCBES	CASQUE BRENNUS avec jugulaire LOGO By E&S - Blanc	BLANC
EP105892BCNON	CASQUE BRENNUS avec jugulaire Sans Sigle - Blanc	BLANC
EP105892BLNON	CASQUE BRENNUS avec jugulaire Sans Sigle - Bleu	BLEU
EP105892JANON	CASQUE BRENNUS avec jugulaire Sans Sigle - Jaune	JAUNE
EP105892ORNON	CASQUE BRENNUS avec jugulaire Sans Sigle - Orange	ORANGE
EP105892VENON	CASQUE BRENNUS avec jugulaire Sans Sigle - Vert	VERT
EP008165BCBES	CASQUE BRENNUS BLANC BYES COIFFE CREM. SS AERATION	BLANC
EP105893BCBES	CASQUE BRENNUS SANS AERATION jugulaire LOGO By E&S - Blanc	BLANC

CASQUE DE MONTEUR

AUBOUEIX



RÉF. ART.	DESCRIPTION	COULEUR
EP004971OR0002	ORANGE	ORANGE

CASQUE E-MAN-BBL POUR ELECTRICIEN

INFIEL SAFETY



CASQUE E-MAN

Protection arc électrique < 1000V - Poids : 0,525kg - Durée d'utilisation : 5 ans

RÉF. ART.	DESCRIPTION	COULEUR
EP004972	BLANC CRASHBOX BLEU	BLANC

CASQUE IDRA 2 ELECTRICIEN

AUBOUEIX



calotte extérieure et intérieur ABS moulée sous pression - harnais / coiffe textile 4 points d'encrage - dimension écran 330 x 220 mm - résiste au très basses température : -30°C - isolement électrique sur modèle sans aération : 440V

RÉF. ART.	DESCRIPTION	COULEUR
EP008178ESBC	BLANC LOGO BYES	BLANC
EP008178SSBC	BLANC SANS SIGLE	BLANC
EP008178AXBC	BLANC LOGO AXIONE	

photos non contractuelles

CASQUE IRIS II PORTE-BADGE avec jugulaire

AUBOUEIX



Avec aération + lunettes + jugulaire 4 points noire boucle flash + Porte badge

RÉF. ART.	DESCRIPTION	COULEUR
EP105894BCAXI	CASQUE IRIS II PORTE-BADGE LOGO Axione Blanc	BLANC
EP105894VEBAL	CASQUE IRIS II PORTE-BADGE LOGO Balestrero Vert	VERT
EP105894BCBRZ	CASQUE IRIS II PORTE-BADGE LOGO Brezillon Blanc	BLANC
EP105894JABRZ	CASQUE IRIS II PORTE-BADGE LOGO Brezillon Jaune	JAUNE
EP105894ORBGO	CASQUE IRIS II PORTE-BADGE LOGO By Bat GO Orange	ORANGE
EP105894ORBAT	CASQUE IRIS II PORTE-BADGE LOGO By Bat Idf Orange	ORANGE
EP105894ORBNE	CASQUE IRIS II PORTE-BADGE LOGO By Bat NE Orange	ORANGE
EP105894ORBSE	CASQUE IRIS II PORTE-BADGE LOGO By Bat SE Orange	ORANGE
EP105894BCBES	CASQUE IRIS II PORTE-BADGE LOGO By E&S Blanc	BLANC
EP105894B5BES	CASQUE IRIS II PORTE-BADGE LOGO By E&S Bleu ral 5015	BLEU
EP105894ORBTP	CASQUE IRIS II PORTE-BADGE LOGO By TP Orange	ORANGE
EP105894BCNON	CASQUE IRIS II PORTE-BADGE Sans Sigle Blanc	BLANC
EP105894BLNON	CASQUE IRIS II PORTE-BADGE Sans Sigle Bleu	BLEU
EP105894JANON	CASQUE IRIS II PORTE-BADGE Sans Sigle Jaune	JAUNE
EP105894ORNON	CASQUE IRIS II PORTE-BADGE Sans Sigle Orange	ORANGE
EP105894RONON	CASQUE IRIS II PORTE-BADGE Sans Sigle Rouge	ORANGE
EP105895BCBES	CASQUE IRIS II PORTE-BADGE SANS AERATION LOGO By E&S Blanc	BLANC
EP105896ORMIR	CASQUE IRIS II PORTE-BADGE SANS LUNETTES. LOGO Miraglia Orange. SUR COMMANDE, Minimum 100 unités sinon frais de marquage, délai de 6 semaines	ORANGE
EP105894ORLOS	CASQUE IRIS II PORTE-BADGE + LUNETTES AVEC AERATION LOGO Losinger Orange	ORANGE
EP105894BCLOS	CASQUE IRIS II PORTE-BADGE + LUNETTES AVEC AERATION LOGO Losinger Blanc	BLANC

CASQUE IRIS II PORTE-ETIQUETTE avec jugulaire

AUBOUEIX



SANS SIGLE. Avec aération + lunettes + jugulaire 4 points noire boucle flash + Porte étiquette

RÉF. ART.	COULEUR
EP105897BCNON	BLANC
EP105897BLNON	BLEU
EP105897JANON	JAUNE
EP105897ORNON	ORANGE
EP105897VENON	VERT

CASQUE KARA SANS-LUNETTES avec jugulaire

AUBOUEIX



Avec jugulaire 4 points noire boucle flash + porte étiquette, sans lunettes

RÉF. ART.	DESCRIPTION	COULEUR
EP105900ORBNE	CASQUE KARA VISIERE LONGUE BB NE Orange	ORANGE
EP105900BCBES	CASQUE KARA VISIERE LONGUE By E&S Blanc	BLANC

photos non contractuelles

CASQUE KARA VISIERE COURTE avec jugulaire

AUBOEUX



Avec jugulaire 4 points noire boucle flash + porte étiquette + lunettes

RÉF. ART.	DESCRIPTION	COULEUR
EP105898BCAXI	CASQUE KARA VISIERE COURTE Axione Blanc	BLANC
EP105898ORBSN	CASQUE KARA VISIERE COURTE By Serv Nucl Orange	ORANGE

CASQUE KARA VISIERE LONGUE avec jugulaire

AUBOEUX



Avec jugulaire 4 points noire boucle flash + porte étiquette + lunettes

RÉF. ART.	DESCRIPTION	COULEUR
EP105899VEBAL	Balestrero Vert	VERT
EP105899ORBGO	By Bat GO Orange	ORANGE
EP105899ORBAT	By Bat Idf Orange	ORANGE
EP105899ORBBI	By Bat Inter Orange	ORANGE
EP105899ORBTP	By TP Orange	ORANGE
EP105899ORBUK	By UK Orange. Minimum 180 unités sinon frais de marquage. Délai 6 semaines	ORANGE
EP105899BCRIC	Richelmi Blanc	BLANC
EP105899BCNON		BLANC
EP105899BLNON		BLEU
EP105899JANON		JAUNE
EP105899ORNON	Sans Sigle	ORANGE
EP105899RONON		ROUGE
EP105899VENON		VERT

photos non contractuelles

CASQUE STRATO SANS AERATION avec jugulaire

PETZL



RÉF. ART.	DESCRIPTION
EP020392BCNON	CASQUE STRATO SANS AERATION JUGULAIRE 4 P. BLANC SS SIGLE

CASQUE VERTEX BEST

PETZL



Protection optimale pour les travaux en hauteur : - absorption des chocs réalisée par déformation de la calotte,- protection contre le risque électrique et la projection de métaux en fusion grâce à sa calotte fermée,- limitation du risque de perte du casque lors d'une chute grâce à la résistance élevée de la jugulaire (supérieure à 50 daN).Port très confortable : - coiffe textile six points épousant parfaitement la forme de la tête,

- système de réglage CenterFit pour ajuster le tour de tête en

RÉF. ART.	DESCRIPTION	COULEUR
EP010525SSJA	SANS SIGLE JAUNE	JAUNE

CASQUE VERTEX VENT

Protection excellente pour les travaux en hauteur : - absorption des chocs réalisée par déformation de la calotte, - limitation du risque de perte du casque lors d'une chute grâce à la résistance élevée de la jugulaire (supérieure à 50 daN). Port très confortable : - coiffe textile six points épousant parfaitement la forme de la tête, - système de réglage CenterFit pour ajuster le tour de tête en conservant le centrage du casque sur la tête, - trous de ventilation avec volets coulissants manipul

RÉF. ART.	DESCRIPTION	COULEUR
EP010522SSBC	SANS SIGLE BLANC	BLANC

CASQUE V-GARD 500 VENTILE avec jugulaire HORIZON

MSA FRANCE



Casque V-GARD 500 ventile+ jugul. logo HORIZON arriere blanc

RÉF. ART.	DESCRIPTION	COULEUR
EP017825BC	CASQUE V-GARD 500 VENTILE LOGO HORIZON ARRIERE BLC	Blanc
EP017825BL	CASQUE V-GARD 500 VENTILE LOGO HORIZON ARRIERE BLEU	Bleu
EP017825VE	CASQUE V-GARD 500 VENTILE LOGO HORIZON ARRIERE VERT	Vert

CASQUE V-GARD 500 NON VENTILE avec jugulaire HORIZON

MSA FRANCE



Casque V-GARD 500 non ventile+ jugul. logo HORIZON arriere gris

RÉF. ART.	DESCRIPTION	COULEUR
EP017824GS	CASQUE V-GARD 500 NON VENTILE. LOGO HORIZON ARR. GRIS	Gris

photos non contractuelles

CASQUETTE ANTI-HEURT FIRST BASE3

SCOTT

we
life

RÉF. ART.	DESCRIPTION	COULEUR
EP010629GSNON	CASQUETTE ANTI HEURT FIRST BASE 3 GRIS SANS SIGLE	GRIS
EP010629BMNON	CASQUETTE ANTI-HEURT FIRST BASE 3 CLASSIC MARINE SANS SIGLE	BLEU
EP010629ORNON	CASQUETTE ANTI-HEURT FIRST BASE 3 CLASSIC ORANGE SANS SIGLE	ORANGE
EP008409BMNON	CASQUETTE ANTI-HEURT FIRST BASE 3 XTRA MARINE SANS SIGLE	BLEU
EP010629BMAXI	CASQUETTE ANTI-HEURT FIRST BASE 3 CLASSIC-V54MM BL/MAR AXIONE	BLEU
EP010629BMBES	CASQUETTE ANTI-HEURT FIRST BASE 3 CLASSIC-V54MM BL/MAR BYES	BLEU
EP010629GSBES	CASQUETTE ANTI-HEURT FIRST BASE 3 CLASSIC - V54MM GRIS BYES	GRIS

CASQUETTE ANTI-HEURT HEADGUARD

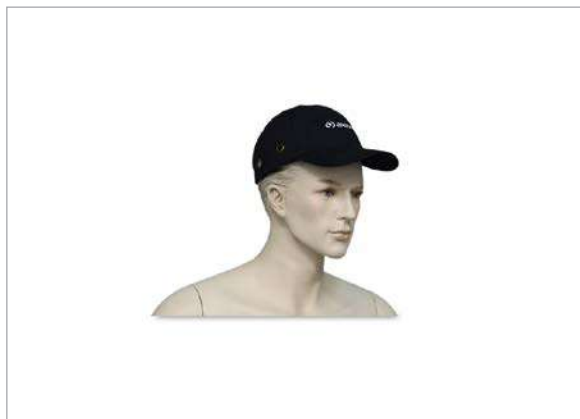
SINGER
safetywe
life

RÉF. ART.	DESCRIPTION	COULEUR
EP008192BMAXI	MARINE AXIONE	BLEU
EP008192ORNON	ORANGE SANS SIGLE	ORANGE

CASQUETTE SCARAP 3 LED USB AMOVIBLE RECHARGEABLE

SURFLEX

we
lifeFABRIQUE
EN FRANCE

MARINE BRODEE BYES

RÉF. ART.	DESCRIPTION
EP108011BMBES	- V30MM
EP108011NOBES	

CASQUETTE SCARAP 3 LED INTEGREE PILE FOURNIE

SURFLEX

we
lifeFABRIQUE
EN FRANCE

MARINE BRODEE BYES

RÉF. ART.	DESCRIPTION
EP108012BMBES	- V30MM
EP108012NOBES	

CASQUETTE SCARAP 3 SANS LED

SURFLEX

MARINE BRODEE BYES

RÉF. ART.	DESCRIPTION
EP111528BMBES	- V30MM
EP111528NOBES	

photos non contractuelles

LED USB RECHARGEABLE POUR CASQUETTE

SURFLEX



RÉF. ART.

EP108013

TRANSPORT EXPRESS

LE SERVICE TRANSPORT EXPRESS SUR MESURE VOUS ASSURE L'ENLÈVEMENT ET LA LIVRAISON DE COLIS, PLANS, PALETTES ET HORS-GABARIT DANS LES DÉLAIS LES PLUS COURTS.



RÉF. ART.

DESCRIPTION

Transport express

L.BONAVENTURE@bouygues-construction.com

j.imboden@bouygues-construction.com

Une idée de nouveau produit ?



RÉF. ART.

DESCRIPTION

NOUVEAU PRODUIT mailto:t.bobin@bouygues-construction.com

VERIFIEZ LA DISPONIBILITE DE NOS PRODUITS

DISTRIMO



En scannant le QR code, vérifiez le stock des produits à l'aide des références et de la barre de recherche

RÉF. ART.

DESCRIPTION

SITE WEB

<http://distrimo.bouygues-construction.com/>

photos non contractuelles

ADAPTATEUR POUR ANTI BRUIT + ECRAN SUR CASQUE IRIS2 / KARA

HOWARD LEIGHT



Adapteur pour fixation de la protection anti bruit et de l'écran sur casque type IRIS 2 et KARA

RÉF. ART.
EP000043

ADAPTATEUR POUR CASQUE IRIS / KARA POUR COQUILLE ET ECRAN

AUBOUEIX



RÉF. ART.	DESCRIPTION
EP020391	-

BANDE ADHÉSIVE POUR CASQUE

BANDE ADHESIVE BLEU 3M 10MX3CM POUR CASQUE REF 131150



RÉF. ART.	DESCRIPTION	COULEUR
SI009587	BANDE ADHÉSIVE BLEU POUR CASQUE	BLEU
EP000201	BANDE ADHÉSIVE GRISE POUR CASQUE - 10MX3CM (EN ROULEAU)	GRISE

KIT 6 STICKERS NID D'ABEILLE RETROREFLECHISSANT

AUBOUEIX

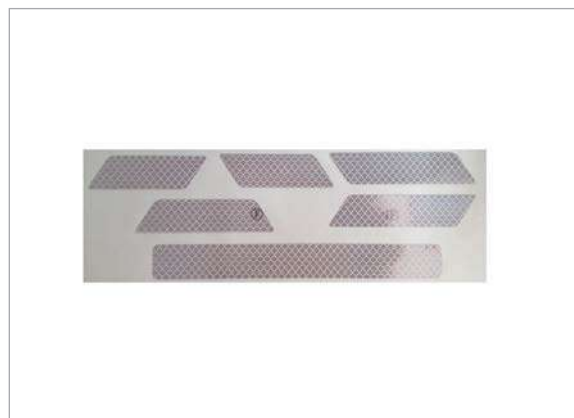

Kit 6 stickers nid d'abeille retroreflechissant pour casque gris

RÉF. ART.	DESCRIPTION
EP017943GS	KIT 6 STICKERS NID D'ABEILLE RETROREFLECHISS. P/CASQUE GRIS
EP017943VE	KIT 6 STICKERS NID D'ABEILLE RETROREFLECHISS. P/CASQUE VERT

COIFFE DE PROPLETE

COVERGUARD



COIFFE DE PROPLETE

RÉF. ART.

EP005695

COIFFE KARA / IRIS II AVEC CREMAILLERE (PETITE)

AUBOUEIX



KARA_IRIS II

RÉF. ART.

EP001211

COIFFE POLYETYLENE POUR CASQUE BRENNUS

AUBOUEIX



BRENNUS

RÉF. ART.

EP001212

COIFFE TEXTILE CREMAILLERE

AUBOUEIX

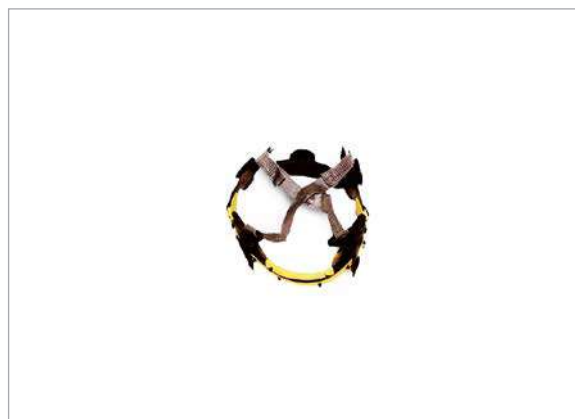

IRIS II

RÉF. ART.

DESCRIPTION

EP001213

IRIS II

EP001214

KARA

photos non contractuelles

CROCHET ADAPTATEUR LAMPE FRONTALE POUR CASQUE

AUBOUEIX

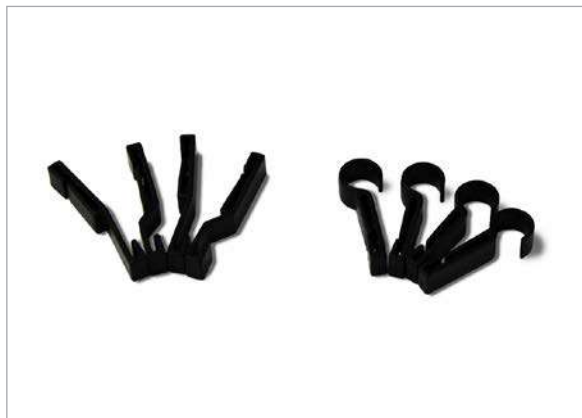

BRENNUS_KARA_IRIS II

RÉF. ART.	DESCRIPTION
EP001769	- JEU DE 2

ECRAN BULLE POUR CASQUE IDRA

AUBOUEIX



IDRA
ECRAN BULLE pour casque Idra Poids : 100 grammes Durée : 48 mois

RÉF. ART.
EP002006

ECRAN + CRASHBOX POUR CASQUE ELECTRICIEN

INFIEL SAFETY



RÉF. ART.	DESCRIPTION
EP002003	E-MAN-BBL

ECRAN BULLE POUR CASQUE IDRA 2

AUBOUEIX



IDRA II
Un écran intégré en polycarbonate d'une épaisseur de 2,2 mm, de classe optique 1. Traitement anti-buée intérieur et anti-rayures extérieur. essai d'épreuve diélectrique et essai de tenue diélectrique, protection contre l'électrisation sur installations ne dépassant pas 1000 v en courant alternatif ou 1500 v en courant continu, symbole double triangle, classe 0.

RÉF. ART.
EP002007

photos non contractuelles

ECRAN GRILLAGE POUR CASQUE IRIS II

HONEYWELL

we
life

IRIS II

RÉF. ART.

EP002009

ECRAN POLYCARBONATE POUR CASQUE

HONEYWELL

we
life

RÉF. ART.

EP002011

DESCRIPTION

CLEARWAYS HT RESIST- IMPACTS VIOLENTS

ETIQUETTE NOMINATIVE GRAVEE A COLLER

ETIQUETTE AUTOCOLLANTE



SUR COMMANDE

RÉF. ART.

EP002199

GARNITURE MOUSSE POUR COIFFE BRENNUS/IRIS/KARA NOUV. MODÈLE

AUBOUEIX



BRENNUS_KARA_IRIS II

RÉF. ART.

EP002339

GARNITURE PEAU POUR COIFFE BRENNUS/IRIS/KARA

AUBOUEIX

BRENNUS_KARA_IRIS II
(32 cm) POUR COIFFE

RÉF. ART.

EP002340

DESCRIPTION

GARNITURE PEAU POUR COIFFE BRENNUS/IRIS/KARA

photos non contractuelles

MOUSSE CONFORT VERTEX ET STRATO ABSORBANT LA TRANSPIRATION

LAVABLE EN MACHINE



RÉF. ART.	DESCRIPTION
EP100553	-

JUGULAIRE COTON

AUBOUEIX



BRENNUS

RÉF. ART.	DESCRIPTION
EP002495	POUR CASQUE

JUGULAIRE 4 POINTS

AUBOUEIX



KARA_IRIS II

RÉF. ART.	DESCRIPTION
EP020241	AVEC MENTONNIÈRE VELCRO
EP002497	BOUCLE FLASH POUR CASQUE

JUGULAIRE CUIR

AUBOUEIX



BRENNUS

RÉF. ART.	DESCRIPTION
EP002496	POUR CASQUE

photos non contractuelles

JUGULAIRE V-GARD

MSA FRANCE



V-GARD

RÉF. ART.	DESCRIPTION
EP020383	4 POINTS TEXTILE
EP017982	3 POINTS TEXTILE

PORTE BADGE VELCRO

AUBOUEIX



RÉF. ART.	DESCRIPTION
EP104707	ADAPTABLE SUR KARA - BRENNUS - IDRA

VISIÈRE POUR CASQUE IRIS ET KARA**3M**we
life

VISIÈRE POLYCARBONATE INCOLORE 1MM AVEC ADAPTEURS POUR CASQUE IRIS ET KARA - Marque 3M

RÉF. ART.	DESCRIPTION
EP020375	VISIÈRE POLYCARBONATE INCO 1MM + ADAPT P/CASQUE ET EXTENSION

VISIÈRE pour casques VERTEX et STRATO**PETZL**we
life

Visière complète d'élagage avec système EASYCLIP pour casques VERTEX et STRATO

RÉF. ART.	DESCRIPTION
EP104705	VISIÈRE VIZEN D'ELAGAGE POUR VERTEX ET ALVEO TEINTE

photos non contractuelles

LUNETTES VIZIR POUR CASQUE ALVEO BEST - JUSQU'À EPUISEMENT



CASQUE ALVEO BEST
La visière VIZIR est traitée anti-rayure et antibuée

RÉF. ART.	COULEUR
EP002734	INCOLORE

VISIÈRE VIZIR POUR VERTEX ET STRATO



RÉF. ART.	DESCRIPTION
EP100548	INCOLORE
EP104703	TEINTE

LAMPE LED FRONTALE



RÉF. ART.	DESCRIPTION
EP002685	A INTENSITE REGLABLE
EP010526	PIXA 3
EP020797	SUR ACCU RECHARGEABLE

PASSE MONTAGNE MARINE

SINGER



RÉF. ART.
EP003413

photos non contractuelles

PROTECTION POLAIRE TETE ET COU NOIRE TAILLE UNIQUE AJUSTABLE PAR CORDON

COVERGUARD



PROTECTION POLAIRE TETE ET COU NOIRE TAILLE UNIQUE
AJUSTABLE PAR CORDON

RÉF. ART.	DESCRIPTION
EP010072	PROTECTION POLAIRE TETE ET COU NOIRE TU AJUSTABLE PAR CORDON

TOUR DE COU TRAITE NON FEU

TOUR DE COU MULTIFONCTIONS ANTISTATIQUE, RÉSISTANT AU FEU. SE PORTE AUSSI BIEN EN ÉCHARPE, QU'EN CAGOULE, MASQUE CACHE-NEZ OU BIEN BONNET/PROTECTION SOUS-CASQUE. IDÉAL POUR LES SECTEURS : ÉLECTRICITÉ, PÉTROCHIMIE, FONDERIE, INDUSTRIE DU GAZ, POMPIERS, FORCES DE SÉCURITÉ... 68% LAINE PEIGNÉE, 30% ARAMIDE, 2% ANTISTATIQUE. TRICOTÉ EN JERSEY TUBULAIRE. DIMENSIONS 60 X 27 CM. JAUGE 12



RÉF. ART.	DESCRIPTION
EP004503	- TAILLE UNIQUE

BONNET DE PROTECTION ANTI-FROID



RÉF. ART.	TAILLE
EP005552GSS	S
EP005552GSM	M
EP005552GSL	L

BONNET POLAIRE POUR CASQUE

CENTURION



BRENNUS_KARA_IRIS II

RÉF. ART.
EP008002

photos non contractuelles

CACHE NEZ POUR BONNET ET PROTECTION DU COU

CENTURION



BRENNUS_KARA_IRIS II

A commander obligatoirement avec le bonnet polaire EP008002 et protection du cou EP008001

RÉF. ART.

EP008000

PROTECTION DU COU HV ORANGE POUR BONNET POLAIRE

CENTURION



BRENNUS_KARA_IRIS II

A commander obligatoirement avec le bonnet polaire EP008002

RÉF. ART.

EP008001

BONNET RESPIRANT LINER PETZL



Bonnet respirant pour l'évacuation de la transpiration

RÉF. ART. DESCRIPTION

EP104704T1 TAILLE 1

EP104704T2 TAILLE 2

CAGOLE DE PROTECTION AU FROID TRAITE NON FEU

67% LAINE PEIGNÉE - 30% ARAMIDE - 3% ANTISTATIQUE - RÉSISTANCE À L'ARC ÉLECTRIQUE - S'INTÈGRE DANS LA COIFFE DU CASQUE



RÉF. ART.

EP000443

CAGOULE EN CUIR POUR SOUDAGE ET OXYCOUPAGE



we
life

RÉF. ART.

EP006129

CAGOULE POLAIRE NOIRE BALACLAVA

COVERGUARD



RÉF. ART.

EP008698

CAGOULE SOUS CASQUE DEPERLANTE POLAIRE

AUBOUEIX



BRENNUS_KARA_IRIS II

S'intègre dans le casque

RÉF. ART.

EP005664

CAGOULE ÉTÉ SOMMET DE LA TÊTE ET DU COU RAFRAICHISSANT

MSA FRANCE



we
life

Sommet de tête : · Protège des conséquences des températures élevées · Systèmes d'attaches dédiés pour les coiffes des casques de la gamme V-Gard · Couleur : bleu royal

Saharienne : · Protège des conséquences des températures élevées et des effets du soleil sur la nuque · Systèmes d'attaches dédiés pour les coiffes des casques de la gamme V-Gard · Couleur : Jaune/Vert Haute visibilité (EN471)

RÉF. ART.

EP008459

photos non contractuelles

PROTEGE-NUQUE

CENTURION

we
life

BRENNUS_KARA_IRIS II

RÉF. ART.	DESCRIPTION
EP008003	PROTEGE NUQUE SUN CAPE ORANGE ANTI UV
EP104706	ORANGE POUR CASQUES VERTEX ET STRATO

photos non contractuelles

BOUCHONS D'OREILLES FIT'IN

API PROTECTION

we
life

un modèle ergonomique s'adaptant au conduit auditif, un réglage personnalisé anti-bruit, Silicone de haute qualité USP de classe 6, Texture agréable au porté, Composition anti-allergène, Entretien facilité

RÉF. ART.	DESCRIPTION
EP018692	ORANGE SNR 26 DB

STATION BOUCHONS D'OREILLES

MOLDEX

we
life

RÉF. ART.	DESCRIPTION
EP020767	BOUCHONS D'OREILLES MOLDEX STATION -SNR 35BB - BOITE DE 250

SUPPORT POUR STATION BOUCHONS D'OREILLES

MOLDEX

we
life

RÉF. ART.	DESCRIPTION
EP020766	-

BOUCHONS D'OREILLES

HOWARD LEIGHT

we
life

RÉF. ART.	DESCRIPTION
EP000263	MAX CORDELETTE BOITE DE 100 PAIRES

photos non contractuelles

BOUCHONS D'OREILLES AVEC CORDELETTE

MOLDEX



La poche d'air à l'extrémité et les collerettes de forme incurvée offrent un confort maximal. Le matériau souple utilisé donne une étanchéité agréable avec le conduit auditif. La tige en polypropylène permet une mise en place facile. Ils peuvent être lavés pour un usage répété. Une cordelette fait partie intégrante du bouchon. Atténuation du bruit FORTE : SNR = 30dB.

RÉF. ART.	DESCRIPTION
EP000264	BOUCHONS D'OREILLES MOLDEX AVEC CORDELETTE - SNR 30DB

CASQUE ANTI BRUIT SERRE TETE

HOWARD LEIGHT



JUSQU'À EPUISEMENT - Protection anti-bruit pour électricien (sans métal) - Serre tête : PUR-E, PVC, TEXTILE. Coquilles et Monture : ABS - Fourreau : PUR-E - Coussinets : PVC/PUR-E. Poids : 194 g. Atténuation du bruit : SNR = 25dB.

RÉF. ART.	DESCRIPTION
EP001453	C1 - SANS METAL - SNR 25DB
EP001454	C3 - SANS METAL - SNR 33DB
EP000496	CASQUE ANTI-BRUIT SERRE-TETE L1 - SNR 28DB

COLLERETTES POUR COQUILLE ANTI-BRUIT

HOWARD LEIGHT



COLLERETTES POUR COQUILLE ANTI-BRUIT Collettertes pour casques, absorbant la transpiration pour plus de confort d'hygiène.

RÉF. ART.
EP001217

COQUILLE ANTI-BRUIT C1H POUR CASQUE

HOWARD LEIGHT



Protection anti-bruit pour électricien (sans métal) - Dispositif antibruit adaptable sur casque de sécurité de type IRIS 2 et KARA. Atténuation du bruit : SNR = 26Db

RÉF. ART.	DESCRIPTION
EP001456	- SANS METAL - SNR 26DB
EP001455	COQUILLE ANTI-BRUIT C3H POUR CASQUE - SANS METAL - SNR 30DB

COQUILLE ANTI-BRUIT

3Mwe
life

RÉF. ART.	DESCRIPTION
EP007989	PELTOR H540B

COQUILLE ANTI-BRUIT POUR CASQUE
IRIS/KARA

HOWARD LEIGHT

we
life

IRIS II_KARA

COQUILLE ANTI-BRUIT POUR CASQUE IRIS II Dispositif anti-bruit adaptable sur casque de sécurité de type IRIS 2 Atténuation du bruit FORTE : SNR = 31Db

RÉF. ART.	DESCRIPTION
EP001452	+ADAPT-SNR 31DB

photos non contractuelles

LUNETTES RUSH+ MONTURE ORANGE

BOLLE SAFETY

we
life

RÉF. ART.	DESCRIPTION
EP017886IN	INCOLORE
EP017886TE	TEINTE

LUNETTES TRANSLUCIDES POUR CASQUE

AUBOUEIX



RÉF. ART.	DESCRIPTION	COULEUR
EP005545IN	IRIS II	INCOLORE
EP008109IN	KARA	INCOLORE

LUNETTES TEINTEES POUR CASQUE

AUBOUEIX



RÉF. ART.	DESCRIPTION	COULEUR
EP005545TE	IRIS II	TEINTEE
EP008109TE	KARA	TEINTEE

LUNETTE TRACKER II

BOLLE SAFETY

we
life

RÉF. ART.	DESCRIPTION	COULEUR
EP008107IN	- RENFORT EN MOUSSE - AVEC ETUI	INCOLORE
EP008107TE		TEINTEE

photos non contractuelles

LUNETTES DE PROTECTION CHALUMISTE RELEVABLE

BOLLE SAFETY



FABRICATION FRANCAISE Verre teinté 5

RÉF. ART.	DESCRIPTION	COULEUR
EP005761	BOLLE	TEINTEE

LUNETTES DE PROTECTION CONTOUR

BOLLE SAFETY



Verres incolore - Monture en nylon - Branches TipGrip - Protection latérale intégrée - Marquage 2C-1,2.1.F.T.

RÉF. ART.	DESCRIPTION	COULEUR
EP008108IN		INCOLORE
EP008108ST	BOLLE	SEMI-TEINTEE
EP008108TE		TEINTEE
EP008029PO	LUNETTES DE PROTECTION VERRS POLARISANTS SOLIPOL BOLLE	POLARISANT

photos non contractuelles

CORDON REGLABLE POUR LUNETTES

COVERGUARD



RÉF. ART.

EP005716

ETUI SEMI RIGIDE POUR LUNETTES AVEC PASSANT CEINTURE

BOLLE SAFETY



ETUI SEMI RIGIDE POUR LUNETTES AVEC PASSANT CEINTURE 170X65X85 (60GRS)

RÉF. ART.

COULEUR

EP010509

NOIR

ETUI TISSUS POUR LUNETTE

RÉF. ART.

EP005717

photos non contractuelles

LUNETTE MASQUE BLAST

BOLLE SAFETY

we
life

RÉF. ART.	COULEUR
EP005755	INCOLORE

PARE VISAGE ADAPTABLE SUR MASQUE BLAST SUR LUNETTES

BOLLE SAFETY

we
life

RÉF. ART.	COULEUR
EP005756	INCOLORE

LUNETTES MASQUE ULTRASONIC UVEX

CONTOUR GRIS

we
life

Marquage 2-1,2.W.1.B.9.K.N - Poids : 80g

RÉF. ART.	COULEUR
EP002730	INCOLORE

ETUI POUR LUNETTE MASQUE ULTRASONIC UVEX

uvex

LUNETTE UVEX ULTRASONIC
Etui avec double poche - Se porte à la ceinture

RÉF. ART.
EP002221

photos non contractuelles

LUNETTES OU SURLUNETTES DE PROTECTION POUR GRANDE MONTURE

uvex



we
life

RÉF. ART.	COULEUR
EP100208	INCOLORE

LUNETTES OU SURLUNETTES DE PROTECTION POUR PETITE MONTURE

SINGER
safety



we
life

RÉF. ART.	COULEUR
EP007910	INCOLORE

CASQUE DE SOUDEUR MASQUE SUPER ROBUR

ROBUR



we
life

Polyester renforcé en fibre de verre - Résistance à la chaleur 400°C - Poids 435g

RÉF. ART.	DESCRIPTION
EP000498	105*50

ECRAN BLANC 105 X 50 POUR CASQUE DE SOUDEUR

SAF-FRO

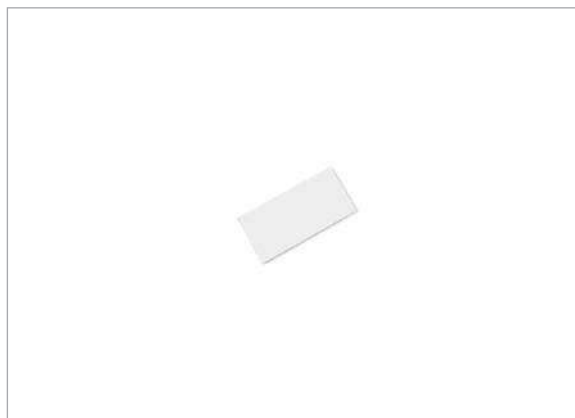

RÉF. ART.
EP002005

ECRAN NOIR 105 X 50 - T11 - POUR CASQUE DE SOUDEUR

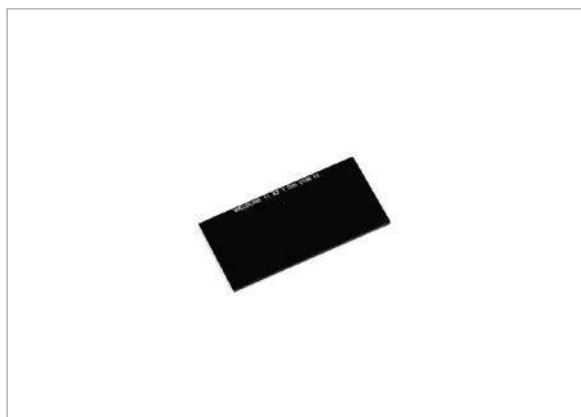

RÉF. ART.

EP002010

MASQUE DE SOUDEUR + CASQUE DE PROTECTION

SIMA



we
life

MASQUE DE SOUDEUR AUTOMATIQUE TEINTE 11 PORTE FILTRE 110 X 90 CM EQUIPE DE CASQUE DE CHANTIER EN ABS - POIDS COMPLET 644 G

RÉF. ART.

EP008463

MASQUE DE SOUDEUR AUTOMATIQUE CHAMELEON 3VO

WELDINE



we
life

Dédié aux travaux courants à l'électrode enrobée ou en MIG/MAG. Champ de vision 97 x 40 mm. Teinte variable DIN 4 - DIN 9-13. Temps de réaction : clair -> sombre 1/12000 sec, sombre -> clair 0,1 à 1 sec. 2 capteurs assistés de 2 piles AAA. Masque livré avec 5 écrans de protection extérieurs, 2 écrans intérieurs traités anti-buée, 1 bandeau anti-transpiration et 1 coussin de confort sur serre-tête.

RÉF. ART.

EP002851

MASQUE DE SOUDEUR SAF - AIGLON - EN POLYESTER



POLYESTER ARME FIBRE DE VERRE

RÉF. ART.

EP002852

photos non contractuelles

MASQUE DE SOUDAGE 3M SPEEDGLASS

9100

3M

RÉF. ART.
EP007983

MASQUE DE SOUDAGE 3M SPEEDGLAS

9100XX M ADFLO + CASQUE

3M

we
life

RÉF. ART.
EP018748

SYSTEME ADFLO COMPLET

3M

we
life

RÉF. ART.	DESCRIPTION
EP020822	- 1 BLOC MOTEUR - 1 TUYAU RESPIRATOIRE

CASQUE P/SYSTEME VERSAFLO-ADFLO-
JUPITER-JOINT FACI.CONFORT**3M**

we
life

CASQUE POUR SYSTEME VERSAFLO-ADFLO-JUPITER-JOINT
FACI.CONFORT

RÉF. ART.
EP020821

**PREFILTRE ADFLO POUR MASQUE
SOUDAGE SPEEDGLASS(SACHET DE 5)**

3M



we
life

RÉF. ART.
EP020824

**FILTRE ADFLO ABE1 (CARTON DE 1
FILTRE)**

3M



we
life

RÉF. ART.
EP020831

FILTRE ADFLO A2 (CARTON DE 1 FILTRE)

3M



we
life

RÉF. ART.
EP020833

**FILTRE P POUR SYSTEME ADFLO
(CARTON DE 2 FILTRES)**

3M



we
life

RÉF. ART.
EP020825

photos non contractuelles

**BATTERIE STANDARD LI-ION POUR
SYSTEME ADFLO****3M**we
life

RÉF. ART.

EP020834

**CHARGEUR INTELLIGENT POUR SYSTEME
ADFLO ET VERSAFLO****3M**we
life

RÉF. ART.

EP020835

ANTI-REFLET SUR POLYCARBONATE

BOLLE SAFETY

BOLLE SAFETY - Prestation de lunettes de sécurité à la vue

RÉF. ART.

PR008793

ANTI-REFLET SUR VERRE CR39

BOLLE SAFETY

BOLLE SAFETY - Prestation de lunettes de sécurité à la vue

RÉF. ART.

PR008817

LUNETTES PHOTOCHROMIQUE CR39

BOLLE SAFETY

BOLLE SAFETY - Prestation de lunettes de sécurité à la vue

RÉF. ART. DESCRIPTION

PR008815 LUNETTES PHOTOCHROMIQUE CR39 BIFOCAL D.28MM

LUNETTES PHOTOCHROMIQUE CR40

BOLLE SAFETY

BOLLE SAFETY - Prestation de lunettes de sécurité à la vue

RÉF. ART. DESCRIPTION

PR008816 LUNETTES PHOTOCHROMIQUE CR39 PROGRESSIVE STANDARD

LUNETTES PHOTOCHROMIQUE CR41

BOLLE SAFETY

BOLLE SAFETY - Prestation de lunettes de sécurité à la vue

RÉF. ART. DESCRIPTION

PR008814 LUNETTES PHOTOCHROMIQUE CR39 UNIFOCAL

LUNETTES PHOTOCHROMIQUE POLYCARBONATE

BOLLE SAFETY

BOLLE SAFETY - Prestation de lunettes de sécurité à la vue

RÉF. ART. DESCRIPTION

PR008789 BIFOCAL D.28MM

PR008790 PROGRESSIVE STANDARD

PR008788 UNIFOCAL

LUNETTES OCULAIRES CR39 TRAITÉS

BOLLE SAFETY

BOLLE SAFETY - Prestation de lunettes de sécurité à la vue

RÉF. ART. DESCRIPTION

PR008805 ANTI-RAYURES BIFOCAL D.28MM

PR008812 ANTI-RAYURES PROGRESSIF STD

PR008804 ANTI-RAYURES UNIFOCAL

LUNETTES OCULAIRES POLYCARBONATE ANTI-RAYURES

BOLLE SAFETY

BOLLE SAFETY - Prestation de lunettes de sécurité à la vue

RÉF. ART. DESCRIPTION

PR008784 BIFOCAL D.28MM

PR008786 PROGRESSIF STD

PR008783 UNIFOCAL

PRISME PAR VERRE

BOLLE SAFETY

BOLLE SAFETY - Prestation de lunettes de sécurité à la vue

RÉF. ART. DESCRIPTION

PR008822 EN MATIÈRE CR9

PR008801 EN MATIÈRE POLYCARBONATE

TEINTE POLYCARBONATE BRUN OU GRIS

BOLLE SAFETY

BOLLE SAFETY - Prestation de lunettes de sécurité à la vue

RÉF. ART.

PR008795

TEINTE VERRE CR39 BRUN OU GRIS

BOLLE SAFETY

BOLLE SAFETY - Prestation de lunettes de sécurité à la vue

RÉF. ART.

PR008820

VERRE CR39 EXTRA PUISSANTE

BOLLE SAFETY

BOLLE SAFETY - Prestation de lunettes de sécurité à la vue

RÉF. ART. DESCRIPTION

PR008824 > -8 OU +8

PR008803 > -8 OU +8 EN POLYCARBONATE

PROCESS CONTACT

DISTRIMO



RÉF. ART. DESCRIPTION

PRESTATION mailto:a.owczarzak@bouygues-construction.com

photos non contractuelles

DEMI MASQUE 4279 POUR VAPEURS GAZ ACIDES 3M

3M



we
life

RÉF. ART.	DESCRIPTION
EP007986	DEMI MASQUE 3M 4279 POUR VAPEURS GAZ ACIDES

DEMI MASQUE 4255 GAZ ET VAPEUR 3M

3M



we
life

Masque de protection avec 2 grands filtres à charbon actif reliés. Soupape parabolique à faible résistance respiratoire pour réduire la chaleur à l'intérieur du masque. Fixation réglable pour un maintien stable. Aucune maintenance.

RÉF. ART.	DESCRIPTION
EP007985	DEMI MASQUE GAZ ET VAPEUR 3M 4255 FFA2P3D

DEMI MASQUE D'EVACUATION 5 MIN AVEC PINCE NEZ

MSA FRANCE

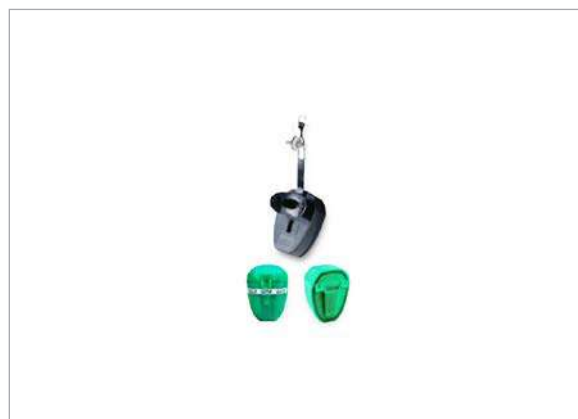

we
life

Appareil d'évacuation à usage unique, d'une utilisation limitée à 5min, il est muni d'un embout buccal et d'un pince nez. Pour gaz et vapeurs toxiques. Petit, léger et compact, il est porté à la ceinture, prêt à l'emploi.

RÉF. ART.	DESCRIPTION
EP003245	- MINISCAPE

DEMI MASQUE EVACUATION 15 MIN MSR2

MSA FRANCE



we
life

RÉF. ART.	DESCRIPTION
EP018663	DEMI MASQUE EVACUATION MSR2 15 MIN + 2 FILTRES P2

DEMI MASQUE FORCE 8 PRESS TO CHECK



we
life

Le demi masque force 8 Press to Check est une nouvelle technologie qui permet à l'utilisateur de vérifier que son demi-masque est correctement positionné et ajusté. Ce demi masque est composé de filtres P3 RD Press to Check et d'une pièce faciale en élastomère thermoplastique rembourré pour plus de confort lors d'un port prolongé et prenant la forme du visage pour une excellente

RÉF. ART.	DESCRIPTION
EP010627	- VALVE TYPHOON

FILTRE A2P3 DEMI MASQUE FORCE 8 PRESS TO CHECK



we
life

Cartouche A2P3 pour demi masque force 8 Press to Check. Performance du filtre : A = Gaz et vapeurs organiques dont le point d'ébullition est supérieur à 65° C - 2 = capacité d'efficacité d'un filtre anti-gaz = moyenne (existe en 3 classes) - P3 = Protection contre la poussière. Arrêtent au moins 99,95 % de cet aérosol (soit une pénétration inférieure à 0,05%)

RÉF. ART.	DESCRIPTION
EP010659	FILTRE A2P3 POUR DEMI MASQUE PRESS TO CHECK (LA PAIRE)

FILTRE P3R POUR DEMI MASQUE FORCE 8 PRESS TO CHECK



we
life

Cartouche P3R pour demi masque force 8 Press to Check Performance du filtre EN14387:2004 Performance du filtre EN143:2000

RÉF. ART.	DESCRIPTION
EP010628	FILTRE P3R POUR DEMI MASQUE PRESS TO (LA PAIRE)

FILTRE ABEK1P3 POUR DEMI MASQUE FORCE 8 PRESS TO CHECK



we
life

RÉF. ART.	DESCRIPTION
EP010660	FILTRE ABEK1P3 POUR DEMI MASQUE PRESS TO CHECK (LA PAIRE)

photos non contractuelles

CEINTURE VENTILATION ASSISTEE -COMPACT AIR

HONEYWELL



MASQUE COMPACT AIR AVEC CEINTURE SPECIAL PLOMB

RÉF. ART.

EP001794

FILTRE A2P3 POUR COMPACT AIR

HONEYWELL



MASQUE COMPACT AIR
FILTRE RD40 AL - A2P3 POUR DEMI MASQUE COMPACT AIR -
UNITE

RÉF. ART.

DESCRIPTION

EP008523

FILTRE A2P3 POUR DEMI MASQUE COMPACT AIR - UNITE

DEMI MASQUE POUR CEINTURE COMPACT AIR

HONEYWELL



MASQUE COMPACT AIR
DEMI MASQUE SILICONE N7700 RD 40 POUR CEINTURE
COMPACT AIR TAILLE M OU L

RÉF. ART.

DESCRIPTION

TAILLE

EP008411M

TAILLE M -

M

EP008411L

TAILLE L

L

FILTRE P3 POUR COMPACT AIR

HONEYWELL



MASQUE COMPACT AIR

RÉF. ART.

DESCRIPTION

EP005089

FILTRE P3 POUR MASQUE COMPACT AIR

photos non contractuelles

MASQUE ANTI POUSSIERE FFP3**3M**we
life

Avec soupape expiratoire. Assure une protection optimale contre les particules grâce à son nouveau média-filtrant, qui permet un meilleur confort respiratoire, à sa barrette nasale qui permet une meilleure étanchéité et à son panneau nasal sculpté qui améliore la compatibilité avec le port des lunettes. Emballage individuel.

RÉF. ART.	DESCRIPTION
EP009172	S 3M AURA 9332+
EP005227	MASQUE ANTI-POUSSIERE FFP3V AVEC SOUPAPE

MASQUE COMPLET SERIE 9000

MOLDEX

we
life

MASQUE COMPLET TAILLE L Pièce faciale en thermoplastique anallergique TPE, répartition optimale de la tension des brides, oculaire panoramique en polycarbonate traité anti-rayures et hydrophobe pour un essuyage facile. Grande vision périphérique : perception des mouvements latéraux. Manipulation très aisée car combinaison possible avec 2 éléments seulement. Poids : 360g, 595g avec les filtres ABEK.

RÉF. ART.	DESCRIPTION
EP002850L	TAILLE L
EP002850M	TAILLE M

PAIRE FILTRE A PARTICULE P3RD POUR MASQUE SERIE 7000-9000

MOLDEX

we
life

MASQUE SERIE 9000_DEMI MASQUE SERIE 7000
FILTRÉ & PREFILTRÉ A PARTICULES P3 RD Type de polluants :

Toutes poussières, fumées et brouillard dont la phase liquide est l'eau ou l'huile

RÉF. ART.
EP005086

PAIRE FILTRE ANTIGAZ POUR MASQUE SERIE 7000-9000

MOLDEX

we
life

MASQUE SERIE 9000_DEMI MASQUE SERIE 7000
FILTRÉ ANTI-GAZ ABEK1 Type de polluants : Gaz et vapeurs organiques point d'ébullition > 65°C + gaz et vapeurs inorganiques + gaz acides point d'ébullition > 65°C + ammoniac point d'ébullition > 6°C Limite d'utilisation : 6 mois après ouverture dans un sac plastiques – Préciser sur le sac la dat de 1ère utilisation

RÉF. ART.	DESCRIPTION
EP005085	PAIRE FILTRÉ ANTIGAZ ABEK1 POUR MASQUE SERIE 7000-9000

photos non contractuelles

**CASQUETTE+ECRAN+FILTRES
POEWERCAP VENTILEE TH1**



MULTI PLUG BLACK

RÉF. ART.	DESCRIPTION
EP010346	CASQUETTE+ECRAN+FILTRES TH1P POWERCAP ACTIVE IP 8HR

**SANBUE LANGUETTE ANTI GLISSE POUR
MASQUE CHIRURGICAL (LOT DE 100
PIECES)**



RÉF. ART.	DESCRIPTION
EP105987	SANBUE LANGUETTE ANTI GLISS POUR MASQUE CHIRURGICAL (LOT DE 100 PIECES)

**PINCE MI - BARRETTE NASALE DE
MAINTIEN ANTI-BUEE**

POUR ÉVITER LA BUÉE SUR LES LUNETTES LORS DU PORT DU MASQUE -
SACHET DE 100 UNITÉS



RÉF. ART.	DESCRIPTION
EP101613	(PAR 100)

photos non contractuelles

MASQUE COMPLET CLEANSPACE ULTRA

CLEANSPACE

we
life

POUR TRAVAUX DESAMIANTAGE

RÉF. ART.	DESCRIPTION
EP018252	(SANS BLOC MOTEUR)

FILTRE PARTICULE CLEANSPACE 2

CLEANSPACE

we
life

POUR TRAVAUX DESAMIANTAGE

RÉF. ART.	DESCRIPTION
EP018254	TM3P HEPA (PACK DE 3)

**SYSTEME MOTOR CLEANSPACE ULTRA
DECONTAMINABLE**

CLEANSPACE

we
life

POUR TRAVAUX DESAMIANTAGE

RÉF. ART.
EP018253

PREFILTRE CLEANSPACE 2

CLEANSPACE

we
life

POUR TRAVAUX DESAMIANTAGE

RÉF. ART.	DESCRIPTION
EP018255	(PACK DE 10)

photos non contractuelles

HOUSSE DE PROTECTION MOTEUR POUR CLEANSPACE ULTRA

CLEANSPACE



we  life

POUR TRAVAUX DESAMIANTAGE

RÉF. ART.	DESCRIPTION
EP018257	- PAR 25

BOUCHON POUR DECONTAMINATION POUR CLEANSPACE ULTRA

CLEANSPACE



we  life

POUR TRAVAUX DESAMIANTAGE

RÉF. ART.	DESCRIPTION
EP018256	

MASQUE PANORAMIQUE CLEANAIR SHIGEMATSU

LAPRO



we  life

Le STS GX02 est le masque haut de gamme de CleanAIR. Grâce au champ de vision panoramique de sa visière sphérique, une ergonomie autorisant un parfait ajustement, et ses trois tailles S, M et L, il offre un très grand confort, sans compromis de sécurité. Compatibilité : CleanAIR Amiante, Chemical 2 F Plus, Chemical 3F Plus et filtration passive Matériaux : silicone, polycarbonate, caoutchouc Taille : L - Existe aussi en taille S et en taille M Poids : 610 g Filetage cartouche/tuyau : DIN 40 mm F

RÉF. ART.	DESCRIPTION
EP104625M	GX02 TAILLE M
EP0104625L	GX02 TAILLE L

CEINTURE HYPALON POUR CLEANAIR CHEMICAL

LAPRO



we  life

SANS MASQUE NI TUYAU Le Chemical 2F Plus s'impose comme le moteur référence. Il a été le fruit de plus de 3 ans de développement nés de retours utilisateurs, et avec deux uniques préoccupations : confort et sécurité. Jugez plutôt : débit d'air constant réglable de 160 à 210 l/mn, soupapes exclusives de fermeture des conduits en l'absence de filtre afin d'éviter toute contamination, gestion électronique intégrale via un large écran de contrôle LCD couleur à affichage intuitif, poids de seulement

RÉF. ART.	DESCRIPTION
EP104627	2F PLUS

BATTERIE LI-ION 14,4 V 2,6AH POUR CLEANAIR CHEMICAL

LAPRO



Batterie de remplacement pour le moteur filtrant CleanAIR Chemical 2F Plus à technologie Li-Ion. D'une durée de vie de 500 cycles et d'une capacité de 2 600 mAh, elle se charge en 2 h 30 et offre, avec des filtres P3, une autonomie de plus de 8 h 30 au débit de 160 l/mn. Li-Ion rechargeable 2,6 Ah, 14,4 V Temps de charge : 2 h 30 Autonomie : variable selon la pièce faciale, le débit et le type de filtres utilisés. Compatibilité : moteur filtrant CleanAIR Chemical 2F Plus Type : amovible Technolo

RÉF. ART.	DESCRIPTION
EP104631	2F PLUS

TEST D'ETANCHEITE ET IDENTIFICATION

LAPRO

Un test d'étanchéité est effectué avant la mise à disposition de chacun de nos masques. Il certifie le bon état et l'étanchéité des pièces faciales.

RÉF. ART.	DESCRIPTION
EP104626	INCLUANT CERTIFICAT

TUYAU CAOUTCHOUC 90° A SERRE JOINTS

LAPRO



Tuyau d'air : souple, semi-rigide et flexible, longueur 50 cm extensible à 1 m, connecteur type Rd40 pour ceinture HYPALON

RÉF. ART.	DESCRIPTION
EP104628	CA 2F PLUS 900MM

FILTRE P3 POUR CLEANAIR CHEMICAL

LAPRO



Cartouche filtrante P3 pour les moteurs à ventilation assistée CleanAIR Chemical 2F Plus et 3F Plus et, en filtration passive, pour les masques complets CleanAIR GX02, CF02 et le demi-masque CleanAIR CA-5. Certification : EN 143, EN 12941, EN 12942 Compatibilité ventilation assistée : moteurs filtrants CleanAIR Chemical 2F & 3F Plus Compatibilité filtration passive : masques CleanAIR GX02 et CF02 et demi-masque CleanAIR CA-5 Applications : fumées toxiques, particules, aérosols solides et liquide

RÉF. ART.	DESCRIPTION
EP104630	FILTRE P3 DIN 40 POUR CLEANAIR CHEMICAL 2F PLUS(CARTON DE 6)

VALISE CLEANAIR

LAPRO



Valise de transport en PVC noir renforcé, à poignée, permettant de ranger un système complet de protection respiratoire incluant le masque, le moteur et quelques accessoires (lingettes et quelques combinaisons). Dimensions : 420 x 160 x 335 mm Matériau : PVC Compatibilité : systèmes complets de protection respiratoire (masque, moteur et accessoires)

RÉF. ART.	DESCRIPTION
EP104629	420X305X155 MM POUR TOUS SYSTEMES

photos non contractuelles

COMBINAISON JETABLE BLANCHE TYVEK CAT 3

 Tyvek



 we life

TYPES 5 ET 6 - + RESISTANT - Vêtement à usage limité. Combinaison à capuche en Tyvek. Élastique à la taille, poignée, visage et chevilles. Poches auto adhésives. Fermeture à glissière. TYVEK 41GR M² TYPE 5-6 CAT.III Risques chimiques : types 5 et 6 - Protection contre les particules radioactives - Traitement antistatique 41GR M² TYPE 5-6 CAT.III

RÉF. ART.	DESCRIPTION	TAILLE	COULEUR
EP008239BCL	COMBINAISON JETABLE BLANCHE TYVEK L CAT 3	L	BLANC
EP008239BCXL	COMBINAISON JETABLE BLANCHE TYVEK XL CAT 3	XL	BLANC
EP008239BC2XL	COMBINAISON JETABLE BLANCHE TYVEK 2XL CAT 3	XXL	BLANC

COMBINAISON JETABLE BLEUE TYVEK CAT 3

 Tyvek



 we life

PRODUIT SUSCEPTIBLE D'ETRE EN RUPTURE EXCEPTIONNELLEMENT (crise sanitaire) TYPES 5 ET 6 - + RESISTANT - Vêtement à usage limité. Combinaison à capuche en Tyvek. Élastique à la taille, poignée, visage et chevilles. Poches auto adhésives. Fermeture à glissière. TYVEK 41GR M² TYPE 5-6 CAT.III Risques chimiques : types 5 et 6 - Protection contre les particules radioactives - Traitement antistatique 41GR M² TYPE 5-6 CAT.III

RÉF. ART.	DESCRIPTION	TAILLE	COULEUR
EP008239BLL	COMBINAISON JETABLE BLEUE TYVEK L CAT 3	L	BLEU
EP008239BLXL	COMBINAISON JETABLE BLEUE TYVEK XL CAT 3	XL	BLEU
EP008239BL2XL	COMBINAISON JETABLE BLEUE TYVEK 2XL CAT 3	XXL	BLEU

photos non contractuelles

COMBINAISON JETABLE BLANC CAT 3

COVERGUARD



Risques chimiques : types 4, 5 et 6 - Protection contre les particules radioactives - Traitement antistatique - Etanche aux agents biologiques

RÉF. ART.	DESCRIPTION	TAILLE	COULEUR
EP008238BCL	-TYPE 4,5,6 - + CONFORT L	L	BLANC
EP008238BCXL	-TYPE 4,5,6 - + CONFORT XL	XL	BLANC
EP008238BC2XL	-TYPE 4,5,6 - + CONFORT 2XL	XXL	BLANC

COMBINAISON JETABLE BLANCHE CAT 3

COVERGUARD



Risques chimiques : types 5 et 6 - Protection contre les particules radioactives - Traitement antistatique

RÉF. ART.	DESCRIPTION	TAILLE	COULEUR
EP008237BCL		L	BLANC
EP008237BCXL	- TYPES 5 ET 6	XL	BLANC
EP008237BC2XL		XXL	BLANC

photos non contractuelles

SUR BOTTES SEMELLE CAOUTCHOUC

 Tyvek





RÉF. ART.	DESCRIPTION
EP018250	ANTIDERAPANTE TYVEK CART 100 PAIRES

GANT LATEX VITAL 124

 MAPA





RÉF. ART.	TAILLE
EP009031T6	T06
EP009031T7	T07
EP009031T8	T08
EP009031T9	T09
EP009031T10	T10

SUR CHAUSSURE ANTI-DERAPANTE





RÉF. ART.	DESCRIPTION
EP007043	CART 250 PAIRES

photos non contractuelles

GANT (SOUS GANTS) TEXTILE

COVERGUARD

we
life

RÉF. ART.	DESCRIPTION
EP005111	SOUS GANTS TEXTILE TRICOTE TO

GANT ANTI FROID - LIGHT COLD TAILLE UNIQUE

LEBON

we
life

Risques mécaniques : 0

RÉF. ART.	DESCRIPTION
EP005110	SOUS GANTS ANTI FROID - LIGHT COLD TAILLE UNIQUE

GANT KRYTECH 586

MAPA

we
life

EN388 : 4X43D - Gants en Polyuréthane. Support tricoté sans couture à base de fibres PEHD. Dos aéré. Longueur variant de 24 à 30cm selon la taille. Poignet tricot. Excellente dextérité grâce au gantage proche de la main. Confort et souplesse. Teinte du textile en bleu, qui permet d'identifier facilement le niveau de protection à la coupure.

RÉF. ART.	DESCRIPTION	TAILLE
EP008084T6		T06
EP008084T7		T07
EP008084T8		T08
EP008084T9	- RESISTANT COUPURE INDICE 5 - GRIS	T09
EP008084T10		T10
EP008084T11		T11

photos non contractuelles

GANT KRYTECH 582 ENDUCTION DOS NITRILE NOIR

MAPA



we
life

EN388 : 4X43D - Protection haute performance pour les manipulations fines en milieu huileux. Revêtement spécial GRIP&PROOF à base de nitrile pour une meilleure étanchéité et un très bon grip aux contacts huileux. Excellente résistance à l'abrasion : Durabilité supérieure. Indicateur visuel du niveau de protection (textile bleu) pour une meilleure identification sur le lieu de travail. Longueur variant de 23 à 27cm selon la taille. Poignet tricot. Finition intérieure : support tricoté sans couture

RÉF. ART.	DESCRIPTION	TAILLE
EP008417T8		T8
EP008417T9	I.COUPURE 5	T09
EP008417T10		T10

GANT ANTI COUPURE D

SHOWA



we
life

EN388 : 4X41D - Fibre haute technologie excellente résistance aux coupures. MAnchette solide et robuste qui recouvre le poignet. Revêtement en fibre nitrilée doublée d'une couche de nitrile en mousse au niveau de la paume. Modèle sans couture.

RÉF. ART.	DESCRIPTION	TAILLE
EP100483S		S
EP100483M		M
EP100483L	- S-TEX 377 SC	L
EP100483XL		XL
EP1004832XL		XXL
EP100482S	- S-TEX 377	S
EP100482M	- S-TEX 378	M
EP100482L	- S-TEX 379	L
EP100482XL	- S-TEX 380	XL
EP1004822XL	- S-TEX 381	XXL

GANT WINTERSAFE ANTI-COUPURE PROTECTION CONTRE LE FROID

LEBON

we
life

EN388 : 4X42X - Gant enduit ¾ en PVC adhésié sur support tricoté 100% filament haute performance, poignet élastique, doublure isolante totale 100% acrylique. Très bonne résistance au froid de contact (-20°C). L'enduction 3/4 en PVC offre une excellente étanchéité à l'humidité, aux huiles et graisses. EN388 : 4542 - EN511 : 02X

RÉF. ART.	TAILLE
EP010576T7	T07
EP010576T8	T08
EP010576T9	T09
EP010576T10	T10
EP010576T11	T11

GANT VEGA 27 COUPURE 3

LEBON

we
life

EN388 : 4X43B - Gant tout enduit nitrile mousse coloris noir sur support tricoté jauge 13 sans couture en filament 100% polyéthylène haute densité et fil 100% polyamide texturé coloris gris, longueur 27 cm. De la T.7 à T.10

RÉF. ART.	DESCRIPTION	TAILLE
EP010344T7		T07
EP010344T8	ETANCHE	T08
EP010344T9		T09
EP010344T10		T10

GANT POWERFIT 4-3-4-3 DEXTERITE 5

LEBON

we
life

EN388 - 4343B - Gant tricoté en filament 100% polyéthylène POWERFIT - Dextérité 5, effet seconde peau - Résistance mécanique : 4-3-4-3. 0 Prix à l'unité - Conditionnement possible par 10

RÉF. ART.	TAILLE
EP005539T8	T08
EP005539T9	T09
EP005539T10	T10
EP005539T11	T11
EP005539T12	T12

GANT MANUTENTION FIN GRIS ULTRANE 551

MAPA

we
life

EN388 : 4131X - UNIQUEMENT POUR TRACAGE ET VISITEUR

RÉF. ART.	DESCRIPTION	TAILLE
EP008088T7		T07
EP008088T8		T08
EP008088T9	- PAS DE PROTECTION COUPURE	T09
EP008088T10		T10

photos non contractuelles

GANT TACTILE FEELPRO

ROSTAING

we
life

EN388 : 4121X - UNIQUEMENT POUR TRACAGE ET VISITEURS

RÉF. ART.	DESCRIPTION	TAILLE
EP020303T7		T07
EP020303T8		T08
EP020303T9	- PAS DE PROTECTION COUPURE -	T09
EP020303T10		T10
EP020303T11		T11

GANT ALPHATEC A MANCHETTE

ANSELL

we
life

RÉF. ART.	TAILLE
EP008243T09	T09
EP008243T10	T10

GANT CIMENTIER BLEU NEOPRENESINGER
safetywe
life

Risques mécaniques : 2-1-3-1

RÉF. ART.	TAILLE
EP005113T6	T6
EP005113T7	T7
EP005113T8	T8
EP005113T9	T9
EP005113T10	T10

GANT CHIMIQUE PVC 40 CM SUPER ACTIFRESH -

COVERGUARD

we
life

GANT PRODUIT CHIMIQUE Risques mécaniques : Abrasion 4 Tranchage 1 Déchirure 2 Perforation 1. Gant PVC rouge. Finition lisse. Support coton interlock. Manipulations en milieux agressifs: huiles, graisses, produits chimiques, hydrocarbures. Industrie chimique et pétrochimique. La composition du PVC a été adaptée pour les manipulations multi-usages et répétitives en milieu huileux.

RÉF. ART.	DESCRIPTION	TAILLE
EP005680T10	GANT CHIMIQUE PVC 40 CM SUPER ACTIFRESH	T10

GANT CHIMIE NEOPRENE

COVERGUARD

we
life

Gant ultra moulant de la main à l'avant bras - Résistant au sodium hydroxyde (40%) - Très résistant à l'acide sulfurique (96%) - Résistant à l'heptane - Risques mécaniques : 2-1-2-1

RÉF. ART.	TAILLE
EP008246T09	T09
EP008246T10	T10

GANT CHIMIE NITRIL VERT

COVERGUARD

we
life

RÉF. ART.	TAILLE
EP008247T7	T07
EP008247T8	T08
EP008247T9	T09
EP008247T10	T10

GANT LATEX VITAL 124

MAPA

we
life

RÉF. ART.	TAILLE
EP009031T6	T06
EP009031T7	T07
EP009031T8	T08
EP009031T9	T09
EP009031T10	T10

GANT CAOUTCHOUC NATUREL

ANSELL

we
life

GANT UNIVERSAL PLUS - 1 paire de GANTS A MANCHETTE JETABLES. Gants en latex naturel 100 %, finition suédée, halogénisée. Adhéré écaillés, longueur 30,5 cm. Epaisseur 0,4 mm. Sanitized. Cat.3 6 Risques mécaniques : X-0-1-0 - Protection contre les particules radioactives et les agents biologiques - Faible protection contre les produits chimiques - Imperméable à l'eau

RÉF. ART.	TAILLE
EP008245T9	T09
EP008245T10	T10

photos non contractuelles

GANT CUIR PEUCEROS

PEUCEROS

we
life

GANT MANUTENTION CUIR PEUCEROS Risques mécaniques : Abrasion 2 Tranchage 1 Déchirure 2 Perforation 1. Gant en flanc de vachette pleine fleur hydrofuge vert. Coupe américaine, pouce palmé. Index d'une seule pièce Ajoutage sur le dos effectué à la double aiguille.

RÉF. ART.	DESCRIPTION	TAILLE
EP005555T8		T08
EP005555T9		T09
EP005555T10	- EN388 - 2121	T10
EP005555T11		T11

GANT CUIR F27

LEBON

we
life

Risques mécaniques : 2-1-2-2

RÉF. ART.	TAILLE
EP008248T9	T09
EP008248T10	T10
EP008248T11	T11

GANT CUIR HAUTE PRESSION

ROSTAING

we
life

RÉF. ART.	TAILLE
EP008249T9	T09
EP008249T10	T10
EP008249T11	T11

GANT SOUDEUR TIGwe
life

RÉF. ART.	DESCRIPTION	TAILLE
EP008858	MANCHETTE DE 15 CM	T10

GANT SOUDEUR CUIR INTERIEUR MOLLETONNE

COVERGUARD

we
life

RÉF. ART.
EP002333

photos non contractuelles

GANT ISOLANT LATEX POUR TRAVAUX TST 500V



GANT ISOLANTS TST - Pour travaux TST 500V - CL00 Gant isolant en latex naturel beige Classe 00 Bord Tranché Catégorie AZC Sa forme ergonomique et son intérieur légèrement poudré facilite la mise en main et le retrait. La structure à base de latex naturel procure de hautes caractéristiques diélectriques. Son épaisseur (0.5mm) assure une bonne dextérité tout en protégeant jusqu'à 500 Volts. SECURITE Il doit être utilisé avec un surgant en cuir.

RÉF. ART.	DESCRIPTION	TAILLE
EP008081T7		T07
EP008081T8		T08
EP008081T9	GANT ISOLANT LATEX - POUR TRAVAUX TST 500V - CL00	T09
EP008081T10		T10
EP008081T11		T11

GANT ISOLANT LATEX POUR TRAVAUX TST 1000V



GANTS ISOLANTS TST - Pour travaux TST 1000V - CL0 Gant isolant en latex naturel beige. Classe 0. Bord Tranché. Catégorie RC. Sa forme ergonomique et son intérieur légèrement poudré facilite la mise en main et le retrait. La structure à base de latex naturel procure de hautes caractéristiques diélectriques. Son épaisseur (1mm) assure une bonne dextérité tout en protégeant jusqu'à 1000 Volts. SECURITE Il doit être utilisé avec un surgant en cuir.

RÉF. ART.	DESCRIPTION	TAILLE
EP008079T8		T08
EP008079T9	GANT ISOLANT LATEX - POUR TRAVAUX TST 1000V - CL0	T09
EP008079T10		T10
EP008079T11		T11

photos non contractuelles

GANT ISOLANT LATEX POUR TRAVAUX TST 7500V



we
life

GANT ISOLANTS TST - Pour travaux TST 7500V - CL1 Gant isolant en latex naturel beige Classe 1 Bord Tranché Catégorie AZC Sa forme ergonomique et son intérieur légèrement poudré facilite la mise en main et le retrait. La structure à base de latex naturel procure de hautes caractéristiques diélectriques. Son épaisseur (0.5mm) assure une bonne dextérité tout en protégeant jusqu'à 500 Volts. SECURITE II doit être utilisé avec un surgant en cuir.

RÉF. ART.	DESCRIPTION	TAILLE
EP008082T8		T08
EP008082T9	GANT ISOLANT LATEX - POUR TRAVAUX TST 7500V	T09
EP008082T10	- CL1	T10
EP008082T11		T11

GANT ISOLANT LATEX POUR TRAVAUX TST 26500V



we
life

RÉF. ART.	DESCRIPTION	TAILLE
EP008080T9		T09
EP008080T10	GANT ISOLANT LATEX - POUR TRAVAUX TST 26500V - CL3	T10
EP008080T11		T11

GANT ISOLANT TST COMPOSITE 500V



we
life

Gant isolant en latex naturel flocké coton. Extérieur en polychloroprène orange. Protection mécanique de catégorie RC. Epaisseur & 8 mm. Il peut être utilisé sans surgant cuir grâce à sa combinaison avec un élastomère mécaniquement plus résistant.

RÉF. ART.	TAILLE
EP008416T7	T07
EP008416T8	T08
EP008416T9	T09
EP008416T10	T10
EP008416T11	T11

GANT ISOLANT TST COMPOSITE 1000V



we
life

RÉF. ART.	TAILLE
EP017919T8	8
EP017919T9	9
EP017919T10	10
EP017919T11	11

photos non contractuelles

SURGANT TST OVERGLOVE HAUTE TENSION

CATU



we
life

Article conçu pour protéger mécaniquement les gants électrique haute tension : 20 KV. Surgant en cuir fleur de bovin jaune. Traitement silicone et hydrofuge. Coupe américaine, pouce palmé, type crispin. Bande d'ajustement Velcro sur le dos. Manchette rapportée de 120 mm. La patte de serrage par Velcro assure un bon maintien du gant. La coupe américaine, le pouce palmé et la souplesse des matériaux utilisés rendent ce gant ergonomique et offrent un excellent confort d'utilisation. Le cuir fleur

RÉF. ART.	TAILLE
EP008149T8	T08
EP008149T9	T09
EP008149T10	T10
EP008149T11	T11

GANT POUR UTILISATION DE MAT. VIBRANT

ANSELL



we
life

GANTS POUR L'UTILISATION DE MATERIEL VIBRANT - ANSELL VibraGuard Risques mécaniques : Abrasion 3 Tranchage 2 Déchirure 2 Perforation 3. Protection complète des doigts, totalement enduit avec Velcro, fermeture type gant de golf. doigts. Longueur 240mm Atténuation des vibrations : EN10819

RÉF. ART.	TAILLE
EP008085T8	T08
EP008085T9	T09
EP008085T10	T10

GANT POUR UTILISATION DE MATERIEL VIBRANT ROSTAING

ROSTAING



we
life

Risques mécaniques : X-2-4-3

RÉF. ART.	TAILLE
EP005536T8	T08
EP005536T9	T09
EP005536T10	T10

GANT MENAGE



RÉF. ART.
EP007912

photos non contractuelles

GANT LATEX CONFORM+ (boîte de 100)

COVERGUARD

we
life

RÉF. ART.

EP007821

GANTS JETABLES VYNIL - BOITE DE 100 GANTS

MAPA

we
life

Risques mécaniques : X-2-4-4

RÉF. ART.

EP005123

GANT ELAGUEUR ANTI COUPUREwe
life

RÉF. ART.	DESCRIPTION	TAILLE
EP010568T8		T08
EP010568T9		T09
EP010568T10	AVEC RENFORT MAIN GAUCHE	T10
EP010568T11		T11
EP010568T12		T12

MANCHETTE FIL KEVLAR

HONEYWELL

we
life

Manchette tricoté en fil Kevlar double épaisseur, passage pour le pouce - Longueur 36cm - Risques mécaniques : 1-3-2-X - Résistance thermique de contact jusqu'à 100°C

RÉF. ART.

EP002780

ACCROCHE GANT DOUBLE NOIR



RÉF. ART.	DESCRIPTION
EP100565	3400

TESTEUR POUR GANT ELECTRICIEN



we
life

Vérificateur pneumatique pour contrôle obligatoire des gants isolants

RÉF. ART.
EP007796

VERIFIEZ LA DISPONIBILITE DE NOS PRODUITS

DISTRIMO



En scannant le QR code, vérifiez le stock des produits à l'aide des références et de la barre de recherche

RÉF. ART.	DESCRIPTION
SITE WEB	http://distrimo.bouygues-construction.com/

photos non contractuelles

GILET ANTI FROID DOS LONG

FERMETURE À GLISSIÈRE. 2 POCHE PROFONDES PLAQUÉES. 1 POCHE POITRINE STYLO. 1 POCHE POITRINE AVEC RABAT À BANDE AGRIPPANTE. 2 POCHE À L'INTÉRIEUR, DONT 1 POCHE TÉLÉPHONE AVEC RABAT À BANDE AGRIPPANTE. BAS DU GILET ÉLASTIQUE. PORTÈGE-REINS COMPOSITION: DESSUS: 65% POLYESTER - 35% COTON. DOUBLURE ET REMPLISSAGE: 100% POLYESTER



RÉF. ART.	TAILLE	COULEUR
EP008090BMS	S	BLEU
EP008090BMM	M	BLEU
EP008090BML	L	BLEU
EP008090BMXL	XL	BLEU
EP008090BM2XL	XXL	BLEU
EP008090BM3XL	XXXL	BLEU

GILET ANTI FROID DOS LONG BY BAT GO



Fermeture à glissière. 2 poches profondes plaquées. 1 poche poitrine stylo. 1 poche poitrine avec rabat à bande agrippante. 2 poches à l'intérieur, dont 1 poche téléphone avec rabat à bande agrippante. Bas du gilet élastique. Portège-reins Composition: Dessus: 65% polyester - 35% coton. Doublure et remplissage: 100% polyester

RÉF. ART.	DESCRIPTION	TAILLE	COULEUR
EP008091BMS		S	BLEU MARINE
EP008091BMM		M	BLEU MARINE
EP008091BML	GILET CHAUD DOS LONG BY BAT GO	L	BLEU MARINE
EP008091BMXL		XL	BLEU MARINE
EP008091BM2XL		2XL	BLEU MARINE
EP008091BM3XL		3XL	BLEU MARINE

GILET BANDES RETRO CHEF DE MANOEUVRE DOS VERT

PORTWEST LTD



GILET BANDE RETRO VERT L/XL Maille 100% polyester - Fermeture par bande rétro horizontale - avec marquage dans le dos "Chef de Manœuvre"

RÉF. ART.	DESCRIPTION	TAILLE	COULEUR
EP009147VEL/XL	L/XL	L/XL	VERT

GILET CHAUD HV MANCHES POLYESTER AMOVIBLES ORANGE

COVERGUARD



Matière extérieure : polyester Oxford enduit PU imperméable fluorescent (70 % polyester / 30 % polyuréthane) Doublure polaire noire 100 % polyester 280 g/m². Bandes rétro réfléchissantes Scotchlite 3M (2 ceintures, 2 bretelles dos et devant) Col droit polaire noire Fermeture à glissière jusqu'en haut du col Manches amovibles en polaire noire 100 % polyester 340 g/m². Dos : protège-reins. Serrage bas devant élastique. 2 poches bas repose-mains. 1 poche téléphone

RÉF. ART.	TAILLE	COULEUR
EP008102ORS	S	ORANGE
EP008102ORM	M	ORANGE
EP008102ORL	L	ORANGE
EP008102ORXL	XL	ORANGE
EP008102OR2XL	XXL	ORANGE
EP008102OR3XL	3XL	ORANGE

GILET CHAUD HV BYES MANCHES POLYESTER AMOVIBLES ORANGE

COVERGUARD



Matière extérieure : polyester Oxford enduit PU imperméable fluorescent (70 % polyester / 30 % polyuréthane) Doublure polaire noire 100 % polyester 280 g/m². Bandes rétro réfléchissantes Scotchlite 3M (2 ceintures, 2 bretelles dos et devant) Col droit polaire noire Fermeture à glissière jusqu'en haut du col Manches amovibles en polaire noire 100 % polyester 340 g/m². Dos : protège-reins. Serrage bas devant élastique. 2 poches bas repose-mains. 1 poche téléphone

RÉF. ART.	TAILLE
EP104702ORS	S
EP104702ORM	M
EP104702ORL	L
EP104702ORXL	XL
EP104702OR2XL	XXL
EP104702ORS3XL	XXXL

GILET CHAUD HV AXIONE MANCHES POLYESTER AMOVIBLES ORANGE

COVERGUARD



RÉF. ART.	TAILLE
EP020786ORS	S
EP020786ORM	M
EP020786ORL	L
EP020786ORXL	XL
EP020786OR2XL	2XL
EP020786OR3XL	3XL

photos non contractuelles

GILET CHAUD HV BZ MANCHES POLYESTER AMOVIBLES ORANGE



RÉF. ART.	TAILLE	COULEUR
EP018159ORS	S	Orange
EP018159ORM	M	Orange
EP018159ORL	L	Orange
EP018159OR2XL	2XL	Orange
EP018159ORXL	XL	Orange

GILET CHAUD HV HRE MANCHES POLYESTER AMOVIBLES ORANGE

COVERGUARD



Matière extérieure : 300 D polyester Oxford enduit PU imperméable fluorescent couleur sombre : 300 D polyester Oxford enduit PU imperméable. Coutures étanchées. Matelassage : 100% polyester Bandes rétro réfléchissantes (2 ceintures, épaules) Col droit intérieure polaire noire. Manches amovibles en polyester noire. Dos : protège-reins Serrage bas devant élastique Poches extérieurs : 2 poches bas repose-mains fermeture par bandes agrippantes 1 poche téléphone 1 porte stylo 1 poche poitrine vertical

RÉF. ART.	TAILLE	COULEUR
EP018147ORS	S	ORANGE/MARINE
EP018147ORM	M	ORANGE/MARINE
EP018147ORL	L	ORANGE/MARINE
EP018147OR2XL	2XL	ORANGE/MARINE
EP018147ORXL	XL	ORANGE/MARINE

GILET CHAUD HV MANCHES POLYESTER AMOVIBLES ORANGE

COVERGUARD



Matière extérieure : polyester Oxford enduit PU imperméable fluorescent (70 % polyester / 30 % polyuréthane) Doublure polaire noire 100 % polyester 280 g/m². Bandes rétro réfléchissantes Scotchlite 3M (2 ceintures, 2 bretelles dos et devant) Col droit polaire noire Fermeture à glissière jusqu'en haut du col Manches amovibles en polaire noire 100 % polyester 340 g/m². Dos : protège-reins. Serrage bas devant élastique. 2 poches bas repose-mains. 1 poche téléphone

RÉF. ART.	DESCRIPTION	TAILLE	COULEUR
EP101199ORS		S	ORANGE
EP101199ORM		M	ORANGE
EP101199ORL	GILET CHAUD HV BY BAT GO MANCHES	L	ORANGE
EP101199ORXL	POLYESTER AMOVIBLES	XL	ORANGE
EP101199OR2XL		2XL	ORANGE
EP101199OR3XL		3XL	ORANGE

GILET CHAUD MARINE MANCHE AMOVIBLE

COVERGUARD



Matière extérieure : 35 % coton, 65 % polyester Matière intérieure : 100 % polyamide Isolation : 100% polyester 180 g/m² légère Fermeture à glissière en plastique avec curseur en métal Manches amovibles Bas élastique 1 poche haut, portable 1 poche haut, 1 stylo 2 poches bas, transversales 1 poche intérieur, portable 1 poche intérieur, portefeuille

RÉF. ART.	TAILLE	COULEUR
EP008092BMM	M	BLEU
EP008092BML	L	BLEU

photos non contractuelles

»		
RÉFÉRENCE ARTICLE	TAILLE	COULEUR
EP008092BMXL	XL	BLEU
EP008092BM2XL	XXL	BLEU

GILET CHAUD REVERSIBLE BREZILLON

PORTWEST

Tissu extérieur : Polaire 100 % polyester, finition anti boulochage 300gr. Tissu de Doublure : Corps : 100 % polyester filet 60 gr. Manches : 100 % polyester tafferfas 60 gr,

RÉF. ART.	DESCRIPTION	TAILLE	COULEUR
EP008696ORS		S	ORANGE
EP008696ORM		M	ORANGE
EP008696ORL		L	ORANGE
EP008696ORXL	GILET CHAUD HV REVERSIBLE BREZILLON	XL	ORANGE
EP008696OR2XL		2XL	ORANGE
EP008696OR3XL		3XL	ORANGE
EP008696OR4XL		4XL	ORANGE

GILET FLUO CLASSE 2



Gilet haute visibilité 100 % polyester double bande rétro réfléchissantes horizontales. 2 bandes rétro réfléchissantes bretelles. Fermeture par double velcro.

RÉF. ART.	TAILLE	COULEUR
EP008100JAS/M	S/M	JAUNE
EP008100JAL/XL	L/XL	JAUNE
EP008100JA23XL	XXL/XXXL	JAUNE
EP008100ORS/M	S/M	ORANGE
EP008100ORL/XL	L/XL	ORANGE
EP008100OR23XL	XXL/XXXL	ORANGE

GILET FLUO HV LINKCITY DEVANT CŒUR ET DOS JAUNE



RÉF. ART.	TAILLE	COULEUR
EP010159JAS/M	S/M	JAUNE
EP010159JAL/XL	L/XL	JAUNE
EP010159JA23XL	XXL/XXXL	JAUNE

GILET FLUO HV LOGO HORIZON COTE COEUR JAUNE

T 2 S



Gilet fluo HV logo HORIZON cote coeur jaune

RÉF. ART.	TAILLE	COULEUR
EP017822JAS/M	S-M	Jaune/Marine
EP017822JAL/XL	L-XL	Jaune/Marine
EP017822JA23XL	2-3XL	Jaune/Marine

GILET FLUO HV RESISTANT A LA FLAMME

PORTWEST LTD

RÉF. ART.	TAILLE	COULEUR
EP018661JAS/M	S/M	JAUNE
EP018661JAL/XL	L/XL	JAUNE
EP018661JA23XL	2XL/3XL	JAUNE
EP018661ORS/M	S/M	ORANGE
EP018661ORL/XL	L/XL	ORANGE
EP018661OR23XL	XXL/XXXL	ORANGE

photos non contractuelles

GILET FLUO HV SEMI-GRILLAGE AVEC PORTE BADGE

PORTWEST LTD



100 % POLYESTER - FERMETURE PAR VELCRO AJUSTABLE - PORTE BADGE - PARTIE GRILLAGEE SUR LE HAUT DU GILET POUR LES CLIMATS CHAUDS - EN471 CLASSE 1:2

RÉF. ART.	TAILLE	COULEUR
EP010559ORS/M	S/M	ORANGE
EP010559ORL/XL	L/XL	ORANGE
EP010559OR23XL	XXL/XXXL	ORANGE
EP010559OR45XL	XXXX/XXXXXL	ORANGE

GILET FLUO À LEDS

PROLUTECH



RÉF. ART.	DESCRIPTION	TAILLE	COULEUR
EP018490JAL		L	JAUNE
EP018490JAXL		XL	JAUNE
EP018490JA2XL	GILET FLUO JAUNE À LEDS	2XL	JAUNE
EP018490JA3XL		3XL	JAUNE
EP018490ORL		L	ORANGE
EP018490ORXL		XL	ORANGE
EP018490OR2XL	GILET FLUO ORANGE À LEDS	2XL	ORANGE
EP018490OR3XL		3XL	ORANGE

GILET FLUO ORANGE CLASSE 2 LOGO BYES



RÉF. ART.	DESCRIPTION	TAILLE	COULEUR
EP008096ORS/M		S/M	ORANGE
EP008096ORL/XL		L/XL	ORANGE
EP008096OR23XL	GILET FLUO ORANGE CLASSE 2 LOGO BYES	XXL/XXXL	ORANGE

GILET FLUO ORANGE HV LEGER POUR ÉTÉ

GILET FLUO ORANGE HV LEGER POUR ÉTÉ TAILLE UNIQUE - 100% POLYESTER - ATTACHES VELCRO SUR CHAQUE CÔTÉ - (FABRICATION SPÉCIALE)



RÉF. ART.	TAILLE	COULEUR
EP009636	TAILLE UNIQUE	ORANGE

photos non contractuelles

GILET FLUO JAUNE HV LEGER POUR ÉTÉ

RÉF. ART.	TAILLE	COULEUR
EP010567	TAILLE UNIQUE	JAUNE

GILET HV ORANGE MANCHES POLAIRE AMOVIBLES

COVERGUARD



Matière extérieure : polyester Oxford enduit PU imperméable fluorescent (70 % polyester / 30 % polyuréthane) Doublure polaire noire 100 % polyester 280 g/m². Bandes rétro réfléchissantes Scotchlite 3M (2 ceintures, 2 bretelles dos et devant) Col droit polaire noire Fermeture à glissière jusqu'en haut du col Manches amovibles en polaire noire 100 % polyester 340 g/m². Dos : protège-reins. Serrage bas devant élastique. 2 poches bas repose-mains. 1 poche téléphone

RÉF. ART.	TAILLE	COULEUR
EP008101ORL	L	ORANGE
EP008101ORM	M	ORANGE
EP008101ORXL	XL	ORANGE
EP008101OR2XL	XXL	ORANGE

GILET HV ORANGE MANCHES POLAIRE AMOVIBLES BYES

COVERGUARD



Matière extérieure : polyester Oxford enduit PU imperméable fluorescent (70 % polyester / 30 % polyuréthane) Doublure polaire noire 100 % polyester 280 g/m². Bandes rétro réfléchissantes Scotchlite 3M (2 ceintures, 2 bretelles dos et devant) Col droit polaire noire Fermeture à glissière jusqu'en haut du col Manches amovibles en polaire noire 100 % polyester 340 g/m². Dos : protège-reins. Serrage bas devant élastique. 2 poches bas repose-mains. 1 poche téléphone

RÉF. ART.	TAILLE	COULEUR
EP008103ORM	M	ORANGE
EP008103ORL	L	ORANGE
EP008103ORXL	XL	ORANGE
EP008103OR2XL	XXL	ORANGE

photos non contractuelles

GILET HV MULTIPOCHES

PORTWEST LTD



Gilet haute visibilité 100 % polyeter double bande rétroréfléchissantes horizontales. 2 bandes rétroréfléchissantes bretelles. 2 poches plaquées avec rabat, une poche téléphone, 1 anneau.

RÉF. ART.	TAILLE	COULEUR
EP008105JAS	S	JAUNE
EP008105JAM	M	JAUNE
EP008105JAL	L	JAUNE
EP008105JAXL	XL	JAUNE
EP008105JA2XL	XXL	JAUNE
EP008105JA3XL	XXXL	JAUNE
EP008105ORS	S	ORANGE
EP008105ORM	M	ORANGE
EP008105ORL	L	ORANGE
EP008105ORXL	XL	ORANGE
EP008105OR2XL	XXL	ORANGE
EP008105OR3XL	XXXL	ORANGE

GILET MULTIPOCHES HV MARQUAGE COEUR AXIONE ORANGE

T 2 S



RÉF. ART.	TAILLE
EP020281ORS	S
EP020281ORM	M
EP020281ORL	L
EP020281ORXL	XL
EP020281OR2XL	2XL
EP020281OR3XL	3XL

GILET MULTIPOCHES HV MARQUAGE COEUR BYES ORANGE

T 2 S



RÉF. ART.	TAILLE
EP017199ORS	S
EP017199ORM	M
EP017199ORL	L
EP017199ORXL	XL
EP017199OR2XL	2XL
EP017199OR3XL	3XL

GILET MULTIPOCHES HV MARQUAGE COEUR HORIZON JAUNE

T 2 S



RÉF. ART.	TAILLE	COULEUR
EP017890JAM	M	Jaune
EP017890JAL	L	Jaune
EP017890JAXL	XL	Jaune
EP017890JA2XL	2XL	Jaune
EP017890JA3XL	3XL	Jaune

photos non contractuelles

GILET WIZOM REHABILITATION MULTIPOCHES MAILLE MADRID

TAILLE UNIQUE L



RÉF. ART.

EP018733ORL

GILET SAFARI LED CONNECTE SANS BATTERIE

T 2 S



RÉF. ART.	TAILLE	COULEUR
EP018494ORS	S	ORANGE
EP018494ORM	M	ORANGE
EP018494ORL	L	ORANGE
EP018494ORXL	XL	ORANGE
EP018494OR2XL	2XL	ORANGE
EP018494OR3XL	3XL	ORANGE
EP018494JAS	S	JAUNE
EP018494JAM	M	JAUNE
EP018494JAL	L	JAUNE
EP018494JAXL	XL	JAUNE
EP018494JA2XL	2XL	JAUNE
EP018494JA3XL	3XL	JAUNE

SOLUTION CONNECTEE DETECTION ENGIN-PIETON



RÉF. ART.

DESCRIPTION

EP1---

LA SOLUTION CONNECTÉE À LA SÉCURITÉ DES COMPAGNONS
POSSIBILITÉ DE LOUER LES ACCESSOIRES POUR NOTRE SOLUTION
CONNECTÉE (BATTERIE, STATION DE TEST, KIT BALISE FILAIRE,
STATION DE RECHARGE), RAPPROCHEZ-VOUS DE VOTRE
INTERLOCUTEUR DISTRIPUS

AUTRES VETEMENTS LOGOTES



RÉF. ART.

DESCRIPTION

TAILLE

EP2---

Si vous souhaitez un vêtement logoté, contactez votre
interlocuteur Distrimo

L

photos non contractuelles

GILET LYNE PRO FEMME POUR ACTIVITES MANUELLES GRIS Pour rappel, produit spécifique qui nécessite un avis et un accompagnement de la filière prévention

PERCKO



we life

Composition : 78% POLYAMIDE - 22% ELASTANE - Objectif : Diminuer les maux de dos. En rederessant votre dos régulièrement, les muscles sont engagés et dynamisés, ce qui renforce les muscles du dos. Rééduquer votre dos. Effet proprioceptif. Contre indication : Utilisateurs ayant les pathologies : Maladies inflammatoires en phase aiguë. Pathologies, entraînant un affaiblissement des articulations, des muscles, des tendons, etc. Maladie inflammatoire aiguë ou enorse de l'épaule. Grossesse. Fracture

RÉF. ART.	DESCRIPTION	TAILLE
EP105764GRXS		XS
EP105764GRS		S
EP105764GRM	GILET LYNE PRO FEMME POUR LES ACTIVITES MANUELLES GRIS	M
EP105764GRL		L
EP105764GRXL		XL
EP105764GR2XL		XXL

GILET LYNE PRO HOMME POUR ACTIVITES MANUELLES GRIS Pour rappel, produit spécifique qui nécessite un avis et un accompagnement de la filière prévention

PERCKO



we life

Composition : 78% POLYAMIDE - 22% ELASTANE - Objectif : Diminuer les maux de dos. En rederessant votre dos régulièrement, les muscles sont engagés et dynamisés, ce qui renforce les muscles du dos. Rééduquer votre dos. Effet proprioceptif. Contre indication : Utilisateurs ayant les pathologies : Maladies inflammatoires en phase aiguë. Pathologies, entraînant un affaiblissement des articulations, des muscles, des tendons, etc. Maladie inflammatoire aiguë ou enorse de l'épaule. Grossesse. Fracture

RÉF. ART.	DESCRIPTION	TAILLE
EP105763GRXS		XS
EP105763GRS		S
EP105763GRM		M
EP105763GRL	GILET LYNE PRO HOMME POUR LES ACTIVITES MANUELLES GRIS	L
EP105763GRXL		XL
EP105763GR2XL		XXL
EP105763GR3XL		XXXL

photos non contractuelles

TEE SHIRT LYNE UP PERCKO FEMME POUR LE QUOTIDIEN NOIR Pour rappel, produit spécifique qui nécessite un avis et un accompagnement de la filière prévention

PERCKO

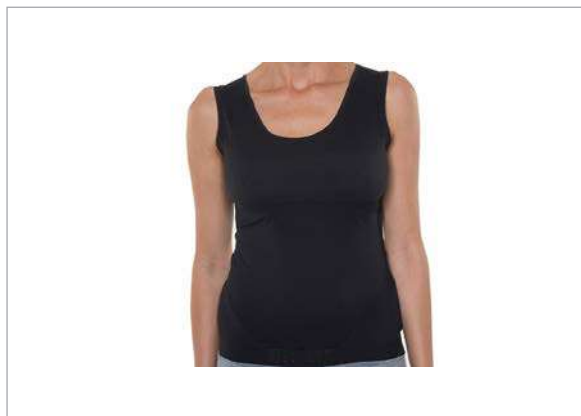

Composition : 78% POLYAMIDE - 22% ELASTANE - Objectif : Diminuer les maux de dos. En rederessant votre dos régulièrement, les muscles sont engagés et dynamisés, ce qui renforce les muscles du dos. Rééduquer votre dos. Effet proprioceptif. Contre indication : Utilisateurs ayant les pathologies : Maladies inflammatoires en phase aiguë. Pathologies, entraînant un affaiblissement des articulations, des muscles, des tendons, etc. Maladie inflammatoire aiguë ou enorse de l'épaule. Grossesse. Fracture

RÉF. ART.	DESCRIPTION	TAILLE
EP0105762NOT1		T1
EP0105762NOT2		T2
EP0105762NOT3		T3
EP0105762NOT4	TEE SHIRT LYNE UP PERCKO FEMME POUR LE QUOTIDIEN NOIR	T4
EP0105762NOT5		T5
EP0105762NOT6		T6
EP0105762NOT7		T7

TEE SHIRT LYNE UP PERCKO FEMME POUR LE QUOTIDIEN NUDE Pour rappel, produit spécifique qui nécessite un avis et un accompagnement de la filière prévention

PERCKO



Composition : 78% POLYAMIDE - 22% ELASTANE - Objectif : Diminuer les maux de dos. En rederessant votre dos régulièrement, les muscles sont engagés et dynamisés, ce qui renforce les muscles du dos. Rééduquer votre dos. Effet proprioceptif. Contre indication : Utilisateurs ayant les pathologies : Maladies inflammatoires en phase aiguë. Pathologies, entraînant un affaiblissement des articulations, des muscles, des tendons, etc. Maladie inflammatoire aiguë ou enorse de l'épaule. Grossesse. Fracture

RÉF. ART.	DESCRIPTION	TAILLE
EP0105762NUT1		T1
EP0105762NUT2		T2
EP0105762NUT3		T3
EP0105762NUT4	TEE SHIRT LYNE UP PERCKO FEMME POUR LE QUOTIDIEN NUDE	T4
EP0105762NUT5		T5
EP0105762NUT6		T6
EP0105762NUT7		T7

photos non contractuelles

TEE SHIRT LYNE UP PERCKO HOMME POUR LE QUOTIDIEN NOIR Pour rappel, produit spécifique qui nécessite un avis et un accompagnement de la filière prévention

PERCKO



Composition : 78% POLYAMIDE - 22% ELASTANE - Objectif : Diminuer les maux de dos. En rederessant votre dos régulièrement, les muscles sont engagés et dynamisés, ce qui renforce les muscles du dos. Rééduquer votre dos. Effet proprioceptif. Contre indication : Utilisateurs ayant les pathologies : Maladies inflammatoires en phase aiguë. Pathologies, entraînant un affaiblissement des articulations, des muscles, des tendons, etc. Maladie inflammatoire aiguë ou enorse de l'épaule. Grossesse. Fracture

RÉF. ART.	DESCRIPTION	TAILLE
EP105761NOT1		T1
EP105761NOT2		T2
EP105761NOT3		T3
EP105761NOT4	TEE SHIRT LYNE UP PERCKO HOMME POUR LE QUOTIDIEN NOIR	T4
EP105761NOT5		T5
EP105761NOT6		T6
EP105761NOT7		T7

TEE SHIRT LYNE UP PERCKO HOMME POUR LE QUOTIDIEN NUDE Pour rappel, produit spécifique qui nécessite un avis et un accompagnement de la filière prévention

PERCKO



Composition : 78% POLYAMIDE - 22% ELASTANE - Objectif : Diminuer les maux de dos. En rederessant votre dos régulièrement, les muscles sont engagés et dynamisés, ce qui renforce les muscles du dos. Rééduquer votre dos. Effet proprioceptif. Contre indication : Utilisateurs ayant les pathologies : Maladies inflammatoires en phase aiguë. Pathologies, entraînant un affaiblissement des articulations, des muscles, des tendons, etc. Maladie inflammatoire aiguë ou enorse de l'épaule. Grossesse. Fracture

RÉF. ART.	DESCRIPTION	TAILLE
EP105761NUT1		T1
EP105761NUT2		T2
EP105761NUT3		T3
EP105761NUT4	TEE SHIRT LYNE UP PERCKO HOMME POUR LE QUOTIDIEN NUDE	T4
EP105761NUT5		T5
EP105761NUT6		T6
EP105761NUT7		T7

CONSULTEZ LE GUIDE D'UTILISATION LYNE UP LYNE PRO

BYCN



photos non contractuelles

TEE-SHIRT HV MANCHES COURTES JAKATA ORANGE / MARINE



RÉF. ART.	DESCRIPTION	TAILLE	COULEUR
EP009093OMS	TEE-SHIRT HV ORANGE / MARINE POLY COTON	S	ORANGE/ BLEU
EP009093OMM		M	ORANGE/ BLEU
EP009093OML		L	ORANGE/ BLEU
EP009093OMXL		XL	ORANGE/ BLEU
EP009093OM2XL		XXL	ORANGE/ BLEU
EP009093OM3XL		XXXL	ORANGE/ BLEU

TEE-SHIRT HV BZ MANCHES COURTES JAKARTA ORANGE / MARINE

T 2 S



RÉF. ART.	TAILLE
EP018743OMS	S
EP018743OMM	M
EP018743OML	L
EP018743OMXL	XL
EP018743OM2XL	2XL
EP018743OM3XL	3XL

TEE-SHIRT HV HRE MANCHES COURTES JAKARTA ORANGE / MARINE

T 2 S



RÉF. ART.	TAILLE
EP018744OMS	S
EP018744OMM	M
EP018744OML	L
EP018744OMXL	XL
EP018744OM2XL	2XL
EP018744OM3XL	3XL

TEE-SHIRT HV BY TP MANCHES COURTES JAKARTA ORANGE / MARINE

T 2 S



Coupe cintrée - Protection contre les UV - Manches courtes ourlées - Maille ajourée sous les bras pour une ventilation maximale - Col V avec bande de propreté - Empiècements contrastés sur les épaules et au bas du tee-shirt - Deux bretelles et une ceinture rétroréfléchissantes microbilles segmentées RETHIOTEX® de 6 cm (S, M) ou de 5 cm (L, XL, XXL, XXXL) thermocollées.

RÉF. ART.	DESCRIPTION	TAILLE
EP017181OMS	TEE-SHIRT HV MANCHES COURTES BY TP ORANGE/ MARINE	S
EP017181OMM		M
EP017181OML		L
EP017181OMXL		XL
EP017181OM2XL		XXL
EP017181OM3XL		XXXL

photos non contractuelles

TEE-SHIRT HV AXIONE MANCHES COURTES JAKARTA ORANGE/MARINE

T 2 S



RÉF. ART.	DESCRIPTION	TAILLE
EP020279OMS		S
EP020279OMM		M
EP020279OMXL		XL
EP020279OM2XL	TEE-SHIRT HV POLY COTON AXIONE M. COURTES JAKARTA O/M	2XL
EP020279OM3XL		3XL
EP020279OM4XL		4XL
EP020279OM5XL		5XL

TEE-SHIRT HV BYES MANCHES COURTES JAKARTA BYES ORANGE/MARINE

T 2 S



RÉF. ART.	DESCRIPTION	TAILLE
EP020280OMS		S
EP020280OMM		M
EP020280OML		L
EP020280OMXL	TEE-SHIRT HV POLY COTON BYES M. COURTES JAKARTA O/M	XL
EP020280OM2XL		2XL
EP020280OM3XL		3XL
EP020280OM4XL		4XL
EP020280OM5XL		5XL

TEE-SHIRT HV HORIZON MANCHES COURTES JAKARTA JAUNE/MARINE

T 2 S



tee-shirt HV manches courtes JAKARTA logo HORIZON coeur jaune / marine

RÉF. ART.	TAILLE	COULEUR
EP017820JMS	S	Jaune/Marine
EP017820JMM	M	Jaune/Marine
EP017820JML	L	Jaune/Marine
EP017820JMXL	XL	Jaune/Marine
EP017820JM2XL	2XL	Jaune/Marine
EP017820JM3XL	3XL	Jaune/Marine

photos non contractuelles

TEE-SHIRT HV BY TP RF MANCHES COURTES JAKARTA ORANGE/MARINE



Matière : Maille piquée double face Nittex Duo 53 % coton 47 % polyester 185 gr. Maille ajourée 100 % polyester 115 gr.

RÉF. ART.	DESCRIPTION	TAILLE	COULEUR
EP020277OMS		S	ORANGE/MARINE
EP020277OMM		M	ORANGE/MARINE
EP020277OML		L	ORANGE/MARINE
EP020277OMXL		XL	ORANGE/MARINE
EP020277OM2XL	TEE-SHIRT HV POLY COTON BYTPRF MANCHES COURTES JAKARTA	2XL	ORANGE/MARINE
EP020277OM3XL		3XL	ORANGE/MARINE
EP020277OM4XL		4XL	ORANGE/MARINE
EP020277OM5XL		5XL	ORANGE/MARINE
EP020277OM6XL		6XL	ORANGE/MARINE

TEE-SHIRT HV MANCHES LONGUES JAKARTA ORANGE/MARINE

T 2 S



RÉF. ART.	DESCRIPTION	TAILLE
EP017742OMS		S
EP017742OMM		M
EP017742OML	TEE-SHIRT HV POLY COTON M/LONGUES JAKARTA	L
EP017742OMXL	ORANGE/MARINE	XL
EP017742OM2XL		2XL
EP017742OM3XL		3XL

photos non contractuelles

TEE-SHIRT HV BY TP RF MANCHES LONGUESJAKARTA ORANGE / MARINE



Matière : Maille piquée double face Nittex Duo 53 % coton 47 % polyester 185 gr. Maille ajourée 100 % polyester 115 gr.

RÉF. ART.	DESCRIPTION	TAILLE	COULEUR
EP100079OMS	TEE-SHIRT HV POLY COTON BY TP RF MANCHES LONGUES	S	ORANGE/MARINE
EP100079OMM		M	ORANGE/MARINE
EP100079OML		L	ORANGE/MARINE
EP100079OMXL		XL	ORANGE/MARINE
EP100079OM2XL		2XL	ORANGE/MARINE
EP100079OM3XL		3XL	ORANGE/MARINE
EP100079OM4XL	4XL	ORANGE/MARINE	
EP100079OM5XL	5XL	ORANGE/MARINE	

TEE-SHIRT HV MANCHES LONGUES BALI ORANGE/MARINE

T 2 S



Coupe cintrée. Protection contre les UV. Manches longues ourlées. Maille ajourée sous les bras pour une ventilation maximale. Col V avec bande de propreté. Empiècements contrastés sur les épaules et au bas du tee-shirt. Deux bretelles rétro réfléchissantes microbilles segmentées RETHIOTEX® 26 250-01 de 5 cm thermocollées. Une ceinture rétro réfléchissante microbilles segmentée RETHIOTEX® 26 250-01 de 6 cm (M) ou de 5 cm (S,L,XL,XXL,XXXL) thermocollée. Deux brassards rétro réfléchissants microbilles

RÉF. ART.	DESCRIPTION	TAILLE	COULEUR
EP017840OMS	TEE-SHIRT HV MANCHES LONGUES 100% POLY BALI 9 O/M	S	Orange/Marine
EP017840OMM		M	Orange/Marine
EP017840OML		L	Orange/Marine
EP017840OMXL		XL	Orange/Marine
EP017840OM2XL		2XL	Orange/Marine
EP017840OM3XL		3XL	Orange/Marine

photos non contractuelles

TEE-SHIRT HV BY TP MANCHES LONGUES BALI ORANGE/MARINE

T 2 S



Coupe cintrée. Protection contre les UV. Manches longues ourlées. Maille ajourée sous les bras pour une ventilation maximale. Col V avec bande de propreté. Empiècements contrastés sur les épaules et au bas du tee-shirt. Deux bretelles rétro réfléchissantes microbilles segmentées RETHIOTEX® 26 250-01 de 5 cm thermocollées. Une ceinture rétro réfléchissante microbilles segmentée RETHIOTEX® 26 250-01 de 6 cm (M) ou de 5 cm (S,L,XL,XXL,XXXL) thermocollée. Deux brassards rétro réfléchissants microbilles

RÉF. ART.	DESCRIPTION	TAILLE
EP017182OMS		S
EP017182OMM		M
EP017182OML	TEE-SHIRT HV MANCHES LONGUES BY TP ORANGE/	L
EP017182OMXL	MARINE	XL
EP017182OM2XL		XXL
EP017182OM3XL		XXXL

TEE-SHIRT HV ORANGE CLASSE 2 BYES

PORTWEST LTD



TEE-SHIRT HV ORANGE - Certifié EN471 classe 2. Certifié GO/RT 3279. Bandes rétro réfléchissantes cousues HiVisTex de 5cm (2 bandes poitrine + bretelles). Matière: 100% polyester, 150g, maille nid d'abeille (type maillot de foot). Tailles: L

RÉF. ART.	DESCRIPTION	TAILLE	COULEUR
EP008160ORS		S	ORANGE
EP008160ORM	TEE-SHIRT HV ORANGE CLASSE 2 -	M	ORANGE
EP008160ORL	LOGO BYES	L	ORANGE
EP008160ORXL		XL	ORANGE

»

RÉFÉRENCE ARTICLE	DESCRIPTION	TAILLE	COULEUR
EP008160OR2XL	TEE-SHIRT HV ORANGE CLASSE 2 -	XXL	ORANGE
EP008160OR3XL	LOGO BYES	XXXL	ORANGE

TEE-SHIRT HV ORANGE CLASSE 2

PORTWEST LTD



TEE-SHIRT HV ORANGE - Certifié EN471 classe 2. Certifié GO/RT 3279. Bandes rétro réfléchissantes cousues HiVisTex de 5cm (2 bandes poitrine + bretelles). Matière: 100% polyester, 150g, maille nid d'abeille (type maillot de foot). Tailles: L

RÉF. ART.	TAILLE	COULEUR
EP008163ORS	S	ORANGE
EP008163ORM	M	ORANGE
EP008163ORL	L	ORANGE
EP008163ORXL	XL	ORANGE
EP008163OR2XL	XXL	ORANGE
EP008163OR3XL	XXXL	ORANGE

TEE-SHIRT MANCHES LONGUES NOIR AXIONE CŒUR



RÉF. ART.	DESCRIPTION	TAILLE	COULEUR
EP010624NOS		S	NOIR
EP010624NOM		M	NOIR
EP010624NOL	TEE-SHIRT LOGO AXIONE CŒUR	L	NOIR
EP010624NOXL	MANCHES LONGUES NOIR	XL	NOIR
EP010624NO2XL		XXL	NOIR
EP010624NO3XL		XXXL	NOIR

photos non contractuelles

POLO HV LERBY PROTECTION ARC ORANGE

SIOEN



we
life

RÉF. ART.	TAILLE
EP020780ORS	S
EP020780ORM	M
EP020780ORL	L
EP020780ORXL	XL
EP020780OR2XL	2XL
EP020780OR3XL	3XL

POLO LOGO AXIONE CŒUR MANCHES LONGUES NOIR



RÉF. ART.	TAILLE	COULEUR
EP010625NOS	S	NOIR
EP010625NOM	M	NOIR
EP010625NOL	L	NOIR
EP010625NOXL	XL	NOIR
EP010625NO2XL	XXL	NOIR
EP010625NO3XL	XXXL	NOIR

POLO HV ORANGE CLASSE 2

PORTWEST LTD



POLO HV ORANGE - Col 3 boutons gris avec liseré orange. Bandes rétro réfléchissantes cousues HiVisTex de 5cm (2 bandes poitrine + bretelles). Matière : 100% polyester, 175g, maille nid d'abeille (type maillot de foot). Certifié EN471 classe 2. Certifié GO/RT 3279. Tailles: L

RÉF. ART.	TAILLE	COULEUR
EP008139ORS	S	ORANGE
EP008139ORM	M	ORANGE
EP008139ORL	L	ORANGE
EP008139ORXL	XL	ORANGE
EP008139OR2XL	XXL	ORANGE
EP008139OR3XL	XXXL	ORANGE

photos non contractuelles

PULL POLAIRE BLEU MARINE

COVERGUARD



RÉF. ART.	TAILLE	COULEUR
EP008146BMM	M	BLEU
EP008146BML	L	BLEU
EP008146BMXL	XL	BLEU
EP008146BM2XL	XXL	BLEU

PULL POLAIRE NOIR

COVERGUARD



RÉF. ART.	TAILLE	COULEUR
EP008146NOM	M	NOIR
EP008146NOL	L	NOIR
EP008146NOXL	XL	NOIR
EP008146NO2XL	XXL	NOIR

PULL POLAIRE BLEU MARINE BY BAT GO

COVERGUARD



Matière extérieur : Polaire 100% polyester 340 gr, anti bou-lochage. Fermeture par bande agrippante et pressions. Manches : terminées par poignets droits ourlés élastiques. 2 poches latérales.

RÉF. ART.	DESCRIPTION	TAILLE	COULEUR
EP008145BMS		S	BLEU MARINE
EP008145BMM		M	BLEU MARINE
EP008145BML	PULL POLAIRE BY BAT GO	L	BLEU MARINE
EP008145BMXL		XL	BLEU MARINE
EP008145BM2XL		2XL	BLEU MARINE

PULL POLAIRE NOIR BY BAT GO

COVERGUARD



Matière extérieur : Polaire 100% polyester 340 gr, anti bou-lochage. Fermeture par bande agrippante et pressions. Manches : terminées par poignets droits ourlés élastiques. 2 poches latérales.

RÉF. ART.	DESCRIPTION	TAILLE	COULEUR
EP008145NOS		S	NOIR
EP008145NOM		M	NOIR
EP008145NOL	PULL POLAIRE BY BAT GO	L	NOIR
EP008145NOXL		XL	NOIR
EP008145NO2XL		2XL	NOIR

photos non contractuelles

SWEAT SHIRT HV BY TP ORANGE

PORTWEST LTD



300gr - 65% polyester / 35% coton brossé pour plus de chaleur
- ceintures et poignets élastiqués - tissu assurant respirabilité, souplesse, solidité et durabilité extérieure - logo BY travaux Publics transfert cœur

RÉF. ART.	TAILLE	COULEUR
EP020189ORS	S	ORANGE
EP020189ORM	M	ORANGE
EP020189ORL	L	ORANGE
EP020189ORXL	XL	ORANGE
EP020189OR2XL	2XL	ORANGE
EP020189OR3XL	3XL	ORANGE
EP020189OR4XL	4XL	ORANGE
EP020189OR5XL	5XL	ORANGE

AUTRES VETEMENTS LOGOTES

RÉF. ART.	DESCRIPTION
EP2---	Si vous souhaitez un vêtement logoté, contactez votre interlocuteur Distrimo

POLAIRE ZIPPE 300GRS BY BAT GO BICOLORE HV

PORTWEST



Tissu extérieur : Industrie 300D : Polyester, tissage Oxford 300D avec finition résistance aux taches, enduits PU 190 gr. Tissu de Doublure : 65 % polyester 35 % coton 260 gr. Tissu de remplissage : 100 % polyester 200 gr.

RÉF. ART.	TAILLE	COULEUR
EP020628OMXS	XS	ORANGE/MARINE
EP020628OMS	S	ORANGE/MARINE
EP020628OMM	M	ORANGE/MARINE
EP020628OML	L	ORANGE/MARINE
EP020628OMXL	XL	ORANGE/MARINE
EP020628OM2XL	2XL	ORANGE/MARINE
EP020628OM3XL	3XL	ORANGE/MARINE
EP020628OM4XL	4XL	ORANGE/MARINE

photos non contractuelles

VESTE ANTI-COUPURE EN381-11CLASSE 1

SIOEN

we
life

RÉF. ART.	DESCRIPTION	TAILLE
EP018206OVL	- 20M/S ORANGE / VERT	L
EP018206OVXL		XL

VESTE DE PLUIE ORANGE FLUO + BANDE

PORTWEST LTD



100% Polyester enduit PVC 170g Doublure: 100% Polyester filet 60g - Imperméable haute visibilité de qualité. Protege de la pluie et du vent Conçue pour que l'utilisateur soit visible et en sécurité pendant les intempéries.

RÉF. ART.	TAILLE	COULEUR
EP008166ORS	S	ORANGE
EP008166ORM	M	ORANGE
EP008166ORL	L	ORANGE
EP008166ORXL	XL	ORANGE
EP008166OR2XL	XXL	ORANGE
EP008166OR3XL	XXXL	ORANGE

VESTE DE PLUIE ORANGE FLUO + BANDES RETRO LOGO BYES

PORTWEST LTD



100% Polyester enduit PVC 170g Doublure: 100% Polyester filet 60g - Imperméable haute visibilité de qualité. Protege de la pluie et du vent Conçue pour que l'utilisateur soit visible et en sécurité pendant les intempéries.

RÉF. ART.	TAILLE	COULEUR
EP008167ORXL	S	ORANGE
EP008167ORM	M	ORANGE
EP008167ORL	L	ORANGE
EP008167OR2XL	XXL	ORANGE
EP008167OR3XL	XXXL	ORANGE

VESTE DE SOUDAGE DEVANT CUIR DOS PROBAN

SINGER
safetywe
life

RÉF. ART.	TAILLE
EP004591M	M
EP004591L	L
EP004591XL	XL

photos non contractuelles

VESTE IMPERMEABLE LONGUE + CAPUCHE

COVERGUARD



ENDUIT PVC COUSU SOUDE

RÉF. ART.	TAILLE	COULEUR
EP008168VEM	M	VERT
EP008168VEL	L	VERT
EP008168VEXL	XL	VERT
EP008168VE2XL	XXL	VERT

VESTE MOLLETON GRIS CHINE MIKAN 300 GR BRODE COEUR AXIONE

COVERGUARD



Logo Blanc - Molleton : 80 coton, 20% polyester - Bord-côtes : 100% polyester - Ripstop (5mm) : 100% polyester enduit PVC. 300g/m² - Col montant - Zip central - 1 poche poitrine plaquée zippée en Ripstop - 2 poches basses verticales - 2 poches basses inférieures - Poignets et bas de la veste en bord-côte - Empiècements Ripstop anti-abrasion aux coudes

RÉF. ART.	TAILLE
EP104711GRS	S
EP104711GRM	M
EP104711GRL	L
EP104711GRXL	XL
EP104711GR2XL	2XL
EP104711GR3XL	3XL

VESTE POLAIRE LOGO AXIONE COEUR MANCHES LONGUES



RÉF. ART.	DESCRIPTION	TAILLE	COULEUR
EP010626NOS		S	NOIR
EP010626NOM		M	NOIR
EP010626NOL		L	NOIR
EP010626NOXL	NOIR	XL	NOIR
EP010626NO2XL		XXL	NOIR
EP010626NO3XL		XXXL	NOIR
EP010626NO4XL		XXXXL	NOIR

VESTE SOFTSHELL PLAYFORD AXIONE PROTECTION ARC

SIOEN



we life

RÉF. ART.	DESCRIPTION	TAILLE
EP020778OMS		S
EP020778OMM		M
EP020778OML		L
EP020778OMXL	O/M	XL
EP020778OM2XL		2XL
EP020778OM3XL		3XL

photos non contractuelles

VESTE SOFTSHELL PLAYFORD BYES PROTECTION ARC

SIOEN



RÉF. ART.	DESCRIPTION	TAILLE
EP018732OMS		S
EP018732OMM		M
EP018732OML		L
EP018732OMXL	O/M	XL
EP018732OM2XL		2XL
EP018732OM3XL		3XL

SUR COMMANDE = soumis à des délais supérieurs à ceux habituels

SUR COMMANDE = SOUMIS À DES DÉLAIS SUPÉRIEURS À CEUX HABITUELS



RÉF. ART.

SUR COMMANDE

PARKA ORRINGTON HV ETANCHE PROTECTION ARC

SIOEN



RÉF. ART.	TAILLE	COULEUR
EP020785ORS	S	ORANGE
EP020785ORM	M	ORANGE
EP020785ORL	L	ORANGE
EP020785ORXL	XL	ORANGE
EP020785OR2XL	2XL	ORANGE
EP020785OR3XL	3XL	ORANGE

photos non contractuelles

PARKA 4 EN 1 HOMME HV (Disponible jusqu'à 6XL sur commande)



DAKOTA Parka 100% polyester oxford 300D enduit PU respirant 190g avec gilet de froid amovible et manches zippées amovibles Coutures étanchées Fermeture à glissière double curseur sous rabat à velcro 1 poche zippée cachée sous rabat 2 poches basses à rabat 2 poches intérieures velcro 1 poche téléphone intérieure avec rabat velcro Bas de manches réglables avec patte de serrage velcro. Gilet amovible doublure polyester mesh zippé dans la parka Manches zippées amovibles Fermeture centrale à glissière

RÉF. ART.	TAILLE	COULEUR
EP008126OMS	S	ORANGE/BLEU
EP008126OMM	M	ORANGE/BLEU
EP008126OML	L	ORANGE/BLEU
EP008126OMXL	XL	ORANGE/BLEU
EP008126OM2XL	XXL	ORANGE/BLEU
EP008126OM3XL	XXXL	ORANGE/BLEU
EP008126JMS	S	JAUNE/BLEU
EP008126JMM	M	JAUNE/BLEU
EP008126JML	L	JAUNE/BLEU
EP008126JMXL	XL	JAUNE/BLEU
EP008126JM2XL	XXL	JAUNE/BLEU
EP008126JM3XL	XXXL	JAUNE/BLEU
EP008128OMXS	XS	ORANGE/BLEU
EP008128OMS	S	ORANGE/BLEU
EP008128OMM	M	ORANGE/BLEU
EP008128OML	L	ORANGE/BLEU
EP008128JMXS	XS	JAUNE/BLEU
EP008128JMS	S	JAUNE/BLEU
EP008128JMM	M	JAUNE/BLEU
EP008128JML	L	JAUNE/BLEU

ECUSSON SST POUR PARKA 4 EN 1 T2S

T 2 S



RÉF. ART.	DESCRIPTION
EP018299	ECUSSON SST Ø 80MM AUTO AGRIPPANT

PARKA 4 EN 1 HV BY TP ORANGE/MARINE



RÉF. ART.	DESCRIPTION	TAILLE	COULEUR
EP008121OMS	PARKA 4 EN 1 HV BY TP RESPIRANT ORANGE/MARINE	S	ORANGE/BLEU
EP008121OMM		M	ORANGE/BLEU
EP008121OML		L	ORANGE/BLEU
EP008121OMXL		XL	ORANGE/BLEU
EP008121OM2XL		XXL	ORANGE/BLEU
EP008121OM3XL		XXXL	ORANGE/BLEU

photos non contractuelles

PARKA 4 EN 1 HV BZ ORANGE / MARINE

T 2 S



RÉF. ART.	DESCRIPTION	TAILLE	COULEUR
EP018157OMS	PARKA 4 EN 1 HV BZ RESPIRANT ORANGE / MARINE	S	ORANGE/ MARINE
EP018157OMM		M	ORANGE/ MARINE
EP018157OML		L	ORANGE/ MARINE
EP018157OMXL		XL	ORANGE/ MARINE
EP018157OM2XL		XXL	ORANGE/ MARINE
EP018157OM3XL		XXXL	ORANGE/ MARINE

PARKA 4 EN 1 HV FEMME HRE ORANGE / MARINE

T 2 S



RÉF. ART.	DESCRIPTION	TAILLE	COULEUR
EP018146OMXS	PARKA 4 EN 1 HV FEMME HRE RESPIRANT ORANGE / MARINE	XS	ORANGE/ MARINE
EP018146OMS		S	ORANGE/ MARINE
EP018146OMM		M	ORANGE/ MARINE
EP018146OML		L	ORANGE/ MARINE

PARKA 4 EN 1 HV FEMME BZ ORANGE / MARINE

RÉF. ART.	DESCRIPTION	TAILLE	COULEUR
EP018158ORXS	PARKA 4 EN 1 HV FEMME BZ RESPIRANT ORANGE / MARINE	XS	ORANGE/ MARINE
EP018158ORS		S	ORANGE/ MARINE
EP018158ORM		M	ORANGE/ MARINE
EP018158ORL		L	ORANGE/ MARINE

photos non contractuelles

PARKA 4 EN 1 HV HRE ORANGE / MARINE

T 2 S



Parka 100% polyester oxford 300D enduit PU respirant 190g avec gilet de froid amovible et manches zippées amovibles Coutures étanchées Fermeture à glissière double curseur sous rabat à velcro 1 poche zippée cachée sous rabat 2 poches basses à rabat 2 poches intérieures velcro 1 poche téléphone intérieure avec rabat velcro Bas de manches réglables avec patte de serrage velcro. Gilet amovible doublure polyester mesh zippé dans la parka Manches zippées amovibles Fermeture centrale à glissière Col d

RÉF. ART.	DESCRIPTION	TAILLE	COULEUR
EP018145OMS	PARKA 4 EN 1 HV HRE RESPIRANT ORANGE / MARINE	S	ORANGE/MARINE
EP018145OMM		M	ORANGE/MARINE
EP018145OML		L	ORANGE/MARINE
EP018145OMXL		XL	ORANGE/MARINE
EP018145OM2XL		2XL	ORANGE/MARINE
EP018145OM3XL		3XL	ORANGE/MARINE

PARKA 4 EN 1 HV AXIONE ORANGE/ MARINE



RÉF. ART.	DESCRIPTION	TAILLE	COULEUR
EP010656OMS	PARKA 4 EN 1 HV RESPIRANT AXIONE ORANGE/MARINE	S	ORANGE/ BLEU
EP010656OMM		M	ORANGE/ BLEU
EP010656OML		L	ORANGE/ BLEU
EP010656OMXL		XL	ORANGE/ BLEU
EP010656OM2XL		XXL	ORANGE/ BLEU
EP010656OM3XL		XXXL	ORANGE/ BLEU

photos non contractuelles

PARKA 4 EN 1 BYES ORANGE/MARINE



PARKA 4 en 1 RESPIRANT Parka avec gilet de froid amovible et manches zippées amovibles. Coutures étanchées - Fermeture à glissière double curseur sous rabat à velcro. 1 poche zippée cachée sous rabat (poche napoléon) - 2 poches basses à rabat. Repose mains - 2 poches intérieures velcro - 1 poche téléphone intérieure avec rabat velcro - Bas de manches réglables avec patte de serrage velcro Col doublé polaire - Capuche zippée dans le col avec cordon de serrage. Matière: 100% polyester oxford 300D

RÉF. ART.	DESCRIPTION	TAILLE	COULEUR
EP008125OMS	PARKA 4 EN 1 ORANGE/MARINE LOGO BYES CLASSES	S	ORANGE/ BLEU
EP008125OMM		M	ORANGE/ BLEU
EP008125OML		L	ORANGE/ BLEU
EP008125OMXL		XL	ORANGE/ BLEU
EP008125OM2XL		XXL	ORANGE/ BLEU
EP008125OM3XL		XXXL	ORANGE/ BLEU

PARKA 4 EN 1 HV LOGO HORIZON
CŒUR/DOS JAUNE/MARINE

T 2 S



RÉF. ART.	TAILLE	COULEUR
EP017823JMS	S	Jaune/Marine
EP017823JMM	M	Jaune/Marine
EP017823JML	L	Jaune/Marine
EP017823JMXL	XL	Jaune/Marine
EP017823JM2XL	2XL	Jaune/Marine
EP017823JM3XL	3XL	Jaune/Marine

PARKA FEMME 4 EN 1 HV LOGO
HORIZON CŒUR/DOS JAUNE/MARINE

T 2 S



Parka femme 4/1 HV respirant 4 logos HORIZON coeur et dos jaune / marine XS

RÉF. ART.	DESCRIPTION	TAILLE	COULEUR
EP017821JMXS	PARKA FEMME 4/1 HV LOGO HORIZON CŒUR/DOS JAUNE/MARINE	XS	Jaune/ Marine
EP017821JMS		S	Jaune/ Marine
EP017821JMM		M	Jaune/ Marine
EP017821JML		L	Jaune/ Marine

photos non contractuelles

PARKA 4 EN 1 HV 'CHEF DE MANŒUVRE' JAUNE / VERT



Tissu polyester imper-respirant. Manches montées. Doublure de propreté en maille ajourée. Capuche comprenant un cordon de serrage avec bloqueurs et réglage à l'arrière. Bas de manches avec patte de serrage auto-agrippante et poignets bord côte à l'intérieur. Fermeture centrale à glissière avec rabat fermé par auto-agrippant. Bandes rétro réfléchissantes microbilles RETHIO-TEX® cousues

RÉF. ART.	DESCRIPTION	TAILLE	COULEUR
EP009175JVM		M	JAUNE/ VERT
EP009175JVL		L	JAUNE/ VERT
EP009175JVXL	PARKA 4 EN 1 HV RESPIRANT 'CHEF DE MANŒUVRE' JAUNE / VERT	XL	JAUNE/ VERT
EP009175JV2XL		XXL	JAUNE/ VERT
EP009175JV3XL		XXXL	JAUNE/ VERT

PARKA 4 EN 1 FEMME LOGO WIZOM DOS INT./EXT.

T 2 S



ORANGE / MARINE

RÉF. ART.	DESCRIPTION	TAILLE
EP018706OMXS		XS
EP018706OMS	PARKA 4/1 FEMME LOGO WIZOM DOS INT./EXT.	S
EP018706OMM	O/M	M
EP018706OML		L

PARKA 4 EN 1 HOMME LOGO WIZOM DOS INT./EXT.

T 2 S



ORANGE / MARINE

RÉF. ART.	DESCRIPTION	TAILLE
EP018705OMS		S
EP018705OMM		M
EP018705OML	PARKA 4/1 HOMME LOGO WIZOM DOS INT./EXT.	L
EP018705OMXL	O/M	XL
EP018705OM2XL		2XL
EP018705OM3XL		3XL

PARKA FEMME HV

COVERGUARD

Parka polyester non respirant Extérieur en polyester Oxford enduit PU imperméable fluorescent (70% polyester et 30 % polyuréthane) Couleurs sombres en polyester Oxford enduit PVC imperméable (70 % polyester et 30 % PVC) Coutures étanchées Doublure en polyester taffetas 190T Isolation en polyester 180g/m2 Bandes rétro réfléchissantes (2 en ceinture, 2 brassards par manche, 2 bretelles dos et devant) Fermeture à glissière double sens avec rabat pressions Manches avec poignets coupe-vent tricot inté

RÉF. ART.	TAILLE	COULEUR
EP008469JAXS	XS	JAUNE/BLEU
EP008469JAS	S	JAUNE/BLEU
EP008469JAM	M	JAUNE/BLEU
EP008469JAL	L	JAUNE/BLEU
EP008469ORXS	XS	ORANGE/BLEU
EP008469ORS	S	ORANGE/BLEU
EP008469ORM	M	ORANGE/BLEU
EP008469ORL	L	ORANGE/BLEU

PARKA HOMME HV

COVERGUARD

Parka polyester non respirant Extérieur en polyester Oxford enduit PU imperméable fluorescent (70% polyester et 30 % polyuréthane) Couleurs sombres en polyester Oxford enduit PVC imperméable (70 % polyester et 30 % PVC) Coutures étanchées Doublure en polyester taffetas 190T Isolation en polyester 180g/m2 Bandes rétro réfléchissantes (2 en ceinture, 2 brassards par manche, 2 bretelles dos et devant) Fermeture à glissière double sens avec rabat pressions Manches avec poignets coupe-vent tricot inté

RÉF. ART.	TAILLE	COULEUR
EP008130JMS	S	JAUNE/BLEU
EP008130JMM	M	JAUNE/BLEU
EP008130JML	L	JAUNE/BLEU
EP008130JMXL	XL	JAUNE/BLEU
EP008130JM2XL	XXL	JAUNE/BLEU
EP008130JM3XL	XXXL	JAUNE/BLEU
EP008130OMS	S	ORANGE/BLEU
EP008130OMM	M	ORANGE/BLEU
EP008130OML	L	ORANGE/BLEU
EP008130OMXL	XL	ORANGE/BLEU
EP008130OM2XL	XXL	ORANGE/BLEU
EP008130OM3XL	XXXL	ORANGE/BLEU

PARKA HV BYES ORANGE/MARINE

COVERGUARD



Parka polyester non respirant Extérieur en polyester Oxford enduit PU imperméable fluorescent (70% polyester et 30 % polyuréthane) Couleurs sombres en polyester Oxford enduit PVC imperméable (70 % polyester et 30 % PVC) Coutures étanchées Doublure en polyester taffetas 190T Isolation en polyester 180g/m2 Bandes rétro réfléchissantes (2 en ceinture, 2 brassards par manche, 2 bretelles dos et devant) Fermeture à glissière double sens avec rabat pressions Manches avec poignets coupe-vent tricot inté

RÉF. ART.	DESCRIPTION	TAILLE	COULEUR
EP008129OMS		S	ORANGE/BLEU
EP008129OMM		M	ORANGE/BLEU
EP008129OMXL	PARKA ORANGE FLUO ET MARINE HI VIZ LOGO BYES	XL	ORANGE/BLEU
EP008129OML		L	ORANGE/BLEU
EP008129OM2XL		XXL	ORANGE/BLEU

photos non contractuelles

PARKA RIPSTOP NAVY/BLACK

COVERGUARD



100 % polyester pongée enduit PVC, imperméable, coutures étanchées Liseré rétroréfléchissant démarquant l'empiecement haut jusqu'au poignet Matière intérieure : haut polaire noire 100 % polyester, bas 100 % polyamide matelassé Fermeture à glissière simple avec rabat auto agrippant Col droit à capuche intégrée Capuche doublée, serrage avec cordon réglable par bloque-cordon Manches doublées matelassées terminées par poignets élastiques, réglables par bandes agrippantes Serrage taille élastique ave

RÉF. ART.	TAILLE	COULEUR
EP008132MNS	S	BLEU/NOIR
EP008132MNM	M	BLEU/NOIR
EP008132MNL	L	BLEU/NOIR
EP008132MNXL	XL	BLEU/NOIR
EP008132MN2XL	XXL	BLEU/NOIR

PARKA YANG NOIR

COVERGUARD



Matière extérieure: Softshell (94% polyester / 6% Spandex), déperlant et respirant collé sur 100% polyester micro polaire. 310 g/m2 Doublure : tricot 100% polyester devant pour cacher les poches Fermeture à glissière jusqu'en haut du col Glissières lisses Rabat cache col intérieur Capuche amovible Manches terminées par poignets élastiques réglables par bandes agrippantes Serrage bas élastique avec bloque cordons sur côtés intérieurs 1 poche haut, verticale à glissière 2 poches bas, verticales à

RÉF. ART.	DESCRIPTION	TAILLE	COULEUR
EP008135NOS		S	NOIR
EP008135NOM		M	NOIR
EP008135NOXL	PARKA YANG 2 NOIR	XL	NOIR
EP008135NOL		L	NOIR
EP008135NO2XL		XXL	NOIR
EP008135NO3XL		XXXL	NOIR

photos non contractuelles

PARKA YANG AXIONE NOIR

COVERGUARD



Matière extérieure: Softshell (94% polyester / 6% Spandex), déperlant et respirant collé sur 100% polyester micro polaire. 310 g/m2 Doublure : tricot 100% polyester devant pour cacher les poches Fermeture à glissière jusqu'en haut du col Glissières lisses Rabat cache col intérieur Capuche amovible Manches terminées par poignets élastiques réglables par bandes agrippantes Serrage bas élastique avec bloque cordons sur côtés intérieurs 1 poche haut, verticale à glissière 2 poches bas, verticales à

RÉF. ART.	TAILLE
EP020282NOS	S
EP020282NOM	M
EP020282NOL	L
EP020282NOXL	XL
EP020282NO2XL	2XL
EP020282NO3XL	3XL

PARKA YANG BYES NOIR

COVERGUARD



Matière extérieure: Softshell (94% polyester / 6% Spandex), déperlant et respirant collé sur 100% polyester micro polaire. 310 g/m2 Doublure : tricot 100% polyester devant pour cacher les poches Fermeture à glissière jusqu'en haut du col Glissières lisses Rabat cache col intérieur Capuche amovible Manches terminées par poignets élastiques réglables par bandes agrippantes Serrage bas élastique avec bloque cordons sur côtés intérieurs 1 poche haut, verticale à glissière 2 poches bas, verticales à

RÉF. ART.	DESCRIPTION	TAILLE	COULEUR
EP008133NOS		S	NOIR
EP008133NOM		M	NOIR
EP008133NOL	PARKA YANG NOIR BYES TAILLE	L	NOIR
EP008133NOXL		XL	NOIR
EP008133NO2XL		XXL	NOIR
EP008133NO3XL		XXXL	NOIR

AUTRES VETEMENTS LOGOTES

RÉF. ART.	DESCRIPTION
EP2---	Si vous souhaitez un vêtement logoté, contactez votre interlocuteur Distrimo

photos non contractuelles

JEAN'S FEMME BRODERIE BY BAT IDF DEVANT GAUCHE

CEPOVET



SUR COMMANDE DELAI 3 SEMAINES - AJOUTER 30 €UROS
DE TRANSPORT PAR COMMANDE

RÉF. ART.	DESCRIPTION	TAILLE
EP020305JET36		T36
EP020305JET38		T38
EP020305JET40		T40
EP020305JET42		T42
EP020305JET44		T44
EP020305JET46	JEAN'S	T46
EP020305JET48		T48
EP020305JET50		T50
EP020305JET52		T52
EP020305JET54		T54
EP020305JET56		T56
EP020305JET58		T58

JEAN'S HOMME BRODERIE BY BAT IDF DEVANT GAUCHE

CEPOVET



SUR COMMANDE DELAI 3 SEMAINES - AJOUTER 30 €UROS
DE TRANSPORT PAR COMMANDE

RÉF. ART.	DESCRIPTION	TAILLE
EP020304JET36		T36
EP020304JET38		T38
EP020304JET40		T40
EP020304JET42		T42
EP020304JET44		T44
EP020304JET46		T46
EP020304JET48	JEAN'S	T48
EP020304JET50		T50
EP020304JET52		T52
EP020304JET54		T54
EP020304JET56		T56
EP020304JET58		T58
EP020304JET60		T60

photos non contractuelles

JEAN'S HOMME BRODERIE BBGO DEVANT GAUCHE

CEPOVET



Matières : 65 % coton 35 % polyester 280 gr. 2 poches plaquées.
2 poches cuisses à soufflet sous rabat fermé par pressions.

RÉF. ART.	DESCRIPTION	TAILLE	COULEUR
EP020802JET36		36	JEAN
EP020802JET38		38	JEAN
EP020802JET40		40	JEAN
EP020802JET42		42	JEAN
EP020802JET44		44	JEAN
EP020802JET46		46	JEAN
EP020802JET48	JEAN'S HOMME BRODERIE BY BAT GO	48	JEAN
EP020802JET50	DEVANT GAUCHE	50	JEAN
EP020802JET52		52	JEAN
EP020802JET54		54	JEAN
EP020802JET56		56	JEAN
EP020802JET58		58	JEAN
EP020802JET60		60	JEAN

PANTALON DE PLUIE ORANGE

PORTWEST LTD



NON RESPIRANT 100% Polyester enduit PVC 170g Doublure:
100% Polyester filet 60g - Imperméable haute visibilité de qualité.
Protège de la pluie et du vent Conçue pour que l'utilisateur soit
visible et en sécurité pendant les intempéries.

RÉF. ART.	TAILLE	COULEUR
EP008116NRS	S	ORANGE
EP008116NRM	M	ORANGE
EP008116NRL	L	ORANGE
EP008116NRXL	XL	ORANGE
EP008116NR2XL	XXL	ORANGE

RÉFÉRENCE ARTICLE	TAILLE	COULEUR
EP008116NR3XL	XXXL	ORANGE
EP008116RES	S	ORANGE
EP008116REM	M	ORANGE
EP008116REL	L	ORANGE
EP008116REXL	XL	ORANGE
EP008116RE2XL	XXL	ORANGE
EP008116RE3XL	XXXL	ORANGE

VESTE MULTIRISQUE BYES COEUR+DOS

SIOEN



we life

Veste bleu marine multirisque tissus sio safe extra, deux passant
au dessus des poches poitrine, col droit, 2 poches poitrine plaqués
+ rabat + boutons pression invisibles pvc, dos allongé, fermeture
à glissière avec boutons pression invisible pvc, élastique sur oulet
en bas de la manche, logo brodé rétro réfléchissant devant coeur,
porche intérieure côté gauche fermeture velcro, 2 poches plaqués
+ rabat + boutons pressio invisibles pvc, logo dos transfert rétro
réfléchissant ; CE 0493 - EN ISO

RÉF. ART.	DESCRIPTION	TAILLE	COULEUR
EP017761BMT00	SIO SAFE EXTRA BL. MAR.	0	Marine
EP017761BMT01		1	Marine
EP017761BMT02		2	Marine
EP017761BMT03		3	Marine
EP017761BMT04		4	Marine
EP017761BMT05		5	Marine
EP017761BMT06		6	Marine
EP017761BMT07		7	Marine
EP017761BMT08		8	Marine

photos non contractuelles

PANTALON MULTIRISQUE BYES SIO SAFE EXTRA ENTREJAMBE 75

SIOEN

we
life

Pantalon bleu marine multirisque tissus sio safe extra, fermeture à glissière et bouton jeans invisible, poche côté gauche avec rabat et 2 boutons pression invisibles pvc, poche côté droit avec rabat et 2 boutons pression invisibles pvc + poche téléphone, couvre reins, 2 poches italiennes + rabat + bouton pression invisible pvc, 7 passants pour ceinture + un passant plus large, 2 poches genoux avec ouverture en bas, poche plaquée avec rabat et 2 boutons pression invisible pvc ; CE 0493 - EN ISO 136

RÉF. ART.	TAILLE	COULEUR
EP017762BMT00	0	Marine
EP017762BMT01	1	Marine
EP017762BMT02	2	Marine
EP017762BMT03	3	Marine
EP017762BMT04	4	Marine
EP017762BMT05	5	Marine
EP017762BMT06	6	Marine
EP017762BMT07	7	Marine
EP017762BMT08	8	Marine

PANTALON MULTIRISQUE BYES SIO SAFE EXTRA ENTREJAMBE 80

SIOEN

we
life

Pantalon bleu marine multirisque tissus sio safe extra, fermeture à glissière et bouton jeans invisible, poche côté gauche avec rabat et 2 boutons pression invisibles pvc, poche côté droit avec rabat et 2 boutons pression invisibles pvc + poche téléphone, couvre reins, 2 poches italiennes + rabat + bouton pression invisible pvc, 7 passants pour ceinture + un passant plus large, 2 poches genoux avec ouverture en bas, poche plaquée avec rabat et 2 boutons pression invisible pvc ; CE 0493 - EN ISO 136

RÉF. ART.	TAILLE	COULEUR
EP017763BMT00	0	Marine
EP017763BMT01	1	Marine
EP017763BMT02	2	Marine
EP017763BMT03	3	Marine
EP017763BMT04	4	Marine
EP017763BMT05	5	Marine
EP017763BMT06	6	Marine
EP017763BMT07	7	Marine
EP017763BMT08	8	Marine

photos non contractuelles

PANTALON MULTIRISQUE BYES SIO SAFE EXTRA ENTREJAMBE 85

SIOEN

we
life

Pantalon bleu marine multirisque tissus sio safe extra, fermeture à glissière et bouton jeans invisible, poche côté gauche avec rabat et 2 boutons pression invisibles pvc, poche côté droit avec rabat et 2 boutons pression invisibles pvc + poche téléphone, couvre reins, 2 poches italiennes + rabat + bouton pression invisible pvc, 7 passants pour ceinture + un passant plus large, 2 poches genoux avec ouverture en bas, poche plaquée avec rabat et 2 boutons pression invisible pvc ; CE 0493 - EN ISO 136

RÉF. ART.	TAILLE	COULEUR
EP017764BMT00	0	Marine
EP017764BMT01	1	Marine
EP017764BMT02	2	Marine
EP017764BMT03	3	Marine
EP017764BMT04	4	Marine
EP017764BMT05	5	Marine
EP017764BMT06	6	Marine
EP017764BMT07	7	Marine
EP017764BMT08	8	Marine

PANTALON MULTIRISQUE BYES SIO SAFE EXTRA ENTREJAMBE 90

SIOEN

we
life

Pantalon bleu marine multirisque tissus sio safe extra, fermeture à glissière et bouton jeans invisible, poche côté gauche avec rabat et 2 boutons pression invisibles pvc, poche côté droit avec rabat et 2 boutons pression invisibles pvc + poche téléphone, couvre reins, 2 poches italiennes + rabat + bouton pression invisible pvc, 7 passants pour ceinture + un passant plus large, 2 poches genoux avec ouverture en bas, poche plaquée avec rabat et 2 boutons pression invisible pvc ; CE 0493 - EN ISO 136

RÉF. ART.	TAILLE	COULEUR
EP017765BMT00	0	Marine
EP017765BMT01	1	Marine
EP017765BMT02	2	Marine
EP017765BMT03	3	Marine
EP017765BMT04	4	Marine
EP017765BMT05	5	Marine
EP017765BMT06	6	Marine
EP017765BMT07	7	Marine
EP017765BMT08	8	Marine

photos non contractuelles

VESTE RETARD FEU BYES COEUR + DOS SIO FLAME BLEU MARINE

SIOEN



we ♥ life

Veste bleu marine retard feu tissus sio flame, deux passant au dessus des poches poitrine, col droit, 2 poches poitrine plaqués + rabat + boutons pression invisibles pvc, dos allongé, fermeture à glissière avec boutons pression invisible pvc, élastique sur oulet en bas de la manche, logo brodé rétro réfléchissant devant coeur, poche intérieure côté gauche fermeture velcro, 2 poches plaqués + rabat + boutons pressio invisibles pvc, logo dos transfert rétro réfléchissant ; CE - EN ISO 13688:2013,

RÉF. ART.	TAILLE	COULEUR
EP017766BMT00	0	Marine
EP017766BMT01	1	Marine
EP017766BMT02	2	Marine
EP017766BMT03	3	Marine
EP017766BMT04	4	Marine
EP017766BMT05	5	Marine
EP017766BMT06	6	Marine
EP017766BMT07	7	Marine
EP017766BMT08	8	Marine

PANTALON RETARD FEU BYES SIO FLAME ENTREJAMBE 75 BLEU MARINE

SIOEN



we ♥ life

Pantalon bleu marine multirisque tissus sio safe extra, fermeture à glissière et bouton jeans invisible, poche côté gauche avec rabat et 2 boutons pression invisibles pvc, poche côté droit avec rabat et 2 boutons pression invisibles pvc + poche téléphone, couvre reins, 2 poches italiennes + rabat + bouton pression invisible pvc, 7 passants pour ceinture + un passant plus large, 2 poches genoux avec ouverture en bas, poche plaquée avec rabat et 2 boutons pression invisible pvc ; CE - EN ISO 13688:20

RÉF. ART.	TAILLE	COULEUR
EP017767BMT00	0	Marine
EP017767BMT01	1	Marine
EP017767BMT02	2	Marine
EP017767BMT03	3	Marine
EP017767BMT04	4	Marine
EP017767BMT05	5	Marine
EP017767BMT06	6	Marine
EP017767BMT07	7	Marine
EP017767BMT08	8	Marine

PANTALON RETARD FEU BYES SIO FLAME ENTREJAMBE 80 BLEU MARINE

SIOEN

we
life

Pantalon bleu marine multirisque tissus sio safe extra, fermeture à glissière et bouton jeans invisible, poche côté gauche avec rabat et 2 boutons pression invisibles pvc, poche côté droit avec rabat et 2 boutons pression invisibles pvc + poche téléphone, couvre reins, 2 poches italiennes + rabat + bouton pression invisible pvc, 7 passants pour ceinture + un passant plus large, 2 poches genoux avec ouverture en bas, poche plaquée avec rabat et 2 boutons pression invisible pvc ; CE - EN ISO 13688:20

RÉF. ART.	TAILLE	COULEUR
EP017768BMT00	0	Marine
EP017768BMT01	1	Marine
EP017768BMT02	2	Marine
EP017768BMT03	3	Marine
EP017768BMT04	4	Marine
EP017768BMT05	5	Marine
EP017768BMT06	6	Marine
EP017768BMT07	7	Marine
EP017768BMT08	8	Marine

PANTALON RETARD FEU BYES SIO FLAME ENTREJAMBE 85 BLEU MARINE

SIOEN

we
life

Pantalon bleu marine multirisque tissus sio safe extra, fermeture à glissière et bouton jeans invisible, poche côté gauche avec rabat et 2 boutons pression invisibles pvc, poche côté droit avec rabat et 2 boutons pression invisibles pvc + poche téléphone, couvre reins, 2 poches italiennes + rabat + bouton pression invisible pvc, 7 passants pour ceinture + un passant plus large, 2 poches genoux avec ouverture en bas, poche plaquée avec rabat et 2 boutons pression invisible pvc ; CE - EN ISO 13688:20

RÉF. ART.	TAILLE	COULEUR
EP017769BMT00	0	Marine
EP017769BMT01	1	Marine
EP017769BMT02	2	Marine
EP017769BMT03	3	Marine
EP017769BMT04	4	Marine
EP017769BMT05	5	Marine
EP017769BMT06	6	Marine
EP017769BMT07	7	Marine
EP017769BMT08	8	Marine

photos non contractuelles

PANTALON RETARD FEU BYES SIO FLAME ENTREJAMBE 90 BLEU MARINE

SIOEN



Pantalon bleu marine multirisque tissus sio safe extra, fermeture à glissière et bouton jeans invisible, poche côté gauche avec rabat et 2 boutons pression invisibles pvc, poche côté droit avec rabat et 2 boutons pression invisibles pvc + poche téléphone, couvre reins, 2 poches italiennes + rabat + bouton pression invisible pvc, 7 passants pour ceinture + un passant plus large, 2 poches genoux avec ouverture en bas, poche plaquée avec rabat et 2 boutons pression invisible pvc ; CE - EN ISO 13688:20

RÉF. ART.	TAILLE	COULEUR
EP017770BMT00	0	Marine
EP017770BMT01	1	Marine
EP017770BMT02	2	Marine
EP017770BMT03	3	Marine
EP017770BMT04	4	Marine
EP017770BMT05	5	Marine
EP017770BMT06	6	Marine
EP017770BMT07	7	Marine
EP017770BMT08	8	Marine

PANTALON WX3 SERVICE 280 GR GRIS / NOIR

PORTWEST LTD



RÉF. ART.	TAILLE
EP020675GNT38	38
EP020675GNT40	40
EP020675GNT42	42
EP020675GNT44	44
EP020675GNT46	46
EP020675GNT48	48
EP020675GNT50	50
EP020675GNT52	52
EP020675GNT54	54
EP020675GNT56	56
EP020675GNT58	58
EP020675GNT60	60

photos non contractuelles

SOUS-VETEMENT BAS DU CORPS

93% POLYESTER MECHE 7% SPANDEX



RÉF. ART.	DESCRIPTION	TAILLE
EP017847NOXS		XS
EP017847NOS		S
EP017847NOM		M
EP017847NOL	Noir	L
EP017847NOXL		XL
EP017847NO2XL		XXL

SOUS-VETEMENT HAUT DU CORPS

PORTWEST



Le T-shirt ML base Pro intègre un traitement aux ions d'argent qui combat les odeurs et augmente la longévité. Le tissu est près du corps pour une performance optimale et adapté pour une utilisation multi-saison.

Caractéristiques : Conçu avec un ajustement confortable Contraste coutures de couleur plus plus de classe Tissu extérieur: Ion d'argent 165g

RÉF. ART.	DESCRIPTION	TAILLE
EP104712NOS		S
EP104712NOM		M
EP104712NOL	93% POLYESTER MECHE 7% SPANDEX	L
EP104712NOXL		XL
EP104712NO2XL		XXL

photos non contractuelles

COMBINAISON BLANCHE SPECIAL PLOMB RESPIRANTE SUR PAR 20

3M

COMBINAISON BLANCHE 3M SPECIAL PLOMB RESPIRANTE - TAILLES S A 4XL

RÉF. ART.	DESCRIPTION
EP008023	COMBINAISON BLANCHE SPECIAL PLOMB RESPIRANTE PAR 20

COMBINAISON DE LAVAGE ETANCHE

SIOEN

PVC SUPPORT COTON

RÉF. ART.	TAILLE
EP005553L	L
EP005553XL	XL

COMBINAISON DE PLUIE HIVER

PORTWEST LTD

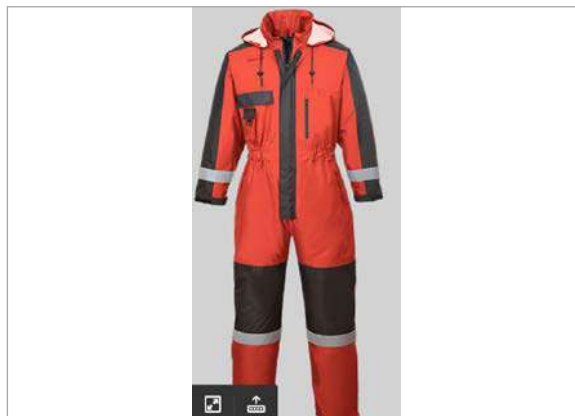

RÉF. ART.	DESCRIPTION	TAILLE
EP020803RNS		S
EP020803RNM		M
EP020803RNL	ROUGE/NOIR	L
EP020803RNXL		XL
EP020803RN2XL		2XL

COMBINAISON JETABLE BLANC CAT 3

COVERGUARD

we life

Risques chimiques : types 4, 5 et 6 - Protection contre les particules radioactives - Traitement antistatique - Étanche aux agents biologiques

RÉF. ART.	DESCRIPTION	TAILLE	COULEUR
EP008238BCL	-TYPE 4,5,6 - + CONFORT L	L	BLANC
EP008238BCXL	-TYPE 4,5,6 - + CONFORT XL	XL	BLANC
EP008238BC2XL	-TYPE 4,5,6 - + CONFORT 2XL	XXL	BLANC

COMBINAISON JETABLE BLANCHE CAT 3

COVERGUARD

we
life

Risques chimiques : types 5 et 6 - Protection contre les particules radioactives - Traitement antistatique

RÉF. ART.	DESCRIPTION	TAILLE	COULEUR
EP008237BCL		L	BLANC
EP008237BCXL	- TYPES 5 ET 6	XL	BLANC
EP008237BC2XL		XXL	BLANC

COMBINAISON JETABLE BLANCHE TYVEK CAT 3

DU POND Tyvek

we
lifeTYPES 5 ET 6 - + RESISTANT - Vêtement à usage limité. Combinaison à capuche en Tyvek. Élastique à la taille, poignée, visage et chevilles. Poches auto adhésives. Fermeture à glissière. TYVEK 41GR M² TYPE 5-6 CAT.III Risques chimiques : types 5 et 6 - Protection contre les particules radioactives - Traitement antistatique 41GR M² TYPE 5-6 CAT.III

RÉF. ART.	DESCRIPTION	TAILLE	COULEUR
EP008239BCL	COMBINAISON JETABLE BLANCHE TYVEK L CAT 3	L	BLANC
EP008239BCXL	COMBINAISON JETABLE BLANCHE TYVEK XL CAT 3	XL	BLANC
EP008239BC2XL	COMBINAISON JETABLE BLANCHE TYVEK 2XL CAT 3	XXL	BLANC

COMBINAISON JETABLE BLEUE TYVEK CAT 3

DU POND Tyvek

we
lifeTYPES 5 ET 6 - + RESISTANT - Vêtement à usage limité. Combinaison à capuche en Tyvek. Élastique à la taille, poignée, visage et chevilles. Poches auto adhésives. Fermeture à glissière. TYVEK 41GR M² TYPE 5-6 CAT.III Risques chimiques : types 5 et 6 - Protection contre les particules radioactives - Traitement antistatique 41GR M² TYPE 5-6 CAT.III

RÉF. ART.	DESCRIPTION	TAILLE	COULEUR
EP008239BLL	COMBINAISON JETABLE BLEUE TYVEK L CAT 3	L	BLEU
EP008239BLXL	COMBINAISON JETABLE BLEUE TYVEK XL CAT 3	XL	BLEU
EP008239BL2XL	COMBINAISON JETABLE BLEUE TYVEK 2XL CAT 3	XXL	BLEU

photos non contractuelles

COTTE A BRETelles RESPIRANTE PLUIE HV

PORTWEST



Imperméable et respirant avec coutures adhésives pour empêcher la pénétration de l'eau 6 poches pour plus de rangement Poche téléphone Poche arrière Double poche mètre Dos élastiqué Ouverture latérale réglable pour un meilleur ajustement Tissu extérieur: Respirant 300D 190g

RÉF. ART.	DESCRIPTION	TAILLE
EP104708ORS		S
EP104708ORM		M
EP104708ORL		L
EP104708ORXL	NON DOUBLEE ORANGE	XL
EP104708OR2XL		XXL
EP104708OR3XL		XXXL

ENSEMBLE DE PLUIE JAUNE PVC

COVERGUARD



Matière extérieure : double enduction PVC support coton/polyester, imperméable, épaisseur 0.32 mm cousu et soudé. Vestes Longueur Vestes : 85 cm. Fermeture Vestes à glissière avec rabat à pressions. Col capuche. Capuche fixe avec cordelette de serrage Manches terminées intérieur par coupe-vent élastique. Dos ventilé 2 poches bas droites avec rabat horizontal Serrage bas Vestes avec cordelette de serrage Pantalon Serrage taille Pantalon élastique Bas jambes à pression 1 poche passe main droit Braguet

RÉF. ART.	TAILLE	COULEUR
EP008241JAM	M	JAUNE
EP008241JAL	L	JAUNE
EP008241JAXL	XL	JAUNE
EP008241JA2XL	XXL	JAUNE

photos non contractuelles

ENSEMBLE DE PLUIE ORANGE FLUO/MARINE BYES

COVERGUARD



we ♥ life

Veste : Bandes retro réfléchissantes cousues. Doublure : filet 100% polyester. Aérations : dos et devant. Fermeture : à glissière simple sous triple rabat avec boutons pression, jusqu'en haut du col à capuche intégrée. Poches : 2 poches bas plaquées avec rabat a bandes agrippantes. Pantalon : Bandes retro réfléchissantes cousues. Taille élastique 2 passe-mains. Mollets extérieur : ouvertures a glissière avec soufflet et serrage par bouton pression. Coutures soudées et étanchées

RÉF. ART.	DESCRIPTION	TAILLE	COULEUR
EP008414OML		L	ORANGE/ BLEU
EP008414OMM		M	ORANGE/ BLEU
EP008414OMXL	ENSEMBLE DE PLUIE ORANGE FLUO/MARINE COUT ETAN. - BYES	XL	ORANGE/ BLEU
EP008414OM2XL		XXL	ORANGE/ BLEU

ENSEMBLE DE PLUIE ORANGE FLUO/ MARINE COUTURES ETANCHES

COVERGUARD

we
life

Veste : Bandes retro réfléchissantes cousues. Doublure : filet 100% polyester. Aérations : dos et devant. Fermeture : à glissière simple sous triple rabat avec boutons pression, jusqu'en haut du col à capuche intégrée. Poches : 2 poches bas plaquées avec rabat a bandes agrippantes. Pantalon : Bandes retro réfléchissantes cousues. Taille élastique 2 passe-mains. Mollets extérieur : ouvertures a glissière avec soufflet et serrage par bouton pression. Coutures soudées et étanchées

RÉF. ART.	DESCRIPTION	TAILLE	COULEUR
EP008413OML	ENSEMBLE DE PLUIE ORANGE FLUO/ MARINE COUT ETAN	L	ORANGE/ BLEU
EP008413OMM		M	ORANGE/ BLEU
EP008413OMXL		XL	ORANGE/ BLEU
EP008413OM2XL		XXL	ORANGE/ BLEU

ENSEMBLE DE PLUIE ORANGE FLUO/ MARINE RESPIRANT BYES

COVERGUARD

we
life

Veste : Bandes retro réfléchissantes cousues. Fermeture : à glissière simple jusqu'en haut du col sous rabat bandes agrippantes. Poches : 2 poches bas plaquées avec rabat a bandes agrippantes. Pantalon : Bandes retro réfléchissantes cousues. Taille élastique 2 passe-mains. Mollets extérieur : Serrage par bouton pression.

RÉF. ART.	DESCRIPTION	TAILLE	COULEUR
EP008412OML	ENSEMBLE DE PLUIE ORANGE FLUO/ MARINE RESPIRANT - BYES	L	ORANGE/ BLEU
EP008412OMM		M	ORANGE/ BLEU
EP008412OMXL		XL	ORANGE/ BLEU
EP008412OM2XL		XXL	ORANGE/ BLEU

ENSEMBLE DE PLUIE ORANGE FLUO/ MARINE RESPIRANT

COVERGUARD



Veste : Bandes retro réfléchissantes cousues. Fermeture : à glissière simple jusqu'en haut du col sous rabat bandes agrippantes. Poches : 2 poches bas plaquées avec rabat a bandes agrippantes. Pantalon : Bandes retro réfléchissantes cousues. Taille élastique 2 passe-mains. Mollets extérieur : Serrage par bouton pression.

RÉF. ART.	TAILLE	COULEUR
EP008240OML	L	ORANGE/BLEU
EP008240OMM	M	ORANGE/BLEU
EP008240OMXL	XL	ORANGE/BLEU
EP008240OM2XL	XXL	ORANGE/BLEU

photos non contractuelles

ENSEMBLE DE PLUIE SOUPLE

COVERGUARD



Veste : Longueur Veste 85 cm. Fermeture à glissière avec rabat pressions. Col officier à capuche intégrée fermeture à glissière. Capuche fixe, cordelette de serrage. Manches terminées intérieur par coupevent élastique. Dos ventilé. 2 poches bas droites à rabat horizontal. Serrage bas avec cordelette de serrage. Pantalon : Pantalon serrage taille. Pantalon serrage bas. 2 poches passe-mains.

RÉF. ART.	TAILLE	COULEUR
EP005080JAL	L	JAUNE
EP005080JAM	M	JAUNE
EP005080JAXL	XL	JAUNE
EP005080JA2XL	XXL	JAUNE
EP005080JA3XL	XXXL	JAUNE

ENSEMBLE DE PLUIE VERT

PVC SOUDE



RÉF. ART.	DESCRIPTION	TAILLE	COULEUR
		M	VERT
		L	VERT
EP008241VEXL	PVC -	XL	VERT
EP008241VE2XL		XXL	VERT

photos non contractuelles

MANCHETTES ELAGUEUR



we
life

RÉF. ART.	DESCRIPTION
EP010569	ANTI COUPURE PROTECTION 360°

ELARGISSEUR JAMBIERES ELAGUEUR



we
life

RÉF. ART.	DESCRIPTION
EP010572	

PROTECTION D'ÉPAULE SPAL

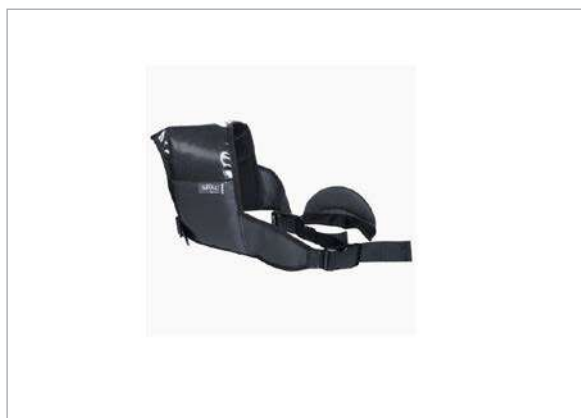

RÉF. ART.	DESCRIPTION
EP017902	

ENROULEUR DE CEINTURE POUR BADGE



RÉF. ART.	DESCRIPTION
EP002156	LONG.80CM

JAMBIERES ELAGUEUR ANTI COUPURE



we
life

RÉF. ART.	DESCRIPTION
EP010571	

BRASSARD PORTE BADGE



RÉF. ART.	DESCRIPTION
EP010187	

photos non contractuelles

PORTE BADGE GLISSIERE IDS76



RÉF. ART.

EP003687

TABLIER DE SOUDEUR SINGER FRERES

SINGER
safety



we
life

RÉF. ART.	DESCRIPTION	LONGUEUR
EP005447	TABLIER DE SOUDEUR	L 90 CM

TABLIER DE SOUDEUR LEBON

LEBON



we
life

RÉF. ART.	DESCRIPTION	LONGUEUR
EP005448	TABLIER DE SOUDEUR	L 110 CM

CEINTURE NOIRE 1200X30MM COTON BOUCLE PLASTIQUE

CEINTURE NOIRE 1200X30MM COTON BOUCLE PLASTIQUE SANS MARQUAGE POLYBAG INDIVIDUEL



RÉF. ART. LONGUEUR

EP000501 L 120 CM

GENOILLERES

PRO-FLEX

colle sous leau®



Les genouillères ProFlex 335 « usage Intensif » sont munies de coquilles dures, surdimensionnées et comportent des surfaces de protection autour du genou.

RÉF. ART.	DESCRIPTION
EP002342	GENOILLERE PROFLEX 335
EP007052	- I.GEL
EP002341	HYGROVET P/POCHE PANT.TRAVAIL

photos non contractuelles

BOTTE CUIR FOURREE JALARTIC

JALLATTE



embouts acier semelles antiperforation

RÉF. ART.	TAILLE
EP005530P36	P36
EP005530P37	P37
EP005530P38	P38
EP005530P39	P39
EP005530P40	P40
EP005530P41	P41
EP005530P42	P42
EP005530P43	P43
EP005530P44	P44
EP005530P45	P45
EP005530P46	P46
EP005530P47	P47
EP005530P48	P48

BOTTE CUIR NON FOURREE JALASKA

JALLATTE



embouts acier semelles antiperforation

RÉF. ART.	TAILLE
EP005529P38	P38
EP005529P39	P39
EP005529P40	P40
EP005529P41	P41
EP005529P42	P42
EP005529P43	P43
EP005529P44	P44
EP005529P45	P45
EP005529P46	P46
EP005529P47	P47
EP005529P48	P48

BOTTE DE SECURITE LAVAGE HAUTE PRESSION

KARSHER



RÉF. ART.	DESCRIPTION	TAILLE
EP005541P39		39
EP005541P40		40
EP005541P41		41
EP005541P42		42
EP005541P43		43
EP005541P44	800B	44
EP005541P45		45
EP005541P46		46
EP005541P47		47
EP005541P48		48

photos non contractuelles

BOTTE POLYURETHANE



we
life

BOTTES Polyuréthane Pointe et semelle intercalaire en acier
Huiles & graisses minérales, animales & végétales, désinfectants, divers solvants et produits chimiques. La botte de sécurité Purofort originale assure fonction et confort. Isolée jusqu'à -20°C, elle garde au chaud par temps froid. Résistante et durable, la botte Professional est idéale pour quantité d'environnements industriels.

RÉF. ART.	TAILLE
EP005543P36	P36
EP005543P37	P37
EP005543P38	P38
EP005543P39	P39
EP005543P40	P40
EP005543P41	P41
EP005543P42	P42
EP005543P43	P43
EP005543P44	P44
EP005543P45	P45
EP005543P46	P46
EP005543P47	P47

BOTTE PVC



we
life

embouts acier - semelles antiperforation S5

RÉF. ART.	TAILLE
EP005544P37	P37
EP005544P38	P38
EP005544P39	P39
EP005544P40	P40
EP005544P41	P41
EP005544P42	P42
EP005544P43	P43
EP005544P44	P44
EP005544P45	P45
EP005544P46	P46
EP005544P47	P47
EP005544P48	P48

CHAUSSURE BASSE DUCIE

LEMAITRE

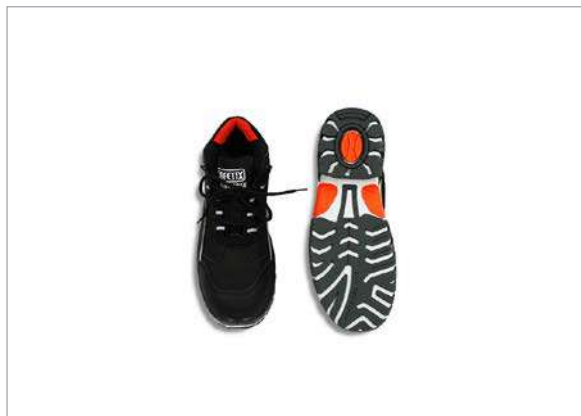
we
life

Cuir pleine fleur finition nubuck noir avec bandes réfléchissantes
- Embout polycarbonate - Semelle anti-perforation souple textile -
Absence total de Métal

RÉF. ART.	TAILLE
EP008197P39	P39
EP008197P40	P40
EP008197P41	P41
EP008197P42	P42
EP008197P43	P43
EP008197P44	P44
EP008197P45	P45
EP008197P46	P46
EP008197P47	P47

CHAUSSURE BASSE LACET ALES

LEMAITRE

we
life

RÉF. ART.	DESCRIPTION	TAILLE
EP009804P38		P38
EP009804P39		P39
EP009804P40		P40
EP009804P41		P41
EP009804P42		P42
EP009804P43	GRIS/ORANGE	P43
EP009804P44		P44
EP009804P45		P45
EP009804P46		P46
EP009804P47		P47
EP009804P48		P48

CHAUSSURE BASSE VELCRO S1P

BASE PROTECTION

we
life

RÉF. ART.	DESCRIPTION	TAILLE
EP009921P39		P39
EP009921P40		P40
EP009921P41		P41
EP009921P42		P42
EP009921P43	SWIM SANS METAL	P43
EP009921P44		P44
EP009921P45		P45
EP009921P46		P46
EP009921P47		P47

CHAUSSURE HAUTE DIABLO

LEMAITRE

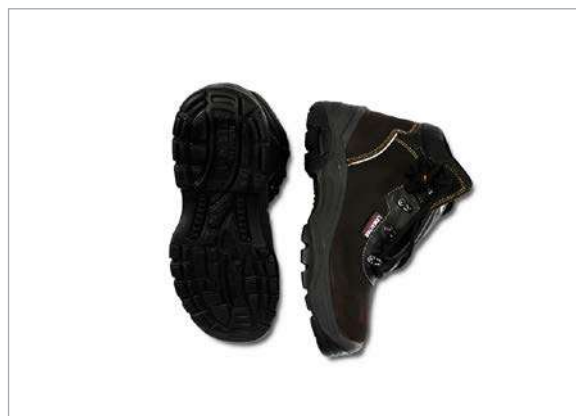
we
life

RÉF. ART.	TAILLE
EP008214P35	P35
EP008214P36	P36
EP008214P37	P37
EP008214P38	P38
EP008214P39	P39
EP008214P40	P40
EP008214P41	P41
EP008214P42	P42
EP008214P43	P43
EP008214P44	P44
EP008214P45	P45
EP008214P46	P46
EP008214P47	P47
EP008214P48	P48

photos non contractuelles

CHAUSSURE HAUTE DUNDEE

LEMAITRE



Cuir pleine fleur finition nubuck noir avec bandes réfléchissantes
- Embout polycarbonate - Semelle anti-perforation souple textile - Absence total de Métal

RÉF. ART.	TAILLE
EP008215P39	P39
EP008215P40	P40
EP008215P41	P41
EP008215P42	P42
EP008215P43	P43
EP008215P44	P44
EP008215P45	P45
EP008215P46	P46
EP008215P47	P47

CHAUSSURE HAUTE LACET SOUDEUR

HONEYWELL



RÉF. ART.	DESCRIPTION	TAILLE
EP008778P38		P38
EP008778P39		P39
EP008778P40		P40
EP008778P41		P41
EP008778P42		P42
EP008778P43	ARGONO	P43
EP008778P44		P44
EP008778P45		P45
EP008778P46		P46
EP008778P47		P47
EP008778P48		P48

CHAUSSURE HAUTE LACET ALBI

LEMAITRE



RÉF. ART.	DESCRIPTION	TAILLE
EP009803P38		P38
EP009803P39		P39
EP009803P40		P40
EP009803P41		P41
EP009803P42		P42
EP009803P43	GRIS/ORANGE	P43
EP009803P44		P44
EP009803P45		P45
EP009803P46		P46
EP009803P47		P47
EP009803P48		P48

CHAUSSURE MONTANTE CALGARY

UPOWER



Tige souple cuir pull-up hydrofuge avec sur embout renforcé - Embout composite (200 Joules) - Semelle antiperforation composite - Semelle PU

RÉF. ART.	DESCRIPTION	TAILLE
EP008428P38		P38
EP008428P39		P39
EP008428P40		P40
EP008428P41		P41
EP008428P42		P42
EP008428P43	- 0% METAL	P43
EP008428P44		P44
EP008428P45		P45
EP008428P46		P46
EP008428P47		P47
EP008428P48		P48

photos non contractuelles

CHAUSSURE MONTANTE JALBORG STEEL

JALLATTE



RÉF. ART.	DESCRIPTION	TAILLE
EP017131P35		P35
EP017131P36		P36
EP017131P37		P37
EP017131P38		P38
EP017131P39		P39
EP017131P40		P40
EP017131P41	SAS	P41
EP017131P42		P42
EP017131P43		P43
EP017131P44		P44
EP017131P45		P45
EP017131P46		P46
EP017131P47		P47
EP017131P48		P48

CHAUSSURE MONTANTE JALOSBERN STEEL FOURREE

JALLATTE



CHAUSSURES HAUTES FOURREE - Chaussure montante type ranger, coloris naturel Chaussure montante type ranger, coloris naturel Tige en cuir pleine fleur AP23, hydrofuge et oléofuge. Matelassage de haute de tige, doublé cuir, pour une meilleure protection du tendon d'achille Chaussant ergonomique, avec embout large en polymère de synthèse perforé Semelle en Softane bi matière équipée d'un absorbeur de choc

RÉF. ART.	TAILLE
EP008390P35	P35
EP008390P36	P36
EP008390P37	P37
EP008390P38	P38
EP008390P39	P39
EP008390P40	P40
EP008390P41	P41
EP008390P42	P42
EP008390P43	P43
EP008390P44	P44
EP008390P45	P45
EP008390P46	P46
EP008390P47	P47
EP008390P48	P48

photos non contractuelles

CHAUSSURE MONTANTE JORAN

LEMAITRE

we
life

Tige en cuir pull up hydrofuge, épaisseur 2,2mm pour une meilleure résistance mécanique (abrasion, déchirure, perforation) et durabilité. Col et languette soufflet souples et matelassés pour un meilleur confort. Fermeture par oeillets et passants plastique. Crochets sur la partie haute et soufflet large pour un laçage et délaçage faciles. Embout en polycarbonate injecté, plus léger et ergonomique, élastique, amagnétique et isolant thermique. Double insert anti perforation en acier inoxydable et

RÉF. ART.	TAILLE
EP008228P35	P35
EP008228P36	P36
EP008228P37	P37
EP008228P38	P38
EP008228P39	P39
EP008228P40	P40
EP008228P41	P41
EP008228P42	P42
EP008228P43	P43
EP008228P44	P44
EP008228P45	P45
EP008228P46	P46
EP008228P47	P47
EP008228P48	P48

CHAUSSURES HAUTES SAHARA

LEMAITRE



CHAUSSURES HAUTES SAHARA S3 P50

RÉF. ART.	DESCRIPTION	TAILLE
EP008430P50	S3 P50	P50

CUISSARDES DE SECURITE S5



Embout acier 200J - Intercalaire anti-perforation acier - semelle antistatique - Soudure à chaud fréquence garantie 100% étanche - Bretelles de maintien en nylon - Attachje en plastique noir - Œillets et bouton clou en laiton - Lacet de maintien à la poitrine - Poche intérieure - Hauteur en 130 cm - Protection des malléoles, du dessus du pied et talon.

RÉF. ART.	DESCRIPTION	TAILLE
EP004807P37		P37
EP004807P38		P38
EP004807P39		P39
EP004807P40		P40
EP004807P41		P41
EP004807P42	CUISSARDES DE SECURITE - S5	P42
EP004807P43		P43
EP004807P44		P44
EP004807P45		P45
EP004807P46		P46
EP004807P47		P47

SUR CHAUSSURE VISITEUR SBP

we
life

RÉF. ART.	TAILLE
EP005548NOX	P35/39
EP005548NOY	P40/44
EP005548NOZ	P45/48

photos non contractuelles

SURCHAUSSURE INTÉGRALE MILLENIUM FULL PROTECT

GASTON MILLE



JUSQU'À EPUISEMENT

RÉF. ART.	TAILLE
EP018312S	S
EP018312M	M
EP018312L	L

SIGNIFICATION DISTRIPLUS & WE LOVE LIFE



RÉF. ART.
PICTOS

SOLUTION RECYCLAGE CASQUES ELECTROPORTATIFS



RÉF. ART.
RECYCLAGE

photos non contractuelles

BOMBE DESINFECTANTE DESODORISANTE

GRUPE ALP



BOMBE DESINFECTANTE DESODORISANTE SPECIAL EPI: pour chaussures, casque, gants... Fongicide, bactéricide, bombe de 300ml

RÉF. ART.	DESCRIPTION
EP004886	SPECIAL EPI

CHAUSSETTE DE TRAVAIL

TRICOTAGE DES VOSGES



RÉF. ART.	DESCRIPTION	TAILLE
EP020437NOYB	LOT DE 2 PAIRES NOIR 39 À 42	39 à 42
EP020437NOZB	LOT DE 2 PAIRES NOIR 43 À 46	43 à 46

CHAUSSETTE FROID EXTREME NOIR

PORTWEST LTD



chaussettes spécialement conçues pour le froid extrême, avec 2 couches - Extérieur 60% laine, intérieur 40% nylon - 100% Viafil - anti odeur, anti moisissure et isolant très efficace

RÉF. ART.	DESCRIPTION	TAILLE
EP017026NOZA	CHAUSSETTE FROID EXTREME NOIR 44 À 48	P44/48
EP017026NOXC	39 À 43	P39/43

CHAUSSON COSMOS POUR BOTTE

GRUPE ALP



Protège efficacement du froid. Il est également apprécié en été pour sa grande capacité d'absorption de la sueur. Coussin isothermique de confort amélioré grâce à sa mousse intercalaire. Élastique plat pour un bon maintien à la cheville. Très bonne résistance aux frottements des chaussons dans la botte Lavable en machine : 40 °C. Extérieur jersey, 100 % polyester Intercalaires en mousse micro-cellulaire isothermique

RÉF. ART.	DESCRIPTION	TAILLE
EP008410GSP37	P36/37	P36/37
EP008410GSP39	P38/39	P38/39
EP008410GSP41	P40/41	P40/41
EP008410GSP43	P42/43	P42/43
EP008410GSP45	P44/45	P44/45
EP008410GSP47	P46/47	P46/47
EP008410GSP49	P48/49	P48/49

photos non contractuelles

GRAISSE CUIR BOITE METAL

GRUPE ALP



En soumettant mes chaussures à l'eau, au béton et au froid, le cuir s'abîme et sèche. Afin de prolonger leur durée de vie, je les protège efficacement contre le séchage du cuir avec notre graisse pour cuir

RÉF. ART.	DESCRIPTION
EP005137	100 ML

GUETRES ELAGUEUR



RÉF. ART.	DESCRIPTION
EP010570	ANTI COUPURE

LACET POUR CHAUSSURE



RÉF. ART.	DESCRIPTION	LONGUEUR
EP002515	HAUTE	L 90 CM
EP002514	MONTANTE	L 120 CM

SEMELLE ANTI GLISSE



Semelle avec crampons adaptables sur chaussures

RÉF. ART.	DESCRIPTION	TAILLE
EP005425YA	41/44	P41/44
EP005425ZA	44/48	P44/48
EP005425XA	SEMELLE ANTI-GLISSE 37/41	P37/41

photos non contractuelles

SEMELLE ISOTHERMIQUE

GRUPE ALP



Semelle en feutre anti-froid

RÉF. ART.	TAILLE
EP005547P38	P38
EP005547P39	P39
EP005547P40	P40
EP005547P41	P41
EP005547P42	P42
EP005547P43	P43
EP005547P44	P44
EP005547P45	P45
EP005547P46	P46
EP005547P47	P47

SUR BOTTES SEMELLE CAOUTCHOUC

TYVEK



RÉF. ART.	DESCRIPTION
EP018250	ANTIDERAPANTE TYVEK CART 100 PAIRES

SUR BOTTES JETABLES

LAPRO



Photo Lapro.

SURBOTTES

we life

RÉF. ART.	DESCRIPTION
EP100490	- CART 150 PAIRES

SUR CHAUSSURE ANTI-DERAPANTE



we life

RÉF. ART.	DESCRIPTION
EP007043	CART 250 PAIRES

SUR CHAUSSURE



we life

RÉF. ART.	DESCRIPTION
EP007042	CART 250 PAIRES

photos non contractuelles

ANTICHUTE SUR CORDE ASAP

PETZL

we
life

RÉF. ART.	DESCRIPTION
EP020815	FOURNI SANS MOUSQUETON

DESCENDEUR RIG

PETZL

we
life

Conçu pour les travaux sur corde pour les utilisateurs expérimentés. Poignée multifonction permettant, selon la situation : - de libérer la corde et contrôler la descente avec la main sur le brin libre, - de s'immobiliser au poste de travail sans clé d'arrêt. Système de retour automatique de la poignée pour limiter les risques en cas d'action involontaire. Position de rangement de la poignée pour réduire les risques d'accrochage lorsque le descendeur est porté au harnais. Dispose d'un cliquet de ver

RÉF. ART.
EP010534

POIGNEE JUMAR ASCENSION

PETZL

we
life

Simple à utiliser et efficace : - poignée surmoulée ergonomique permettant d'assurer une préhension à la fois confortable et puissante, - ouverture large permettant de saisir facilement la poignée, même avec des gants épais, - partie supérieure ergonomique pour maximiser la puissance lors d'une traction à deux mains, - taquet totalement intégré au corps du bloqueur pour éviter tout accrochage involontaire, - gâchette à picots avec fente d'évacuation pour optimiser le fonctionnement, quelles que

RÉF. ART.	DESCRIPTION
EP010535	DROITE
EP010536	GAUCHE

POULIE



Flasques spécifiques adaptés à l'utilisation de nœud autobloquant Prusik dans les systèmes anti-retour. Réa sur roulement à billes étanche pour assurer un excellent rendement. Légère et compacte. Compatibilité corde: 7 à 11 mm Diamètre de réa: 25 mm Roulement à billes: oui

Rendement: 91 % Charge d'utilisation maximale: 2,5 kN x 2 = 5 kN Poids: 80 g Certification(s): CE EN 12278, NFPA 1983 Technical Use

RÉF. ART.	DESCRIPTION
EP010542	MINI
EP010543	GEMINI
EP020758	PARTNER ULTRA COMPACTE A HAUT RENDEMENT
EP020759	PRO TRAXION BLOQUEUR IMPERDABLE A TRES HAUT RENDEMENT
EP020760	TANDEM DOUBLE POUR DEPLACEMENT SUR CORDE

BLOQUEUR CROLL BLOQUEUR VENTRAL



RÉF. ART.
EP020722

COULISSEAU ANTI-CHUTE

TRACTEL



RÉF. ART.	DESCRIPTION
EP001512	AP10-2 POUR DRISSE Ø 10MM

COULISSEAU ANTICHUTE P/CABLE

MILLER

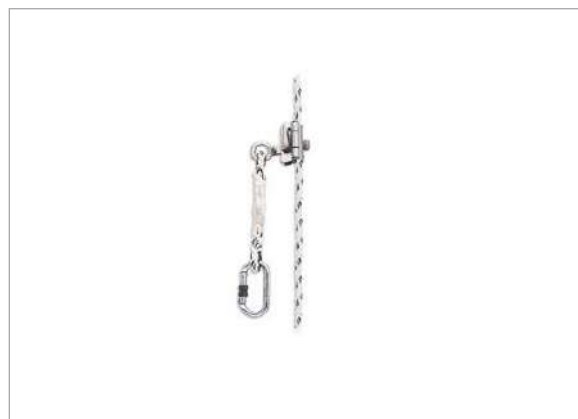

COULISSEAU ANTICHUTE MILLER POUR CABLE VERTICAL Ø 8MM AVEC PETIT DISSIPATEUR

RÉF. ART.	DESCRIPTION
EP020676	VERT Ø 8MM AV/PETIT DISSIPATEUR

COULISSEAU ANTICHUTE STOPFORMSP

TRACTEL

we
life

COULISSEAU ANTICHUTE STOPFORMSP POUR CORDAGE D14 (prev RéfEP001471)

RÉF. ART.	DESCRIPTION
EP020431	P/CORD. D14 (PREV EP001471)

COULISSEAU AUTOMATIQUE ET MANUEL POUR CORDE D.12

HONEYWELL



SANS LONGE DE CONNEXION RG-500

RÉF. ART.
EP104639

COULISSEAU ANTI-CHUTE

MILLER

RÉF. ART.	DESCRIPTION
EP020762	SOLLBODY CONTROL II

COULISSEAU FABAL-D150 KG

TRACTEL

we
life

RÉF. ART.	DESCRIPTION
EP020764	RAIL FABAL A12 ET AL2

ANTICHUTE STOPCABLE

TRACTEL

we
life

RÉF. ART.	DESCRIPTION
EP020763	AVEC ABSORBEUR - 150KG
EP020782	CABLOC AVEC MOUSQUETON ZINGUE

CHARIOT HACA MULTISAFE POUR PYLONE

TYPE COULISSEAU SUR PYLONE



SUR COMMANDE

we
life

RÉF. ART.
EP100557

photos non contractuelles

ANCRAGE INDIVIDUEL REUTILISABLE POUR ANTICHUTE

KRATOS SAFETY



we
life

RÉF. ART.	DESCRIPTION
EP960001	- INLOCK

PROTECTION DE CORDE PROTECNOIR SOUPLE

PETZL



we
life

RÉF. ART.
EP020761

GAINE DE PROTECTION MILLER CORDE OUVRABLE

MILLER



we
life

GAINE DE PROTECTION - MILLER Corde Ouvrable 1010214 - Protection supplémentaire sur cordage

RÉF. ART.
EP002330

BRETELLE DE MAINTIEN BLOQUEUR

PETZL



we
life

RÉF. ART.	DESCRIPTION
EP020723	TORSE SECUR

PEDALE REGLABLE EN SANGLE FOOTAPE

PETZL

we
life

RÉF. ART.

EP020725

PERCHE TÉLÉSCOPIQUE

MILLER

SUR COMMANDE
we
life

PERCHE TELESCOPIQUE Longueur dépliée 6.05 m.

Longueur repliée : 1.45 m

Permet de fixer un point d'ancrage à distance.

RÉF. ART. DESCRIPTION

EP017209 6ML05

EP017208 9ML40

ADAPTATEUR DE PERCHE

MILLER

SUR COMMANDE
we
life

Adaptateur de direction compatible avec adaptateur universel pour Crochetvit et super rapidex

RÉF. ART.

EP017213

SUPER RAPIDEX POUR PERCHE

MILLER

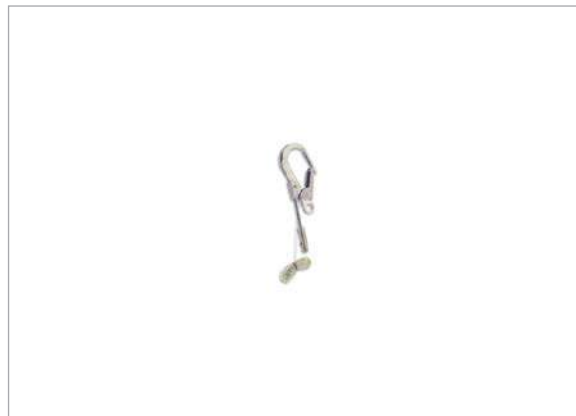
SUR COMMANDE
we
life

SUPER RAPIDEX POUR PERCHE Ouverture : 65 mm Poids : 1,05 kg Connecteur en Aluminium

RÉF. ART.

EP017211

photos non contractuelles

CROCHET GO 100

MILLER



CROCHET GO 100 Ouverture : 110 mm Poids : 1,48 kg Connecteur en Aluminium

RÉF. ART.
EP017212

CROCHEVIT POUR PERCHE

MILLER



CROCHEVIT POUR PERCHE Ouverture : 150 mm Poids : 1,3 kg Connecteur en Aluminium

RÉF. ART.
EP017210

PROLONGATEUR DORSAL SANGLE

MILLER



RÉF. ART.	DESCRIPTION	LONGUEUR
EP020159	SANS MOUSQUETON	42CM

CONNECTEUR ALLIAGE ALU LEGER

MILLER



RÉF. ART.	DESCRIPTION
EP001408	GO60A VERROUILLAGE 62MM

MAILLON RAPIDE TRIANGULAIRE ACIER



RÉF. ART.	DESCRIPTION
EP020724	DELTA N°10

photos non contractuelles

MOUSQUETON 1/4 DE TOUR

MILLER

we
life

Ouverture 20mm - Aluminium

RÉF. ART.	DESCRIPTION
EP003256	MILLER SUPER TOP
EP003260	MOUSQUETON DE SECURITE 1/4 DE TOUR - RK1

MOUSQUETON OK TRIACT LOCK

PETZL

we
life

RÉF. ART.	DESCRIPTION
EP020751	ALU 1/4 DE TOUR
EP100597	ALU 1/4 DE TOUR NOIR

MOUSQUETON OMNI TRIACT

PETZL

we
life

Mousqueton multidirectionnel pour : - fermer le harnais FALCON ASCENT en reliant les deux points d'attache, - connecter un bloqueur ventral CROLL (FALCON ASCENT). Résistance : 15 kN (dans toutes les directions). Système Keylock pour éviter l'accrochage involontaire du mousqueton durant les manœuvres. TRIACT-LOCK : système automatique à ouverture triple action, Matière(s): aluminium Certification(s): CE EN 362. 90gr / Résistance grand axe 20kN / Résistance petit axe 15 kN / Résistance doigt ouver

RÉF. ART.	DESCRIPTION
EP010541	-LOCK 1/4 DE TOUR PETZL

MOUSQUETON ACIER ZINGUE RK53

TRACTEL

we
life

OUVERTURE DE 60 MM - RK53

RÉF. ART.	DESCRIPTION
EP003259	- VERROUILLAGE AUTOMATIQUE

photos non contractuelles

SANGLE ANNEAU SANGLE COUSU POLYESTER

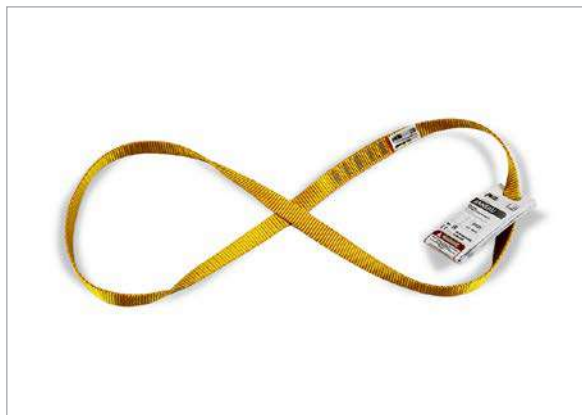

we
life

Anneau sangle polyester - Résistance 22kN - LAR 19MM

RÉF. ART.	DESCRIPTION	COULEUR	LONGUEUR	LAR-GEUR
EP000078	SANGLE ANNEAU COUSU POLYESTER 60 CM NOIR	NOIR	L 60 CM	I 19 MM
EP020753	SANGLE ANNEAU COUSU POLYESTER 60 CM JAUNE	JAUNE	L 60 CM	I 19 MM
EP000074	SANGLE ANNEAU COUSU POLYESTER 120 CM NOIR	NOIR	L 120 CM	I 19 MM
EP020754	SANGLE ANNEAU COUSU POLYESTER 120 CM VERT	VERT	L 120 CM	I 19 MM

SANGLE ANNEAU PETZL



we
life

RÉF. ART.	DESCRIPTION	LONGUEUR
EP010533	SANGLE ANNEAU 80 CM BLEU	L 80 CM
EP010532	SANGLE ANNEAU 150 CM ROUGE	L 150 CM

SANGLE ANNEAU MILLER

MILLER



CRAVATE SANGLE 1.20M - MILLER 1002918 - Cravate fournit au dispositif d'arrêt des chutes un point d'ancrage sûr autour d'une structure. Sangle polyester de 27mm. Résistance à la rupture >10 Kn. Conforme à la norme EN795b. Longueur : 1,20m.

RÉF. ART.	DESCRIPTION	LONGUEUR
EP004057	1.20 ML	L 120 CM

SANGLE ANNEAU TRACTEL

TRACTEL



we
life

RÉF. ART.	DESCRIPTION	LONGUEUR
EP000076	SANGLE ANNEAU 1.5 M - SAK1.5	L 150 CM

LONGE ABSORBEUR

PETZL

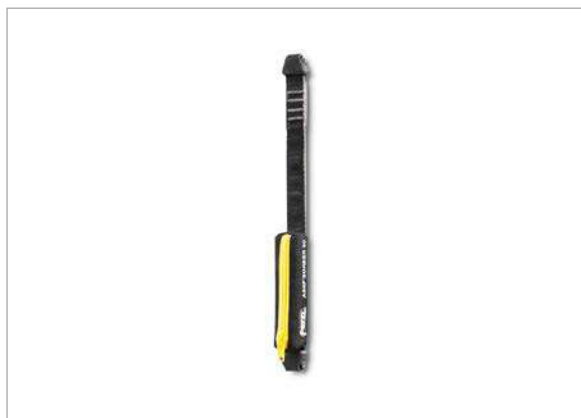
we
life

Relie l'antichute mobile ASAP ou ASAP LOCK au harnais. Permet à l'utilisateur d'éloigner la corde afin de : - libérer la zone de travail, - protéger la corde des outils coupants et de la projection de métaux en fusion. Absorbe l'énergie en cas de chute par déchirement de coutures spécifiques. Disponible en deux longueurs pour choisir le meilleur compromis entre éloignement de la corde et réduction de la hauteur de chute. Pochette en tissu avec zip de fermeture pour protéger l'absorbeur d'énergie

RÉF. ART.	DESCRIPTION	LONGUEUR
EP010530	40CM ASAP SORBEUR	L 40 CM

LONGE ABSORBEUR DRISSE

MILLER

we
life

Longe drisse antichute testée sur arêtes avec 2 mousquetons quart de tour en acier.

RÉF. ART.	DESCRIPTION	LONGUEUR
EP100875	2ML + 2QT ACIER 17MM TA	
EP100876	1,5ML + 2QT ACIER 17MM TA	
EP020153	1ML50 + 1QT + 1GO65 TA	L 150 CM

LONGE DE MAINTIEN TRACTEL

TRACTEL

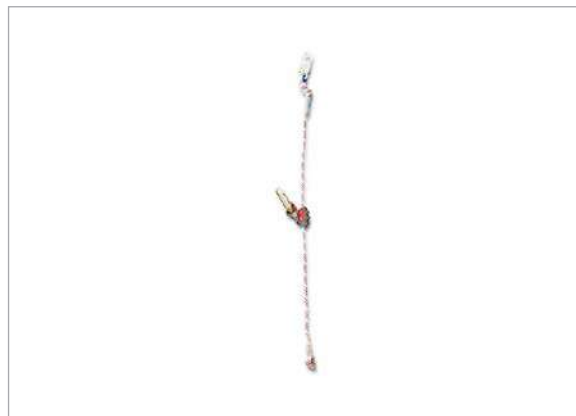
we
life

RÉF. ART.	DESCRIPTION	LONGUEUR
EP002710	LONGE DE MAINTIEN 2M -DRISSE Ø12,5-1 BLOQUEUR-1BOUCLE	L 200 CM

LONGE DE MAINTIEN GRILLON HOOK

PETZL

PETZL

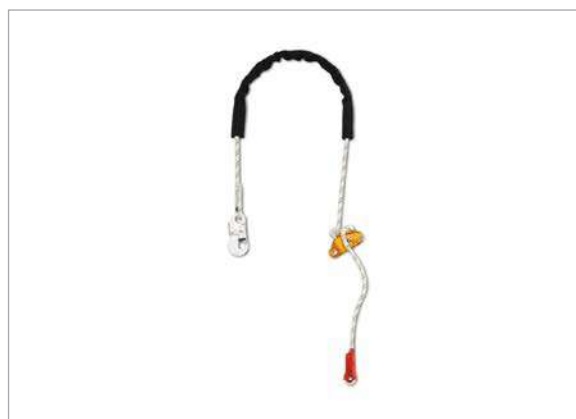
we
life

Longe avec système de réglage progressif permettant d'ajuster précisément la position de travail. S'utilise à double sur les points d'attache latéraux du harnais pour répartir la charge sur la ceinture (utilisateur en appui sur les pieds) : le réglage est réalisé en appuyant sur la came pivotante. Peut s'utiliser à simple sur le point d'attache ventral du harnais pour répartir la charge entre la ceinture et les cuisses (utilisateur en suspension) : le réglage est réalisé en actionnant la poignée

RÉF. ART.	DESCRIPTION	LONGUEUR
EP010529	LONGE DE MAINTIEN GRILLON HOOK LONG 2 METRES	L 200 CM

photos non contractuelles

LONGE DE MAINTIEN MILLER

MILLER

we
life

RÉF. ART.	DESCRIPTION	LONGUEUR
EP020154	LONGE DE MAINTIEN REGLEX 3000 3ML SANS GAINÉ	L 300CM
EP020155	LONGE DE MAINTIEN REGLEX MACHOIRE LONG. 2ML	L 200CM

LONGE DRISSE LD11 1M

TRACTEL

we
life

Longe en drisse de 11 mm sans absorbeur d'énergie, sans mousqueton

RÉF. ART.	DESCRIPTION	LONGUEUR
EP020297	LONGE DRISSE LD 11 2M AVEC 2 BOUCLES	L 200 CM

LONGE DE SECURITE

TRACTEL

we
life

Longe en drisse de 11 mm sans absorbeur d'énergie, sans mousqueton

RÉF. ART.	DESCRIPTION	LONGUEUR
EP002719	LD11 1M SANS ABSORBEUR AVEC 2 BOUCLES	L 100 CM

LONGE DOUBLE DE SECURITE

TRACTEL

we
life

RÉF. ART.	DESCRIPTION
EP100904	LONGE DOUBLE DRISSE LDAD 1,5M + ABSOR + 1QT M11 + 2M53
EP100905	SANS ABSORBEUR 1.5ML

LONGE DRISSE LD11 2M

TRACTEL

we
life

RÉF. ART.	DESCRIPTION
EP100906	LONGE DRISSE LDF 11 1M-11-53 1 MOUSQ.QT + 1 MOUSQ.M53

LONGE Y AVEC ABSORBEUR INTEGRE ET CONNECTEURS

PETZL

we
life

RÉF. ART.	DESCRIPTION
EP104623	MGO LG 80 CM

LONGE DOUBLE DRISSE

TRACTEL

we
life

SANS ABSORBEUR

RÉF. ART.	DESCRIPTION
EP104607	LDF 11 1M-11-53-53 1 MOUSQ.QT + 2 MOUSQ.M53

CORDE AXIS 11MM

PETZL

we
life

RÉF. ART.	DESCRIPTION	LONGUEUR	DIAMETRE
EP020781	BLANC 20ML TERMISAISON COUSUE		D 14 MM
EP010537	JAUNE/NOIRE100ML	L 100 M	

LONGE FOURCHE AV.ABSORBEUR DRISSE

MILLER

we
life

RÉF. ART.	DESCRIPTION
EP020156	2ML+QT+2GO55 ACIER TA

photos non contractuelles

CORDE PARAL. Ø 10,5MM





CORDE PARALLEL Ø 10,5 MM NOIRLG 200 M SOUPLE ET
LEGERE POURACCES DIFFICILE

RÉF. ART.	DESCRIPTION	DIAMETRE
EP020755	NOIR L.200 M P/ACCES DIFFICILE	D 10,5 MM

CORDAGE TORONNE Ø 14 MM

TRACTEL



RÉF. ART.	DESCRIPTION	LONGUEUR	DIAMETRE
EP001471	CORDAGE TORONNE DIA 14MM - 15M - CK15	L 15 M	D 14 MM

DRISSE TRESS Ø 11MM

TRACTEL



RÉF. ART.	DESCRIPTION	LONGUEUR	DIAMETRE
EP001956	-10 M-BOUCLE D'UN COTE/NOEUD A L'AUTRE	L 10 M	D 11 MM

ABSORBEUR D'ENERGIE EN SANGLE A
DECHIREMENT



RÉF. ART.	DESCRIPTION
EP020630	ABSORBICA

ANTICHUTE AUTO BLOCFOR

TRACTEL

we
lifeANTICHUTE A RAPPEL AUTOMATIQUE BLOCFOR ESD
10MOUSQUETON M10 - TOURILLON M47

RÉF. ART.	DESCRIPTION
EP020430	BLOCFOR ESD10 MOUSQ. M10 - TOURILLON M47
EP106421	BLOCFOR 1,8 ESD 11-47 1 MOUSQUETON M11 AUTOMATIQUE - 1 MOUSQUETON M47 AUTOMATIQUE

**ANTICHUTE ENROULEUR A RAPPEL
AUTOMATIQUE**

TRACTEL

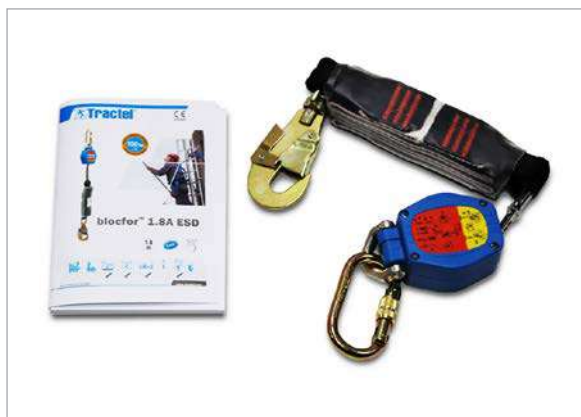
we
life

RÉF. ART.	DESCRIPTION	LONGUEUR
EP000079	1,5M - PK1,5-R47-R42	L 150 CM

**ANTICHUTE ENROULEUR A RAPPEL
AUTO**

MILLER

we
lifeTurboLite sangle 2 m avec 2 mousquetons 1/4 de tour - Charge
de travail maxi : 136kg haut et 100kg en point bas - Capacité
de travail : 2m - Tirant d'air : 1,80m si ancrage haut et 4,30m si
ancrage bas

RÉF. ART.	DESCRIPTION
EP000083	MILLER TURBOLITE - NACELLE

**ELINGUE MJ51 POUR ANCRAGE SUR
POUTRES - LONG 1M**

MILLER

Elingue en acier galvanisé de 6,3 mm avec gaine de protection en
plastique - Ouverture : Ø 300 mm (ou forme carrée 250 x 250
mm) - Résistance à la rupture : > 15 kN - Longueur 1m - Poids :
0,28 kg

RÉF. ART.	DIAMETRE
EP005057	D 11 MM

photos non contractuelles

SUPPORT D'ASSURAGE EN CORDE

MILLER



SUPPORT D'ASSURAGE EN CORDE MH00 - MILLER : Corde en polyamide toronnée pour coulisseaux sur corde 10/12mm LG 10ML

RÉF. ART.	DESCRIPTION
EP004138	MH00 - 10ML
EP004139	MH00 - 20ML

CRAVATE CÂBLE LONGUEUR

MILLER



CRAVATE CÂBLE LONGUEUR 1.50M Longueur 1.50 m. Poids : 0,716 kg Acier Galvanisé

RÉF. ART.	DESCRIPTION
EP017214	1ML50
EP017215	CRAVATTE CÂBLE LONGUEUR 1ML

LIGNE DE VIE TEMPORAIRE

TRACTEL



RÉF. ART.	DESCRIPTION
EP020433	TEMPO 3 - 3 PERSONNES MAX
EP020432	TIRSAFE+T3 CABLE 30M

VERIFIEZ LA DISPONIBILITE DE NOS PRODUITS

DISTRIMO



En scannant le QR code, vérifiez le stock des produits à l'aide des références et de la barre de recherche

RÉF. ART.	DESCRIPTION
SITE WEB	http://distrimo.bouygues-construction.com/

HARNAIS HT55 MODELE BOUYGUES

TRACTEL

we
life

RÉF. ART.	DESCRIPTION	TAILLE	COULEUR
EP010818S		S	ORANGE
EP010818M	AUTO-2 BOUCLES D'ACCROCHAGE	M	ORANGE
EP010818XL		XL	ORANGE

HARNAIS HT42 BOUCLES PLATES

TRACTEL

we
life

RÉF. ART.	DESCRIPTION	TAILLE
EP020434M	3 POINTS D'ACCROCHAGE	M

HARNAIS HT22 BOUCLES PLATES

TRACTEL

we
life

RÉF. ART.	DESCRIPTION	TAILLE
EP020435M	2 POINTS D'ACCROCHAGE	M
EP020435XL		

HARNAIS 4 POINTS RM

MILLER

we
life

RÉF. ART.	DESCRIPTION	TAILLE
EP008324S/M	HARNESS MILLER	S/M
EP008324L/XL		L/XL

8

photos non contractuelles

HARNAIS DESIGN DURAFLEX BOUCLES MANUELLES

MILLER

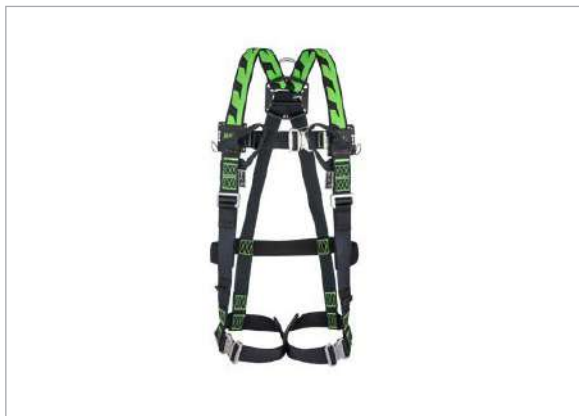

RÉF. ART.	TAILLE
EP020158T00	0
EP020158T01	1
EP020158T02	2
EP020158T03	3

HARNAIS BODY FIT DURAFLEX BOUCLES AUTOMATIQUES

MILLER

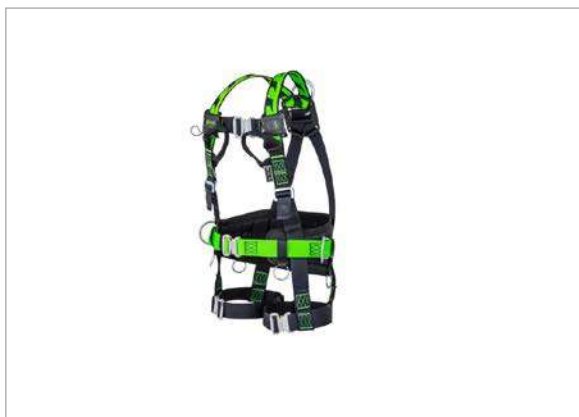

RÉF. ART.	TAILLE
EP020157T01	1
EP020157T02	2
EP020157T03	3

HARNAIS DURAFLEX 2 PTS SANGLE EPAULE ELAST.

MILLER

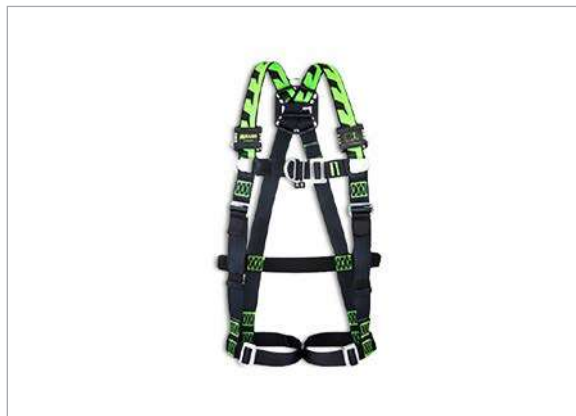

HARNAIS DURAFLEX SANGLE EPAULE ELASTIQUE - 2 POINTS
- BOUCLE AUTO - ATTACHE STERNALES : 2 GANSES TEXTILES

RÉF. ART.	DESCRIPTION	TAILLE
EP009983T01		T01
EP009983T02	BOUCLE AUTO	T02
EP009983T03		T03

HARNAIS MILLER REVOLUTION CONFORT R2

MILLER



RÉF. ART.	TAILLE
EP008302S/M	S/M
EP008302L/XL	L/XL
EP00830223XL	XXL

photos non contractuelles

HARNAIS MILLER REVOLUTION PREMIUM R5

MILLER

we
life

RÉF. ART.	DESCRIPTION	TAILLE
EP008303S/M		S/M
EP008303L/XL		L/XL
EP00830323XL		XXL

HARNAIS AVAO BOD CROLL FAST

PETZL

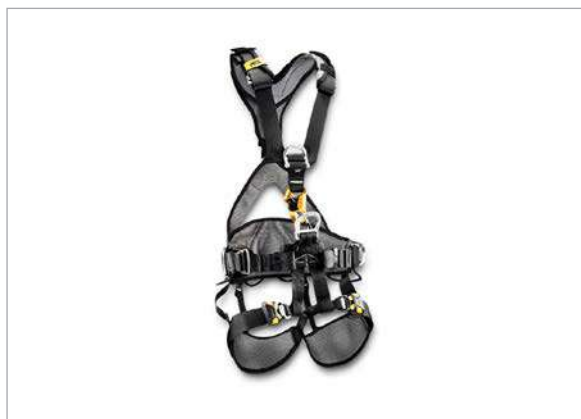
we
life

Bloqueur ventral CROLL intégré pour les remontées sur corde. Conception favorisant le confort : - construction dorsale ultra-enveloppante en forme de X pour limiter les points de tension lors des suspensions prolongées, - ceinture et tours de cuisse semi-rigides et larges pour un excellent maintien ; préformés et doublés de mousse matelassée respirante pour le confort en suspension, - bretelles en mousse, écartées du tour de cou, pour limiter les frottements ; en cas de charge sur la ceinture, el

RÉF. ART.	TAILLE
EP010528T00	T00
EP010528T01	T01
EP010528T02	T02

HARNAIS AVAO BOD FAST

PETZL

we
life

Conception favorisant le confort dans toutes les situations : - construction dorsale ultra-enveloppante en forme de X pour limiter les points de tension lors des suspensions prolongées, - ceinture et tours de cuisse semi-rigides et larges pour un excellent maintien ; préformés et doublés de mousse matelassée respirante pour le confort en suspension, - bretelles en mousse, écartées du tour de cou, pour limiter les frottements ; en cas de charge sur la ceinture, elles reprennent cette charge et la

RÉF. ART.	DESCRIPTION	TAILLE
EP010523T00		T00
EP010523T01	HARNAIS AVAO BOD CROLL FAST	T01
EP010523T02	T02 MODÈLE 2020	T02

KIT EPI CONFORT-ECHAFAUDAGE

TRACTEL

we
life

KIT EPI CONFORT-ECHAFAUDAGE HARNAIS (M) HT55 + LONGE Y 1M MOUSQ. M11 QT + 2 M53 + SAC

RÉF. ART.	DESCRIPTION
EP104660	(M) HT55 COMPLET AV/SAC

photos non contractuelles

KIT EPI STANDARD-ECHAFAUDAGE

TRACTEL

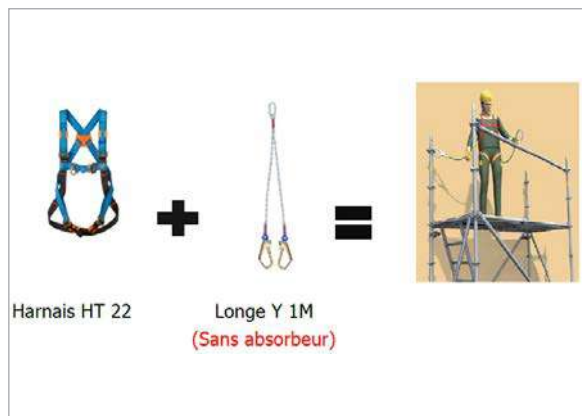

we life

KIT EPI STANDARD-ECHAFAUDAGE HARNAIS (M) HT22 + LONGE Y 1M MOUSQ. M11 QT + 2 M53 + SAC

RÉF. ART.	DESCRIPTION
EP104659	KIT EPI STD-ECHAFAUDAGE (M) HT22 COMPLET AVEC SAC

KIT EPI STANDARD-NACELLE 3A&3B

TRACTEL

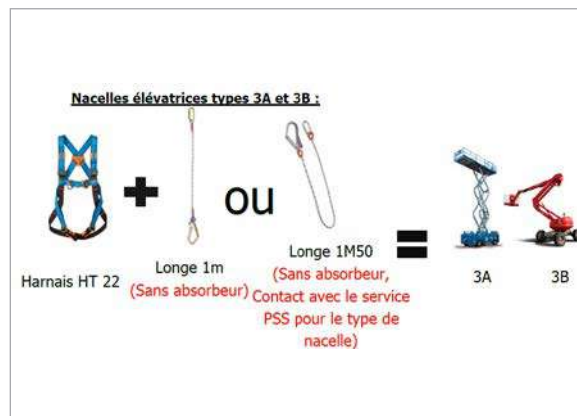

we life

KIT EPI STANDARD-NACELLE 3A&3B HARNAIS (M) HT22 + LONGE 1M MOUSQ. M11 QT + M53 + SAC

RÉF. ART.	DESCRIPTION
EP104661	(M) HT22 COMPLET +SAC

KIT EPI CONFORT-NACELLE 3A&3B

TRACTEL

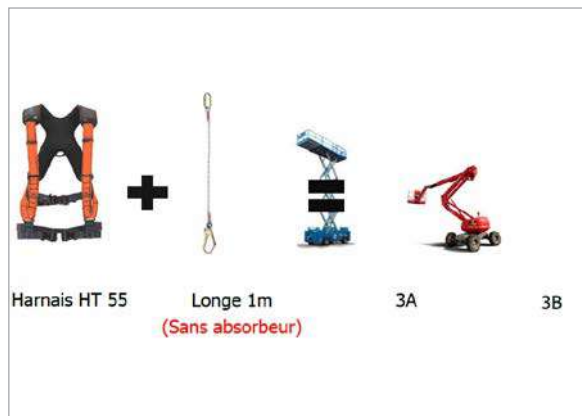

we life

KIT EPI CONFORT-NACELLE 3A&3B HARNAIS (M) HT55 + LONGE 1M MOUSQ. M11 QT + M53 + SAC

RÉF. ART.	DESCRIPTION
EP104662	(M) HT55 COMPLET+SAC

photos non contractuelles

GANT SOUDEUR TIG



we
life

RÉF. ART.	DESCRIPTION	TAILLE
EP008858	MANCHETTE DE 15 CM	T10

GANT SOUDEUR CUIR INTERIEUR
MOLLETONNE

COVERGUARD



we
life

RÉF. ART.
EP002333

TABLIER DE SOUDEUR SINGER FRERES

SINGER
safety



we
life

RÉF. ART.	DESCRIPTION	LONGUEUR
EP005447	TABLIER DE SOUDEUR	L 90 CM

TABLIER DE SOUDEUR LEBON

LEBON



we
life

RÉF. ART.	DESCRIPTION	LONGUEUR
EP005448	TABLIER DE SOUDEUR	L 110 CM

GUETRE SOUDEUR

SINGER



we
life

RÉF. ART.	DESCRIPTION
EP002402	- LA PAIRE

MASQUES SOUDEUR

VOIR SECTION "LUNETTES" POUR TROUVER L'ENSEMBLE DES MASQUES DE SOUDEUR



we
life

RÉF. ART.
EP002402

photos non contractuelles

GANT ELAGUEUR ANTI COUPURE



we
life

RÉF. ART.	DESCRIPTION	TAILLE
EP010568T8		T08
EP010568T9		T09
EP010568T10	AVEC RENFORT MAIN GAUCHE	T10
EP010568T11		T11
EP010568T12		T12

JAMBIERES ELAGUEUR ANTI COUPURE



we
life

RÉF. ART.
EP010571

MANCHETTES ELAGUEUR



we
life

RÉF. ART.	DESCRIPTION
EP010569	ANTI COUPURE PROTECTION 360°

ELARGISSEUR JAMBIERES ELAGUEUR



we
life

RÉF. ART.
EP010572

photos non contractuelles

CASQUE IRIS II PORTE-BADGE avec jugulaire

AUBOUEIX



RÉF. ART.	DESCRIPTION	COULEUR
EP105894BLNON	CASQUE IRIS II PORTE-BADGE LOGO Sans Sigle Bleu	BLEU

GUETRES ELAGUEUR



RÉF. ART.	DESCRIPTION
EP010570	ANTI COUPURE

ECRAN GRILLAGE POUR CASQUE IRIS II

HONEYWELL



IRIS II

RÉF. ART.
EP002009

photos non contractuelles

KIT ELECTRICIEN - ENSEMBLE EPI RISQUE ELECTRIQUE

CONTIENT: PAIRE DE GANTS ISOLANTS CL00 500V, PAIRE DE GANTS COTON, PAIRE DE SURGANTS DOMAINE BT, PAIRE DE LUNETTE, TAPIS ISOLANT, SAC DE TRANSPORT



we
life

RÉF. ART.

EP005643

KIT GILET + TRIANGLE



RÉF. ART.

EP005742

KIT SAC GRUTIER

COMPOSITION: 1 SAC A DOS, 1ASPIRATEUR SUR BATTERI, 1 VAPORISATEUR, 1 PAQUET DE LINGETTE, 1 PISTOLET AVEC PRODUIT VITRE, 1 SACHET DE POCHE A URINE



RÉF. ART.

EP005626

KIT EPI BUCHERON

CONTIENT : PAIRE DE GUÊTRE ÉLAGUEUR + PAIRE DE JAMBIÈRES ÉLAGUEUR + PAIRE DE MANCHETTES ÉLAGUEUR + PAIRE DE GANTS ÉLAGUEUR + VESTE ANTI COUPURE + CASQUE IRIS 2 BLEU + VISIÈRE + PAIRE DE COQUILLE ANTI BRUIT + SAC À DOS



we
life

RÉF. ART.

DESCRIPTION

EP017914

/ ÉLAGUEUR GANT T10 - VESTE XL

EP018207

/ ÉLAGUEUR GANT T9 - VESTE L

SAC A DOS

MILLER



Toile PVC - sac réglable et renforcé - contenance : 60 L = 200 m de drisse Ø 10mm - 680x550x200mm - 1.230kg

RÉF. ART.	DESCRIPTION
EP004021	60 L

SAC A DOS MILLER POUR HARNAIS

MILLER



HAUTEUR 400MM - LARGEUR 300MM - PROFONDEUR 150MM - EN NYLON - LOGOTE BYES

RÉF. ART.	DESCRIPTION
EP008147NOBES	- MARQUAGE BYES
EP008147NONON	- SANS MARQUAGE

SACOCHE A OUTILS MILLER

MILLER



RÉF. ART.	DESCRIPTION
EP018581	REVO REFERMABLE

SACOCHE GRAND MODELE

MILLER



RÉF. ART.	DESCRIPTION
EP004053	33X23X10CM MILLER

**POCHETTE TOOLBAG JAUNE 5 LITRES
PORTE OUTILS****PETZL**

RÉF. ART.
EP020756

we
life

photos non contractuelles

SAC DE TRANSPORT



Ceinture, bretelles et dos matelés pour un meilleur confort lors des longs portages. Rabat supérieur avec pochette d'identification intérieure. Corps et fond en bâche soudée pour une plus grande résistance (sans PVC). Tanka de fermeture facile à manipuler, développé pour les environnements difficiles. Poignées sur le côté et sur le haut du sac pour le portage à la main. Anneau supérieur pour le hissage. Anneau intérieur pour suspendre le sac en position ouverte. Poids: 1250 g Volume: 45 litre

RÉF. ART.	DESCRIPTION
EP010524	45L

SAC A DOS SPORT



RÉF. ART.	DESCRIPTION	COULEUR
EP008148ORBTP	Orange BY TP	NOIR / ORANGE
EP008148ORBGO	NOIR Orange BY BAT GRAND OUEST	NOIR / ORANGE
EP008148ORNON	NOIR - ZIP ORANGE SS SIGLE	NOIR / ORANGE
EP008148NONON	NOIR SS SIGLE	NOIR / NOIR

SAC PAQUETAGE TROLLEY



RÉF. ART.	DESCRIPTION
EP017191	BY BAT IDF NOIR SUR ROULETTE
EP018738	HRE 75X30X30X30 NOIR-NOIR

SAC PAQUETAGE



RÉF. ART.	DESCRIPTION
EP020783	SAC DE TRANSPORT AXIONE MARINE 26X34X67 CM
EP004039	MARINE BYES 67 x 26 x 34 cm
EP004047	NOIR BY ENERGIES SERVICES 72X38X34

SAC PERSONNEL JAUNE 15 LITRES



RÉF. ART.
EP020757

photos non contractuelles

SAC A DOS POUR KIT GRUTIER

RÉF. ART.

EP004022

SAC BALLAST

T 2 S



SAC A DOS BALLAST 30 L 46X22X33CM - POLY 1200 D Jaune
SS SIGLE

RÉF. ART.	DESCRIPTION
EP020419JANON	30 L 46X22X33CM-POLY 1200D JA S/SIGLE
EP020419ORNON	30L 46X22X33CM-POLY 1200D OR S/SIGLE

SAC ELECTRICIEN

TOP BAGAGE INTERNATIONAL



SAC A DOS ELECTRICIEN 35 L 39X44X20CM - POLY 1200 D
Orange SS SIGLE

RÉF. ART.	DESCRIPTION
EP020417ORNON	SAC ELEC. 35 L 39X44X20CM - POLY 1200D OR S/SIGLE
EP020417BMNON	SAC ELEC. 35L 39X44X20CM-POLY 1200 D BLEU M. S/SIGLE
EP020418ORNON	SAC ELEC. 45L ROUL. 41X55X25CM-POLY 1200 OR S/SIGLE
EP020418BMNON	SAC ELEC.45L ROULANT 41X55X25CM-POLY 1200 BM SS SIGLE

photos non contractuelles

BOUEE COURONNE

PLASTIMO

we
life

RÉF. ART.	DESCRIPTION
EP007193	Ø 75 CM EXTERIEUR Ø 45 CM INTERIEUR

GILET DE SAUVETAGE

PLASTIMO

we
life

RÉF. ART.	DESCRIPTION
EP008699	AUTO GONFLABLE
EP007562	GONFLAGE MANUEL

CARTOUCHE CO2 POUR GILET SAUVETAGE

PLASTIMO

we
life

RÉF. ART.	DESCRIPTION
EP007479	AUTO GONFLABLE

DETECTEUR MONO GAZ PORTABLE

MSA FRANCE

we
life

Détecteur MONO GAZ de haute performance et fiable pour l'CO.

RÉF. ART.	DESCRIPTION
EP005031	- ALTAIR CO
EP005032	- ALTAIR H2S
EP005033	- ALTAIR O2

DETECTEUR MULTI GAZ PORTABLE-

MSA FRANCE

we
life

Détecteur MULTI GAZ performant qui mesure les gaz O2, H2S, CO et les gaz explosibles. Boîtier caoutchouc robuste. Appareil étanche IP67. Equipé de l'alarme InstantAlert qui permet à l'utilisateur de déclencher manuellement une alarme en cas de danger.

RÉF. ART.	DESCRIPTION
EP018682	ALTAIR 4XR BLUETOOTH

NAPPE ISOLANTE 3/10MM**CATU**

RÉF. ART.	DESCRIPTION	REFERENCE FABRICANT
EP103820	12,50M	
EP103818	25,00M	
EP103819	1,3 x 25,00M	MP-35

photos non contractuelles

NAPPE ISOLANTE VELCRO



RÉF. ART.	DESCRIPTION
EP103805	0,36 X 0,66M
EP103806	0,5 X 0,9M
EP103807	0,8 X 1,2M

PINCE PLASTIQUE POUR NAPPE
COFFRET CCI

RÉF. ART.
EP103821

SAC ISOTHERME PORTE BOUTEILLE



RÉF. ART.	DESCRIPTION
EP004041	1.5L ORANGE

SACOCHE PORTE OUTILS



RÉF. ART.
EP103638

TAPIS ISOLANT 3MM



RÉF. ART.	DESCRIPTION
EP007799	0.60 M X 0.60 M
EP103822	0.60 X 1.00M
EP103802	1X5M

photos non contractuelles

TAPIS ISOLANT CEI CLASSE 0

RÉF. ART.	DESCRIPTION
EP103804	- 0,6M X 1M
EP103803	- 1M X 1M

TAPIS ISOLANT AVEC FRANGES EP

SIBILLE



RÉF. ART.	DESCRIPTION
OU105873	3MM 2X1M

SAC DE TRANSPORT POUR TAPIS ISOLANT

Spécialement étudié pour le transport et la protection des tapis isolants en modèle individuel. Longueur totale 70mm.

RÉF. ART.
EP007798

TUBE DE RANGEMENT POUR TAPIS

RÉF. ART.
EP103808

photos non contractuelles

TELEPHONE GSM PTI PROT.TRAVAILLEUR ISOLE

MAGNETA



Téléphone mobile GSM PTI - étanche IP56 à la poussière et eau - bouton SOS dédié - détection perte de verticalité ou absence de mouvement - jusqu'à 5 numéros d'appels d'urgence en cascade sécurisée - mode main libre activé sur appel en urgence - SMS d'alarme PTI personnalisable - fourni avec étui clip ceinture

RÉF. ART.	DESCRIPTION
EP010437	PREVOIR CARTE SIM

TRANSPORT EXPRESS

LE SERVICE TRANSPORT EXPRESS SUR MESURE VOUS ASSURE L'ENLÈVEMENT ET LA LIVRAISON DE COLIS, PLANS, PALETTES ET HORS-GABARIT DANS LES DÉLAIS LES PLUS COURTS.



RÉF. ART.	DESCRIPTION
Transport express	L.BONAVENTURE@bouygues-construction.com j.imboden@bouygues-construction.com

SUPPORT CERVICALES NECPROTECH

SUPPORT UTILISÉ POUR SOUTENIR LE POIDS DE LA TÊTE LORS DE TRAVAUX EN PLAFOND.



RÉF. ART.	DESCRIPTION
EP004137	Réduit considérablement les douleurs, tension et blessures de la nuque. Aide à prévenir l'usure de la colonne vertébrale, Poids : 480g, Hauteur réglable du support nuque

photos non contractuelles

ETHYLOTEST JETABLE



RÉF. ART.

EP005081

EMBOUT POUR ETHYLOTEST

PELIMEX



RÉF. ART.

DESCRIPTION

EP010637

PX PILOT

EP002125

REF CA2000 PX PRO GOLD

GARROT TOURNIQUET

ESCULAPE



Le garrot tourniquet est indiqué lorsque la compression directe est insuffisante inefficace ou impossible. Il permet de stopper le saignement des membres supérieurs (au bras) ou inférieurs (la cuisse). Fabricaiton 100% polypropylène avec bouclerie en aluminium. Peu emcombrant, léger, extrêmement résistant, il peut s'utiliser d'une seule main sans risque de desserrage. Longueur totale : 85 cm - Largeur du tissu 5 cm et 2,5 cm - Poids : 124 g -

RÉF. ART.

EP104693

TROUSSE DE SECOURS BY CN + DE 7 PERSONNES (composition 2021)

ESCULAPE



Contenu :

- 1 coffret ASEP GROS CHANTIERS - 2 couvertures de survie - 1 pince à échardes - 2 rouleaux de sparadrap 5 m x 2 cm - 1 paire de ciseaux Gesco - 40 compresses de gaze stériles 10 x 10 cm - 3 pochettes de froid instantané - 1 bande de pansement à découper 1 m x 6 cm - 1 coussin hémostatique - 2 sacs plastiques fermeture zippée - 5 paires de gants vinyle - 80 pansements adhésifs assortis 3 tailles - 10 unidoses de sérum physiologique - 1 boite de 5 mèches Coalgan - 1 tube d'hydrogel en

RÉF. ART.

EP111910

photos non contractuelles

TROUSSE DE SECOURS BY CN - DE 7 PERSONNES (composition 2021)

ESCULAPE



Contenu :

- 1 coffret ASEP CHANTIERS - 1 couverture de survie - 1 pince à échardes - 1 rouleaux de sparadrap 5 m x 2 cm - 1 paire de ciseaux Gesco
- 20 compresses de gaze stériles 10 x 10 cm - 2 pochettes de froid instantané - 1 bande de pansement à découper 1 m x 6 cm - 1 coussin hémostatique - 2 sacs plastiques fermeture zippée - 5 paires de gants vinyle - 40 pansements adhésifs assortis 3 tailles - 10 unidoses de sérum physiologique - 1 boîte de 5 mèches Coalgan - 1 tube d'hydrogel en 125 m

RÉF. ART.

EP111911

RECHERCHE TROUSSE DE SECOURS BY CN (composition 2021)

ESCULAPE



Contenu :

- 1 carton d'emballage - 1 rouleaux de sparadrap 5 m x 2 cm - 40 compresses de gaze stériles 10 x 10 cm - 2 pochettes de froid instantané - 5 paires de gants vinyle - 40 pansements adhésifs assortis 3 tailles - 10 unidoses de sérum physiologique - 1 vaporisateur 50 ml de chlorhexidine - 30 compresses antiseptiques chlorhexidine - 1 bande cohésive 4 m x 5 cm

RÉF. ART.

EP111912

TROUSSE DE SECOURS SAINT BERNARD BY CN (composition 2021)

ESCULAPE



Contenu :

- 1 coffret P28 - 1 couverture de survie - 10 compresses stériles 5 x 5 cm - 2 bandes extensibles 3 m x 7 cm - 1 coussin hémostatique - 1 sac plastique fermeture zippée - 2 paires de gants vinyle - 5 unidoses de chlorhexidine - 10 pansements auto adhésifs assortis 3 tailles - 1 vapo 50 ml de chlorhexidine

RÉF. ART.

EP111913

TROUSSE DE SECOURS 1 PERSONNE BY CN (COMPOSITION 2021)

ESCULAPE



Contenu :

- 1 Housse de rangement - 4 compresses stériles 20 x 20 cm - 4 compresses chlorhexidine - 2 unidoses de sérum physiologique - 2 bandes extensibles 3 m x 7 cm - 1 rouleau de sparadrap 5 m x 2 cm - 10 pansements assortis - 1 pince à échardes - 1 paire de gants vinyle - 1 paire de ciseaux

RÉF. ART.

EP112186

photos non contractuelles

TROUSSE DE SECOURS AUTO - GILET+ TRIANGLE BY CN (COMPOSITION 2021)

ESCALAPE



Contenu :

- 1 Housse de rangement - 1 triangle de présignalisation - 1 gilet jaune fluo dans sa housse - 1 trousse de secours Flotte Auto contenant : - 2 éthylotests à usage unique - 1 couverture de survie - 5 compresses stériles 5 x 5 cm - 1 rouleau de sparadrap 5 m x 2 cm - 4 bandes extensibles 3 m x 7 cm - 1 sachet de 10 pansements adhésifs assortis - 1 rouleau de sparadrap - 5 compresses chlorhexidine - 1 paire de ciseaux - 1 pince à échardes - 2 paires de gants vinyle - 1 guide de premie

RÉF. ART.

EP112187

KIT DE SAC POUR WC (BOITE DE 12 SACS)

ESCALAPE



we
life

KIT DE SAC POUR WC (BOITE DE 12 SACS)

RÉF. ART.

EP010081

KIT LAVE OEIL

ESCALAPE



we
life

LAVE CEIL 200ML - A UTILISER EN CAS DE POUSSIERE

RÉF. ART.	DESCRIPTION
EP005182	OPHTALMOLOGIQUE + POCLETTE
EP005183	PH NEUTRE + POCLETTE

KIT WC (AVEC 12 SACS ABSORBANT)

ESCALAPE



we
life

KIT WC (AVEC 12 SACS ABSORBANT) Système pliable et réutilisable de toilettes sèches jetables, portables et hygiéniques. Ce kit comprend : Une assise pliable qui se monte et se demonte en moins de 1mn. Elle permet de créer un caisson carton rigide (lunette de wc) résistant à un poids de plus de 115 kg pour l'assise de l'utilisateur. Livré avec 12 sacs absorbants oxo-dégradables qui viennent couvrir et protéger l'assise du caisson et intègrent un tampon super absorbant anti-odeur qui transforme en

RÉF. ART.
EP010080

POCHE A URINE - SACHET DE 20 POUCHES

ESCALAPE

we
life

RÉF. ART.

EP006027

POCHETTE FROID INSTANTANE

ESCALAPE

we
life

POCHETTE FROID INSTANTANE

RÉF. ART.

EP008618

TENTE DE CHANTIER

AXMATEL



RÉF. ART.

DESCRIPTION

EP103538

1,75X1,75X1,95M

photos non contractuelles

ARMOIRE A CLES

THIRARD



RÉF. ART.	DESCRIPTION
IN020615	POUR 20 CLÉS
IN020616	POUR 45 CLÉS
IN020617	POUR 93 CLÉS

PIQUET DE BOITE À LETTRE

DECAEUX



RÉF. ART.	DESCRIPTION
IN003555	

PORTE-CLÉS AVEC PORTE-ÉTIQUETTE



RÉF. ART.	DESCRIPTION
IN003696	_ SACHET DE 20

TAPIS ROUGE ECO

TAMMET



RÉF. ART.	DESCRIPTION
IN107753	15 KG, 12ML (EN ROULEAU)

BOITE À LETTRES 2 FACES

DECAEUX



RÉF. ART.	DESCRIPTION
IN000230	

CAILLEBOTIS CAOUTCHOUC NOIR



RÉF. ART.	DESCRIPTION
IN000445	M68 100X150CM

photos non contractuelles

COFFRET CORPS DE MÉTIERS IP44

Bals



Coffret équipés de 4 prises 220V, 1 disjoncteur 16A 30mA, 1 bouton d'arrêt d'urgence

RÉF. ART.	DESCRIPTION
IN001176	10/16A DPN

KIT COFFRET ÉCONOMISEUR D'EAU



RÉF. ART.	DESCRIPTION
IN005655	- NOUVEAU MODÈLE

POCHE À PLAN



RÉF. ART.	DESCRIPTION
IN007803	L.1500MM L.1000MM

TAPIS COCO



RÉF. ART.	DESCRIPTION
IN004218	L.60CM L.33CM EP.1,7CM

TRUELLE D'HONNEUR INOX À GRAVER

DÉLAI DE LIVRAISON À DÉFINIR EN FONCTION DES QUANTITÉS APRÈS VALIDATION DU BON À TIRER. PRÉVOIR GRAVURE IN008333 SANS LOGO OU IN008666 AVEC LOGO



RÉF. ART.	DESCRIPTION
IN004533	

GRAVURE

DÉLAI DE LIVRAISON À DÉFINIR EN FONCTION DES QUANTITÉS APRÈS VALIDATION DU BON À TIRER.



RÉF. ART.	DESCRIPTION
IN008666	AVEC LOGO SUR TRUELLE IN004533
IN008333	TEXTE SUR TRUELLE IN004533

photos non contractuelles

TUBE PARCHEMIN CUIVRE



AGRAFEUSE T50

RÉF. ART.

IN005843

TRANSPORT EXPRESS

LE SERVICE TRANSPORT EXPRESS SUR MESURE VOUS ASSURE

L'ENLÈVEMENT ET LA LIVRAISON DE COLIS, PLANS, PALETTES ET HORS-GABARIT DANS LES DÉLAIS LES PLUS COURTS.



RÉF. ART.

DESCRIPTION

L.BONAVENTURE@bouygues-construction.com

Transport express

j.imboden@bouygues-construction.com

BYTROC

APP INTERNE BYCN



Flashez le QR code pour découvrir en détail le service ou bien : <https://bycnmateriel.odoo.com/montage-mobilier>

RÉF. ART.

DESCRIPTION

BYTROC

Annonces de recherche, vente et/ou troc de matériel, matériaux et équipements dont les chantiers BYCN n'ont plus l'utilité.

VALDELIA

ECO ORGANISME VALDELIA



Flashez le QR code pour découvrir en détail le service ou bien : <https://bycnmateriel.odoo.com/montage-mobilier>

RÉF. ART.

DESCRIPTION

VALDELIA

Le mobilier de chantier peut être gratuitement récupéré pour dons, vente ou recyclage.

photos non contractuelles

AGRAFES POUR T50

VINMER



AGRAFEUSE T50

RÉF. ART.	DESCRIPTION
IN000053	AGRAFES 10MM POUR T50
IN000054	AGRAFES 14MM POUR T50

AGRAFEUSE

VINMER



RÉF. ART.	DESCRIPTION
IN000055	ÉLECTRIQUE
IN000056	MANUELLE T50 - 63632

BÂCHE AVEC OEILLETS EN POLYÉTHYLÈNE

BACHE 150G / M²



RÉF. ART.	LONGUEUR	LARGEUR
IN005690	L 12 M	1 8 M
IN005692	L 15 M	1 10 M
IN005689	L 8 M	1 5 M
IN005688	L 5 M	1 4 M

COUPE CANULE SECUMAX RAPID 594

MARTOR



Outil permettant l'ouverture des cartouches de silicone et la découpe de la

douille

RÉF. ART.
IN009177

photos non contractuelles

COUPEAU À LAME AUTO-RÉTRACTABLE IRWIN



RÉF. ART.
IN007055

COUPEAU COUPE FILM EN PLASTIQUE

MARTOR



COUPE FILM EN PLASTIQUE. LAME NON INTERCHANGEABLE, INJECTÉE AVEC TRANCHANT PROTÉGÉ

RÉF. ART.	DESCRIPTION
IN001745	POLYCUT 8500
IN001746	POLYCUT N°469

COUPEAU COUPE FILM ET MOUSSE

MARTOR



COUPE FILM ET MOUSSE. PATIN PORTE LAME EN METAL TEFLONISE PERMETTANT LA COUPE DES PLAQUES SYNTHÉTIQUES ÉPAISSES. PATIN INVERSE POUR COUPE TIRANT

RÉF. ART.	DESCRIPTION
IN001747	OPTICUT N°436

COUPEAU DE SÉCURITÉ À LAME PROTÉGÉE POUR COUPE EMBALLAGE

MURE & PEYROT



COUPEAU DE SECURITE BORDEAUX A LAME PROTEGEE POUR COUPE EMBALLAGE

RÉF. ART.
IN001748

COUTEAU DE SÉCURITÉ GEMEL, SORITE DE LAME JUSQU'À 20MM

MURE & PEYROT



we life

COUTEAU DE SECURITE AMBIDEXTRE A LAME RETRACTABLE ET INTERIEUR EN METAL. SPECIAL POUR CARTONS. SORTIE DE LAME JUSQU'À 20MM

RÉF. ART.

IN001749

COUTEAU DE SÉCURITÉ MEGASAFE, DÉBORD DE LAME 27MM

MARTOR



we life

Débord de la lame de 27mm - validé BYEFE

RÉF. ART.

IN009969

COUTEAU DE SÉCURITÉ SECUMAX 350

MARTOR



we life

POUR CARTON, PLASTIQUE, SCOTCH

RÉF. ART.

IN001750

COUTEAU DE SÉCURITÉ SECUPRO 625

MARTOR



COUTEAU SECUMAX 350

RÉF. ART.

IN018482

photos non contractuelles

LAME DOUBLE POUR CUTTER DE SECURITÉ IN001750

MARTOR



AC1647A

RÉF. ART.

IN002621

LAME POUR COUTEAU COUPE-FILM ET MOUSSE OPTICUT N°436

MARTOR



COUTEAU BORDEAUX

LAME POUR COUPE FILM ET MOUSSE

RÉF. ART.

IN002625

LAME POUR COUTEAU AUTO-RÉTRACTABLE IRWIN



COUTEAU OPTICUT 436

RÉF. ART.

IN007056

LAME POUR COUTEAU DE SÉCURITÉ BORDEAUX IN001748

MURE & PEYROT



COUTEAU SECUMAX RAPID 594

RÉF. ART.

IN002626

photos non contractuelles

LAME POUR SECUMAX RAPID

MARTOR

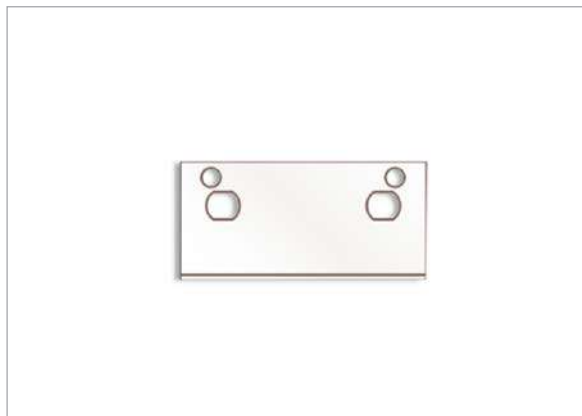

COUTEAU GEMEL
Lame pour coupe canule SECUMAX

RÉF. ART.
IN009178

LAMES POUR COUTEAU DE SÉCURITÉ GEMEL

MURE & PEYROT



COUTEAU MEGASAFE 99
LAME POUR COUTEAU DE SECURITE AMBIDEXTRE A LAME RETRACTABLE ET INTERIEUR EN METAL. SPECIAL POUR CARTONS. SORTIE DE LAME JUSQU'À 20MM

RÉF. ART. DESCRIPTION
IN002627 - 10 LAMES

LAMES POUR COUTEAU MEGASAFE

MARTOR

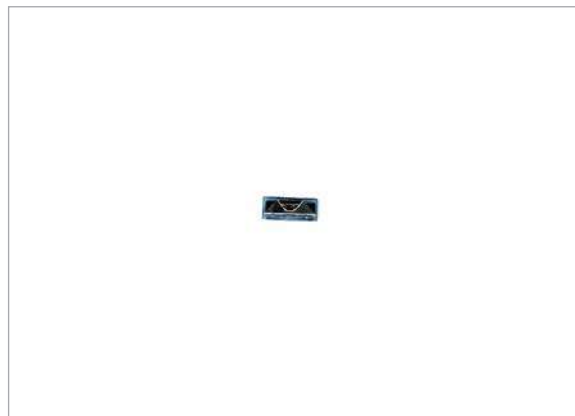

RÉF. ART. DESCRIPTION
IN009971 N°99 - BOITE DE 10

CARTON DE DÉMÉNAGEMENT

CARTON DE DEMENAGEMENT 60 X 50 X 40CM (VENDUS PAR COLIS DE 25)



RÉF. ART. DESCRIPTION
IN007403 60 X 50 X 40CM

PAPIER KRAFT



RÉF. ART. DESCRIPTION
IN007432 L.400M 72G

photos non contractuelles

FILM BULLES

POUR PROTECTION ET EMBALLAGE



RÉF. ART.	LONGUEUR	LARGEUR
IN007121	L 25 M	I 100 CM

ROULEAU CARTON ONDULÉ

RÉF. ART.	DESCRIPTION	LONGUEUR	LARGEUR
IN007430	L.50M L.140CM	L 50 M	I 140 CM

VERIFIEZ LA DISPONIBILITE DE NOS PRODUITS

DISTRIMO



En scannant le QR code, vérifiez le stock des produits à l'aide des références et de la barre de recherche

RÉF. ART.	DESCRIPTION
SITE WEB	http://distrimo.bouygues-construction.com/

photos non contractuelles

CORDAGE POLYPROPYLÈNE COURONNE

CORDAGE POLYPROPYLENE



RÉF. ART.	DESCRIPTION	DIAMETRE
IN001465	CORDAGE POLYPROPYLÈNE COURONNE DE 100ML	D 10 MM
IN001466		D 12 MM

CORDAGE POLYPROPYLÈNE

CORDAGE PP Ø 08 ORANGE LONGUEUR 5 METRES AVEC BOUCLES SANS COSSES



RÉF. ART.	DESCRIPTION	COULEUR	DIAMETRE
IN017083	D.8MM L.5M	ORANGE	D 8 MM

CORDAGE POLYPROPYLÈNE COURONNE

CORDAGE POLYPROPYLENE



RÉF. ART.	DESCRIPTION	DIAMETRE
IN001467	DE 100ML	D 14 MM
IN001468	DE 50ML	D 14 MM
IN005694	DE 100ML	D 16 MM
IN001469	DE 50ML	D 16 MM
IN001463	DE 100ML	D 6 MM

CORDAGE POLYPROPYLÈNE COURONNE

CORDAGE POLYPROPYLENE



RÉF. ART.	DESCRIPTION	DIAMETRE
IN001464	DE 100ML	D 8 MM

CORDE À POULIE AVEC CROCHET



RÉF. ART.	DESCRIPTION	DIAMETRE
IN001473	L.30ML	D 20 MM
IN001474	L.40ML	D 20 MM
IN001475	L.50ML	D 20 MM
IN001472	L.20ML	D 22 MM

photos non contractuelles

POULISTOP

RÉF. ART.	DESCRIPTION
IN003732	150KG

DÉVIDOIR DE FEUILLARD POLYESTER

RÉF. ART.	DESCRIPTION
IN001807	

BOUCLE EN MÉTAL

RÉF. ART.	DESCRIPTION
IN000267	CB6 L.19MM
IN000268	PHOSPHATÉ CB6F L.19MM

FEUILLARD POLYESTER COMPOSITE

RÉF. ART.	DESCRIPTION
IN002233	60WGHM (SOUPLE)
IN002234	CC60 (RIGIDE)

**CISAILLE DE SÉCURITÉ SUPER TYMER
POUR FEUILLARD ACIER**

VALIDATION SECURITE LISTE BYEFE



RÉF. ART.	DESCRIPTION
IN000898	

TENDEUR POUR FEUILLARD POLYESTER

RÉF. ART.	DESCRIPTION
IN004243	TENDEUR MANUEL CT20 POUR FEUILLARD POLYESTER

photos non contractuelles

ARMOIRE BASSE 2 CASES À RIDEAUX VERTICAUX,

MOBIKA



RÉF. ART.	DESCRIPTION	EPAISSEUR
IN000101	BEIGE	H 105 CM

ARMOIRE BASSE PORTES BATTANTES

MOBIKA



RÉF. ART.	DESCRIPTION	EPAISSEUR
IN000102		H 100 CM
IN010768	, GRISE	

ARMOIRE BASSE A RIDEAUX VERT 2 CASES GRISE

MOBIKA



RÉF. ART.	DESCRIPTION
IN008432	L.105x100x40

ARMOIRE BUREAU 4 ÉTAGÈRES

MOBIKA



RÉF. ART.	DESCRIPTION
IN008640	BEIGE
IN010769	GRISE

photos non contractuelles

ARMOIRE HAUTE PORTES BATTANTES

MOBIKA

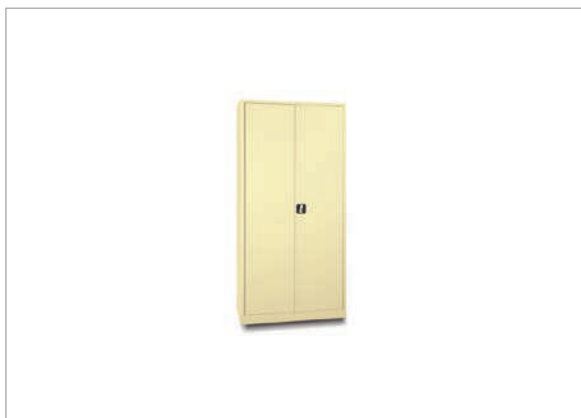

RÉF. ART.	DESCRIPTION	EPAISSEUR
IN000104		H 195 CM
IN010770	- 195x92x42 GRISE	

ARMOIRE HAUTE À RIDEAUX VERTICAUX,

MOBIKA



RÉF. ART.	DESCRIPTION	EPAISSEUR
IN000103	ARMOIRE HAUTE À RIDEAUX VERTICAUX BEIGE	H 180 CM
IN008434	ARMOIRE HAUTE À RIDEAUX VERTICAUX GRISE	

ARMOIRE HAUTE À RIDEAUX VERTICAUX

MOBIKA



RÉF. ART.	DESCRIPTION
IN010771	L. 190x120x40 BEIGE
IN010772	L. 190x120x40 GRISE

SOCLE BANC POUR VESTIAIRE INDUSTRIE PROPRE

MOBIKA

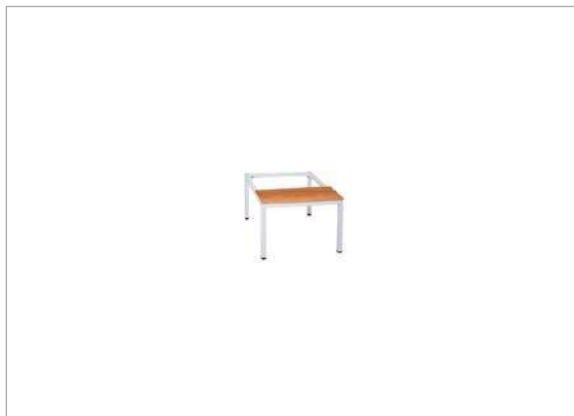

RÉF. ART.	DESCRIPTION
CO004121	L.600MM

photos non contractuelles

SOCLE BANC POUR VESTIAIRE INDUSTRIE SALISSANTE

MOBIKA



RÉF. ART.	DESCRIPTION
CO004123	L.800MM
CO004122	SOCLE BANC POUR VESTIAIRE INDUSTRIE SALISSANTE L.1200MM

BANC EMPILABLE

MOBIKA



RÉF. ART.	DESCRIPTION
IN000199	L.1,6M
IN010773	L.2ML

BUREAU SÉRIE U

MOBIKA



RÉF. ART.	DESCRIPTION
IN010780	EN HÊTRE DROITE PIEDS L.160CM, ANGLE 90°
IN010781	EN HÊTRE GAUCHE PIEDS L.160CM, ANGLE 90°
IN010779	EN MÉLAMINE HÊTRE PIEDS ALUMINIUM L.160CM

CAISSON HAUTEUR DE BUREAU 3 TIROIRS

MOBIKA

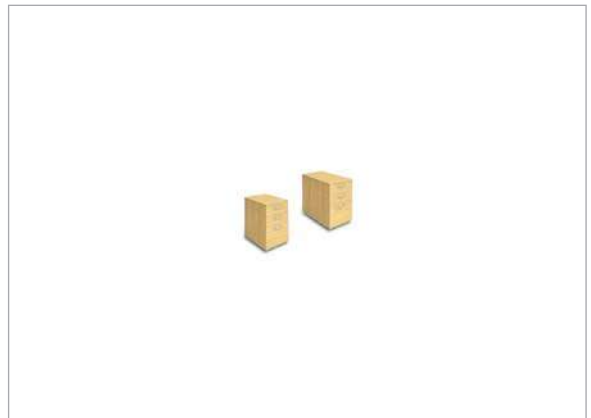

RÉF. ART.	DESCRIPTION
IN010778	EN BOIS HÊTRE

photos non contractuelles

CAISSON MOBILE 2 TIROIRS

MOBIKA



RÉF. ART.	DESCRIPTION
IN010776	EN BOIS HÊTRE

CAISSON MOBILE 3 TIROIRS

MOBIKA



RÉF. ART.	DESCRIPTION
IN010775	EN BOIS HÊTRE
IN010777	EN MÉTAL GRIS

CHAISE COQUILLE EN PLASTIQUE

MOBIKA



RÉF. ART.	DESCRIPTION
IN008437	ANTHRACITE AVEC PIÈTEMENT NOIR
IN008442	
IN008438	BEIGE AVEC PIÈTEMENT NOIR
IN008439	BLEU AVEC PIÈTEMENT NOIR
IN000511	MARRON AVEC PIÈTEMENT NOIR
IN008440	NOIR AVEC PIÈTEMENT NOIR
IN008441	ROUGE AVEC PIÈTEMENT NOIR

CHAISE DACTYLO AVEC ACCOUDOIRS

MOBIKA



RÉF. ART.	DESCRIPTION
IN000512	, DOSSIER EN TISSU

CHAISE DE VISITEUR

MOBIKA



RÉF. ART.	DESCRIPTION
IN000515	STRUCTURÉ AVEC ACCOUDOIRS
IN000516	STRUCTURÉ HETRE MULTIPLIS
IN000514	, ASSISE ET DOSSIER EN PU, 4 PIEDS PEINTS

PIÈCE DE LIAISON MÉTALLIQUE POUR CHAISE DE VISITEUR

MOBIKA



RÉF. ART.	DESCRIPTION
IN003481	

CHAISE PLIANTE EN PVC

MOBIKA



RÉF. ART.	DESCRIPTION
IN000513	REVÊTUE, PIEDS LAQUÉS EN NOIR

CORBEILLE À PAPIER 1/2 LUNE

MOBIKA



CORBEILLE A PAPIER 1/2 LUNE 15 LITRES PLASTIQUE NOIR AVEC SYSTEME DE CLIPSAGE

RÉF. ART.	DESCRIPTION
IN010774	15L AVEC CLIPSAGE, NOIR

photos non contractuelles

CORBEILLE TRI-SÉLECTIF

MOBIKA



RÉF. ART.	DESCRIPTION
IN001460	NON IGNIFUGE 20L

ÉLÉMENT SUIVANT D'ARCHIVES

MOBIKA



RÉF. ART.	DESCRIPTION
IN002098	L.198CM L.130CM, 6 ÉTAGÈRES

ÉLÉMENT DE DÉPART D'ARCHIVES

MOBIKA



RÉF. ART.	DESCRIPTION
IN002095	L.198CM L.130CM, 6 ÉTAGÈRES

ETAGERE POUR RAYONNAGE MÉTALLIQUE

MOBIKA



RÉF. ART.	DESCRIPTION
IN002193	L.100CM L.30CM

FAUTEUIL DE DIRECTION BASCULANT

MOBIKA



RÉF. ART.	DESCRIPTION
IN002226	EN TISSU NOIR

LAMPE DE BUREAU INCLINABLE

MOBIKA



RÉF. ART.	DESCRIPTION
IN002681	SUR SOCLE

FAUTEUIL DE DOSSIER RÉSILLE

MOBIKA



RÉF. ART.	DESCRIPTION
IN002227	EN TISSU ACCOUDOIRS ET ROULETTE

MANGE-DEBOUT SIMPLE À PLATEAU

MOBIKA



RÉF. ART.	DESCRIPTION
IN002830	HÊTRE ET PIÈTEMENT CHROMÉ

photos non contractuelles

MEUBLE POUR COIN DE CUISINE

MOBIKA



RÉF. ART.	DESCRIPTION
IN010782	L.1000CM P.560CM

PATÈRE MÉTALLIQUE EN EPOXY

MOBIKA



RÉF. ART.	DESCRIPTION
IN003416	BLANC À 1 TÊTE
IN003417	BLANC À 2 TÊTES
IN003418	BLANC À 3 TÊTES

PATÈRE

MOBIKA



RÉF. ART.	DESCRIPTION
IN003414	À TROIS TÊTES L.42CM
IN003415	AIMANTÉE À UNE TÊTE

PORTE-MANTEAU ET PORTE-PARAPLUIES

MOBIKA

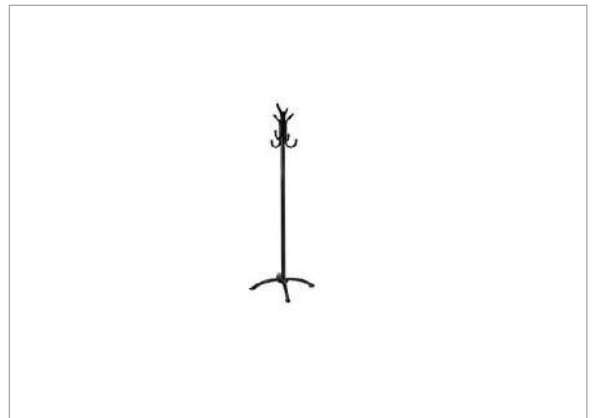

RÉF. ART.	DESCRIPTION
IN003699	, 8 TÊTES NOIR

TABLE 1/2 LUNE

MOBIKA



RÉF. ART.	DESCRIPTION
IN004178	140X70 HETRE CADRE+PIED METAL CARRE NOIR 19MM

TABLE DE REUNION

MOBIKA



RÉF. ART.	DESCRIPTION
IN004176	DIA.120 HETRE PIETEMENT NOIR

TABLE 180X75

MOBIKA



RÉF. ART.	DESCRIPTION
IN004175	CADRE ET PIEDS CARRE NOIR 19MM

TABLE MODULAIRE HETRE

MOBIKA



RÉF. ART.	DESCRIPTION
IN004179	TABLE MODULAIRE 140X70 HETRE CADRE ET PIEDS CARRES NOIR 19MM
IN004180	TABLE MODULAIRE 160X75X19 HETRE CADRE+PIEDS CARRE NOIR 19MM

photos non contractuelles

TABLE PLIANTE

MOBIKA



RÉF. ART.	DESCRIPTION
IN004181	160X80 BEIGE

VENTILATEUR COLONNE



RÉF. ART.	DESCRIPTION
IN005903	L.800MM L.227MM

VENTILATEUR DE TABLE



RÉF. ART.	DESCRIPTION
IN004581	HÉLICE D.300MM

VENTILATEUR SUR PIED TÉLÉSCOPIQUE



RÉF. ART.	DESCRIPTION
CO005902	HÉLICE D.300MM

VESTIAIRE INDUSTRIE PROPRE SANS PIED

MOBIKA



RÉF. ART.	DESCRIPTION
IN004595	1 CASE SANS PIED L.300x500x1800MM
IN004596	2 CASES SANS PIED L.600x500x1800
IN004597	3 CASES SANS PIED L.900x500x1800

photos non contractuelles

VESTIAIRE INDUSTRIE SALISSANTE SANS PIED

MOBIKA



RÉF. ART.	DESCRIPTION
IN004592	1 CASE SANS PIED L.400MM
IN004593	2 CASES SANS PIED L.800MM
IN004594	3 CASES SANS PIED L.1200MM

SERRURE À MORAILLON

MOBIKA



RÉF. ART.	DESCRIPTION
IN004099	SANS CLÉ POUR VESTIAIRE

CANON COFFRE FORT POUR COLONNE

MOBIKA

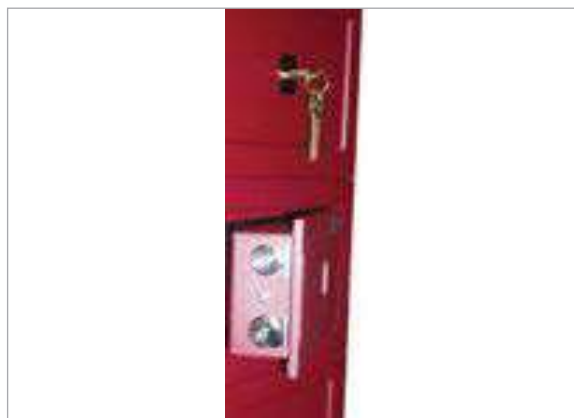

RÉF. ART.	DESCRIPTION
IN020631	CANON COFFRE FORT AR-SCF-001 POUR COLONNE

BYTROC

APP INTERNE BYCN



Flashez le QR code pour découvrir en détail le service ou bien : <https://bycnmateriel.odoo.com/montage-mobilier>

RÉF. ART.	DESCRIPTION
BYTROC	Annonces de recherche, vente et/ou troc de matériel, matériaux et équipements dont les chantiers BYCN n'ont plus l'utilité.

photos non contractuelles

ALLUME FEU

ALLUME FEU GEL BIDON 1 LITRE POUR ALLUMAGE BARBECUES



RÉF. ART.	DESCRIPTION
IN005631	EN GEL BIDON 1L

CHARBON DE BOIS

LIVRAISON UNIQUEMENT EN IDF



RÉF. ART.	DESCRIPTION
IN000520	8KG

GOBELET BIODEGRADABLE



RÉF. ART.	DESCRIPTION
IN018410	18CL LOVE NATURE - LE CENT

photos non contractuelles

CAFETIÈRE ÉLECTRIQUE



RÉF. ART.	DESCRIPTION
IN000442	10 À 12 TASSES

CAFETIÈRE À DOSETTES SENSEO

PHILIPS



RÉF. ART.	DESCRIPTION
IN100372	CAFETIÈRE PHILIPS À DOSETTES SENSEO

CHAUFFE-GAMELLES

MOBIKA



RÉF. ART.	DESCRIPTION	PUISSANCE
IN000545	1100 W, CAPACITÉ DE 20-30 PERSONNES	Pu 1100 W
IN000546	2200 W, CAPACITÉ DE 40-50 PERSONNES	Pu 2200 W
IN000547	500 W, CAPACITÉ DE 10-12 PERSONNES	Pu 500 W

GLACIERE ET RECHAUD

MAKITA



RÉF. ART.	DESCRIPTION	REFERENCE FABRICANT
IN106716	18V Li-ION 20 L (PRODUIT SEUL)	DCW180Z

AUTOCOLLANT CHAUFFE-GAMELLES CHSCT



RÉF. ART.
SI006029

ROULEAU DE PAPIER ALUMINIUM



RÉF. ART.	DESCRIPTION
IN007182	L.50M

photos non contractuelles

FOUR À MICRO-ONDE

MOBIKA



RÉF. ART.	DESCRIPTION
IN002328	900W 25L

RÉFRIGÉRATEUR TABLE TOP

MOBIKA



RÉF. ART.
IN003884

GLACIERE ELECTRIQUE RIGIDE



RÉF. ART.	DESCRIPTION
IN950002	25L ALLUME CIGARE + SECTEUR

CONVECTEUR MURAL

ATLANTIC



RÉF. ART.	DESCRIPTION	PUISSANCE
IN007510	F17/3 BLANC	Pu 2000 W
IN007509	F617	Pu 1500 W

RECHAUD ÉLECTRIQUE

MOBIKA



Emaillé blanc

RÉF. ART.	DESCRIPTION	PUISSANCE
IN003871	2 PLAQUES 2500W	Pu 2500 W

photos non contractuelles

CONVECTEUR SUR PIED

MOBIKA



RÉF. ART.	DESCRIPTION	PUISSANCE
IN001442	1200/2000W, GRIS CLAIR	Pu 2000 W

CHAUFFAGE AIR CHAUD C3



RÉF. ART.	DESCRIPTION
IN017852	220V MONO CABLE 1.5ML

VALDELIA

ECO ORGANISME VALDELIA



Flashez le QR code pour découvrir en détail le service ou bien : <https://bycnmateriel.odoo.com/montage-mobilier>

RÉF. ART.	DESCRIPTION
VALDELIA	Le mobilier de chantier peut être gratuitement récupéré pour dons, vente ou recyclage.

VERIFIEZ LA DISPONIBILITE DE NOS PRODUITS

DISTRIMO



En scannant le QR code, vérifiez le stock des produits à l'aide des références et de la barre de recherche

RÉF. ART.	DESCRIPTION
SITE WEB	http://distrimo.bouygues-construction.com/

photos non contractuelles

CADENAS À CHIFFRES

THIRARD



RÉF. ART.	DESCRIPTION	LARGEUR
IN000425	L.40MM	140 MM
IN000426	L.50MM	150 MM

CADENAS, QUALITÉ ORDINAIRE

THIRARD



RÉF. ART.	LARGEUR
IN000429	135 MM
IN000432	145 MM
IN000434	150 MM
IN000437	160 MM

CADENAS CONTAINER

THIRARD



RÉF. ART.	DESCRIPTION	LARGEUR
IN000428	L.92MM	192 MM

CADENAS, QUALITÉ SUPÉRIEURE

THIRARD



RÉF. ART.	LARGEUR
IN000430	135 MM
IN000433	145 MM
IN000435	150 MM
IN000438	160 MM

CADENAS EN MODE S'ENTROUVRANT

THIRARD



RÉF. ART.	DESCRIPTION	LARGEUR
IN000436	L.50MM	150 MM
IN000439	L.60MM	160 MM
IN000431	, QUALITÉ SUPÉRIEURE L.40MM	140 MM

photos non contractuelles

CHAÎNE MÉTALLIQUE GALVANISÉE

THIRARD



RÉF. ART.	DIAMETRE
IN000505	D 4 MM
IN000506	D 6 MM
IN006028	D 8 M

CORNE DE BRUME



RÉF. ART.	DESCRIPTION
IN005684	À CARTOUCHE DE GAZ INFLAMMABLE

CARTOUCHE DE GAZ ININFLAMMABLE POUR CORNE DE BRUME



RÉF. ART.	DESCRIPTION
CO005683	AS2008

VERROU À BOUTON, CYNLINDRE

THIRARD



RÉF. ART.	DESCRIPTION	LONGUEUR	DIAMETRE
IN004584	60MM S'ENTROUVRANT, 3 CLÉS	L 25 MM	D 2,7 MM
IN004583	60MM, 3 CLÉS		

CYLINDRE

THIRARD



RÉF. ART.	DESCRIPTION	LONGUEUR	LARGEUR
IN001784	ÉCO L.30MM L.30MM, 30L	L 30 MM	I 30 MM
IN018339	EN LAITON HG5 PROFILÉ À BOUTON L.30MM L.30MM		
IN001780	L.30MM L.30MM S'ENTROUVANT EUROPE LAITON	L 30 MM	I 30 MM
IN001782	L.40MM L.30MM	L 40 MM	I 30 MM

photos non contractuelles

DENEIGEANT

DACD



AVEC INHIBITEUR CORROSION

RÉF. ART.	DESCRIPTION
IN001797	ELINEIGE PAILLETTE SEAU DE 30L

SEL DE DÉNEIGEMENT

LIVRAISON UNIQUEMENT EN IDF



RÉF. ART.	DESCRIPTION
IN005633	EN SAC 25 KG

photos non contractuelles

BIDON ADBLEU

ITEX



RÉF. ART.	DESCRIPTION	TAILLE
IN017920	10L	10 LITRES

LAVE GLACE

ITEX



RÉF. ART.	DESCRIPTION
IN002702	BIDON DE 5L

DISQUE DE STATIONNEMENT CARTONNÉ



RÉF. ART.
SI010812

COFFRET BERLINGO/JUMPER

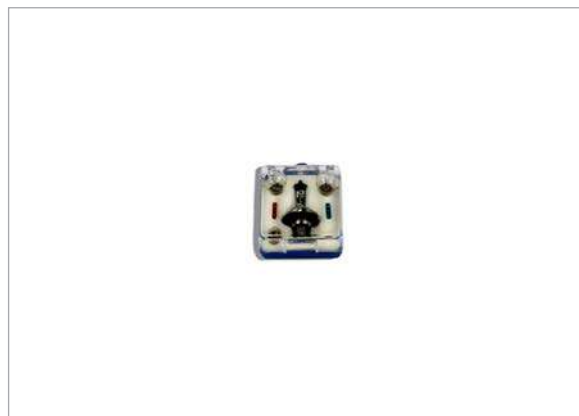

RÉF. ART.	DESCRIPTION
IN001188	H4

EXTINCTEUR



RÉF. ART.	DESCRIPTION
IN005686	1KG

COFFRET CLIO



RÉF. ART.	DESCRIPTION
IN001189	H7 CLIO/206

photos non contractuelles

BLOC MULTIPRISE



RÉF. ART.	DESCRIPTION
IN000222	5 PRISES AVEC CÂBLE L.1,4M
IN007869	ÉTANCHE 4 PRISES POIGN TRANSP + INTERRUPTEUR

RALLONGE



RÉF. ART.	DESCRIPTION	LONGUEUR
IN003849	220V L.5M 3x1.5+T	L 5 M
IN005596	3X2.5² 220V L.25ML	L 25 M
IN005595	4X2.5² 16A L.25ML	
IN005594	5X6² 32A L.12ML	
IN005597	5X6² 32A L.25ML	
IN005593	5X6² 32A L.6ML	

ENROULEUR



RÉF. ART.	DESCRIPTION	LONGUEUR
IN002153	4 PRISES BAT-PRO L.25M	L 25 M
IN002155	CABLE 25 ML - 3 X 2.5 AVEC DISJONCT THERM - IP 44	L 25 M

MULTIPRISE AVEC INTERRUPTEUR

LEGRAND



RÉF. ART.	DESCRIPTION
IN007867	AVEC CÂBLE L.3M, 6 PRISES

photos non contractuelles

MOTOPOMPE PAC-PSP3-5 CABLE 5M



MOTEUR ESSENCE GX160 + CREPINE

RÉF. ART.	DESCRIPTION
IN103847	HONDALEMENT 75MM

TUYAU DE REFOULEMENT PLAT



Pour motopompe

RÉF. ART.	DESCRIPTION
IN103605	TUYAU REFOULEMENT PLAT DN76 5?5 BARS COURONNE 25ML

POMPE D'ÉPUISEMENT



RÉF. ART.	DESCRIPTION
IN005329	POUR EAUX CHARGÉES ET CLAIRES;220V 225L/MN SORTIE Ø50MM
IN005330	POMPE ÉPUISEMENT AUTOMATIQUE 220V 225L/MN SORTIE Ø50MM

TUYAU DE REFOULEMENT PLAT

POUR POMPE D'ÉPUISEMENT



RÉF. ART.	DESCRIPTION
CO004566	D.50MM

POMPE ROTATIVE



RÉF. ART.	DESCRIPTION	DIAMETRE
IN007115	35L/MN - FLEXIBLE 2M ET BEC VERSEUR	D 50 MM

photos non contractuelles

POMPE SEMI-ROTATIVE



DEBIT DE 1,3 0 3 M3 HEURE

RÉF. ART.	DESCRIPTION
IN003685	JAPY DEBIT 1,3M 3/H

TUYAU DE REFOULEMENT PLAT



RÉF. ART.	DESCRIPTION
CO004565	D.25MM COURONNE DE 25ML

POMPE SERPILLIÈRE



POMPE POUR EAU CLAIRE

RÉF. ART.	DESCRIPTION
IN005331	230V 170L/MN

photos non contractuelles

BALADEUSE DE CHANTIER



RÉF. ART.	DESCRIPTION
IN000188	220V jusqu'à épauisement

COFFRET 6 BALISES LED RECHARGEABLES



RÉF. ART.
IN010600

BALADEUSE DE CHANTIER LED



RÉF. ART.
IN106175

GUIRLANDE RUBAN LED

GUIRLANDE RUBAN LED LED 230V IP44 - LONGUEUR 10ML AVEC CONNECTEURS MALE/FEM - PREVOIR ALIMENTATION IN010665 (SANS FICHE) POUR RACCORDEMENT A UNE BOITE DE DERIVATION OU ALIMENTATION IN010881 (AVEC FICHE) POUR BRANCHEMENT SUR PRISE MURALE OU RALLONGE.



RÉF. ART.	DESCRIPTION	PUISSANCE
IN010664	230V IP44 L.10ML AVC CONN. MALE/FEM	Pu 8,5 W

BLOC SECOURS LED



RÉF. ART.	DESCRIPTION
IN010872	IP65 2W AVEC 1ML CABLE RO2V 3G1,5 RACCORDE

photos non contractuelles

GYROPHARE STANDARD MAGNÉTIQUE

AVEC FOND AIMANTÉ ET VENTOUSE + TOIT VITRÉ - FOURNI AVEC AMPOULES



RÉF. ART.	DESCRIPTION
IN002419	12-24V

KIT RUBAN LED

AVEC ALIM + EMBOUTS

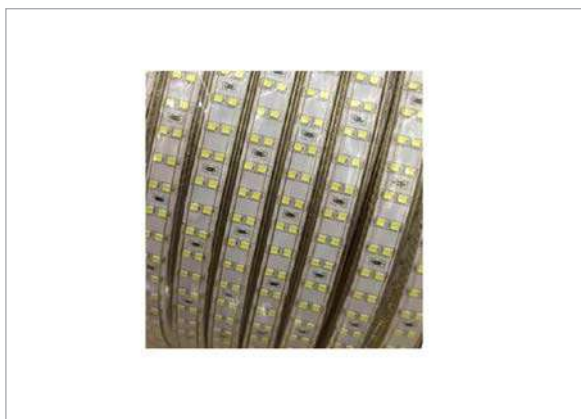

RÉF. ART.	DESCRIPTION
IN018533	50ML 144 LED/ML IP65 220V 3000°K

ALIMENTATION POUR RUBAN LED

ALIMENTATION POUR RUBAN LED 8ML AVEC CONNECTEURS MÂLE/FEMELLE ET BOUCHON - LIVRE AVEC FICHE POUR BRANCHEMENT SUR PRISE



RÉF. ART.	DESCRIPTION
IN010881	AVEC FICHE L.8ML
IN010665	SANS FICHE L.8ML

LAMPE PORTO LED

VARTA



RÉF. ART.	DESCRIPTION	PUISSANCE
IN002686	3W COMPLÈTE AVEC PILE PVC	Pu 3 W

LAMPE TORCHE



RÉF. ART.	DESCRIPTION	PUISSANCE
IN002689	LED LENSER T7 LAMPE 3W	Pu 3 W
IN002690	TYPE MAG-LITE	
IN020750	BALADEUSE LED MULTI USAGE	

PHARE RECHARGEABLE ENERGIZER



RÉF. ART.	DESCRIPTION
IN003465	AVEC CHARGEUR POUR 220V

photos non contractuelles

POT À LEDS INCASSABLE 230V

POT A LEDS INCASSABLE MBERG 230V PRISE FRANCAISE CABLE 5ML BLEU LOGO DISTRI

PERMET D'ÉCLAIRE UNE ZONE D'ENVIRON 12M² POUR 200 LUX



RÉF. ART.	DESCRIPTION	PUISSANCE
IN010642	+ CÂBLE BLEU L.5ML	Pu 24 W

PROJECTEUR LED 20W

PROJECTEUR LED 20W ORANGE BOUYGUES DISTRIMO SUR BATTERIE RECHARGEABLE PERMET D'ÉCLAIRE UNE ZONE D'ENVIRON 9M² POUR 200 LUX



RÉF. ART.	DESCRIPTION	COULEUR	PUISSANCE
IN010911	ORANGE SUR BATTERIE RECHARGEABLE	ORANGE	Pu 20 W

PROJECTEUR LED 30W A DETECTEUR DE MOUVEMENT



RÉF. ART.
IN018156

REGLETTE LED 40W SUR TREPIED JAUNE

SICOM



RÉF. ART.
IN005898

PROJECTEUR LED 30W PORTABLE



RÉF. ART. DESCRIPTION
IN017310 PROJECTEUR LED 30W PORTABLE

photos non contractuelles

PROJECTEUR LED 50W

LEXIE



RÉF. ART.	DESCRIPTION
IN017017	220V PORTABLE
IN018701	SUR PIED TELESCOPIQUE

PERCHE TREPIED TELESCOPIQUE 5ML



RÉF. ART.	DESCRIPTION
IN017158	POUR BALLON ECLAIRANT

BALLON ECLAIRANT LED



RÉF. ART.	DESCRIPTION
IN017157	SIROCCO 2M 6X100W LED AUTOGONFLANT 6000°K

RÉGLETTÉ ÉTANCHÉ AVEC TUBE



RÉF. ART.	DESCRIPTION	LONGUEUR	PUISSANCE
IN003891	36W L.120CM + CÂBLE	L 120 CM	Pu 36 W

ENVELOPPE BALLON ECLAIRANT

RÉF. ART.	DESCRIPTION
IN017160	SEULE POUR SIROCCO 2M MARQUAGE BY MATERIEL

photos non contractuelles

AMPOULE ECO 15W



RÉF. ART.	DESCRIPTION	PUISSANCE
IN008038	AMPOULE B22 ECO 15W (=75W) 220W	Pu 15 W
IN008037	AMPOULE E27 ECO 15W (=75W) 220W	Pu 15 W

STARTER POUR TUBE FLUORESCENT



RÉF. ART.	DESCRIPTION
IN008036	4-22W (DOUBLE)
IN008035	4-65W (SIMPLE)

AMPOULE H1 POUR GYROPHARE



RÉF. ART.	DESCRIPTION	PUISSANCE
IN000066	AMPOULE H1 12W POUR GYROPHARE	Pu 12 W
IN000067	AMPOULE H1 24W POUR GYROPHARE	Pu 24 W

TUBE FLUORESCENT T8 D.26MM

SYLVANIA



RÉF. ART.	DESCRIPTION	LONGUEUR	PUISSANCE
IN004545		L 120 CM	Pu 36 W
IN004546		L 150 CM	Pu 58 W
IN007947		L.600MM 18W	Pu 18 W

AMPOULE LED



RÉF. ART.	DESCRIPTION	PUISSANCE
IN020808	PRIMER LEDER 9W CULOT E27	9W
IN020809	AZP ENERGY LIGHTING 12W CULOT E27	12W
IN020810	OPTONICA STANDARD 10W CULOT B22	10W

photos non contractuelles

CHARGEUR UNIVERSEL POUR PILE RECHARGEABLE

VARTA



AO2312

RÉF. ART.

IN000532

PILE 1,5V

VARTA



RÉF. ART.

DESCRIPTION

IN005298

LR14 - BLISTER DE 2

IN005299

LR20 - BLISTER DE 2

PILE 9V

VARTA



RÉF. ART.

DESCRIPTION

IN005682

LR22 - BLISTER DE 1

PILE PVC POUR LAMPE PORTO (RECHARGE)

VARTA



RÉF. ART.

IN005700

PILE RECHARGEABLE SANS EFFET



SANS EFFET MEMOIRE

RÉF. ART.	DESCRIPTION
IN005708	MÉMOIRE LR14 - BLISTER DE 2
IN005709	MÉMOIRE LR20 - BLISTER DE 2
IN005707	MÉMOIRE LR3 - BLISTER DE 4
IN005711	MÉMOIRE LR6 - BLISTER DE 4
IN005710	MÉMOIRE LR622 - BLISTER DE 1

PILES ALCALINES 1,5V



RÉF. ART.	DESCRIPTION
IN005300	LR3 1,5V - BLISTER DE 4
IN005301	LR6 1,5V - BLISTER DE 4

photos non contractuelles

POSTE EMETTEUR/RECEPTEUR

AVEC CHARGEUR + BATTERIE LIION // DISPONIBLE ÉGALEMENT À LA LOCATION DISTRIPLUS



RÉF. ART.	DESCRIPTION
EL020913	POSTE E/R - DP1400 - VHF NUMERIQUE 136-174 MHZ

BATTERIE CP/DP1400

MOTOROLA



Postes E/R disponible également à la location Distriplus

RÉF. ART.	DESCRIPTION
EL020916	LI ION 1600 MAH

CHARGEUR POUR DP1400

MOTOROLA



Postes E/R disponible également à la location Distriplus

RÉF. ART.	DESCRIPTION
EL020914	CHARGEUR 1 CASE POUR DP1400 CHARGEUR SIMPLE - SECTEUR
EL020919	CHARGEUR 6 CASES POUR DP1400 POUR CHARGEMENTS EN SERIE

HOUSSE DE PROTECTION CUIR POUR DP1400

MOTOROLA



Postes E/R disponible également à la location Distriplus

RÉF. ART.
EL020915

MICRO POUR DP1400

MOTOROLA



Postes E/R disponible également à la location Distriplus

RÉF. ART.	DESCRIPTION
EL020917	MICRO DEPORTE EQUIPE GRUTIER MICRO HP AVEC PEDALE PR DP1400
EL020918	MICRO HP DEPORTE MICRO DEPORTE - AU SOL POUR DP1400

TRANSPORT EXPRESS

LE SERVICE TRANSPORT EXPRESS SUR MESURE VOUS ASSURE L'ENLÈVEMENT ET LA LIVRAISON DE COLIS, PLANS, PALETTES ET HORS-GABARIT DANS LES DÉLAIS LES PLUS COURTS.



RÉF. ART.	DESCRIPTION
Transport express	L.BONAVENTURE@bouygues-construction.com j.imboden@bouygues-construction.com

Une idée de nouveau produit ?



RÉF. ART.	DESCRIPTION
NOUVEAU PRODUIT	mailto:t.bobin@bouygues-construction.com

VERIFIEZ LA DISPONIBILITE DE NOS PRODUITS

DISTRIMO



En scannant le QR code, vérifiez le stock des produits à l'aide des références et de la barre de recherche

RÉF. ART.	DESCRIPTION
SITE WEB	http://distrimo.bouygues-construction.com/

photos non contractuelles

PLATEFORME GAZELLE MAXI

DUARIB



Plateforme de travail au droit avec plancher réglable à 50, 65 et 85cm. Dimension plancher : 85 x 50cm. Portillon à retour automatique. Marches antidérapantes de 80mm.

RÉF. ART.	DESCRIPTION	EPAISSEUR
PO003633	100CM POUR ESCALIER HÉLICOÏDAL	H 65/100 CM
PO003634	65-100CM	H 65/100 CM

PLATEFORME GAZELLE MINI

DUARIB



Plateforme de travail au droit avec plancher réglable à 50, 65 et 85cm. Dimension plancher : 85 x 50cm. Portillon à retour automatique. Marches antidérapantes de 80mm.

RÉF. ART.	DESCRIPTION	EPAISSEUR
PO003635	50-85CM	H 50/85 CM

PLATE-FORME INDIV. ALU ULTRALIGHT

AUDINNOV



Poids : 12 kg Ht plateau : 0.50 m Empattement déployé : 1040 mm

RÉF. ART.	DESCRIPTION
PO017337	PLATE-FORME INDIV. ALU 2 MARCHES - LX02 / 2 BRX ULTRALIGHT
PO017338	PLATE-FORME INDIV. ALU 3 MARCHES - LX03 / 3 BRX ULTRALIGHT
PO017336	PLATE-FORME INDIV. ALU 4 MARCHES - LX04 / 4 BRX ULTRALIGHT
PO017339	PLATE-FORME INDIV. ALU 5 MARCHES - LX05 / 5 BRX ULTRALIGHT

PLATEFORME AIMANTEE ENTRE BANCHES

DUARIB



Hauteur de plateau : 0,95 m. Poids 1- kg . Encombrement au sol : 713 x 725 mm Aimantée à la peau coffrante.

RÉF. ART.	EPAISSEUR
PO020232	H 1 M Plancher

photos non contractuelles

PLATEFORME INDIVIDUELLE SPÉCIALE BANCHE

FORTAL



PIRL Garde-corps démontables plateau à 688 mm hauteur de travail à 2700 mm

RÉF. ART.	DESCRIPTION	EPAISSEUR
PO003645	PLATEFORME INDIVIDUELLE 3 MARCHES SPÉCIALE BANCHE	H 3 Ma
PO003647	PLATEFORME INDIVIDUELLE 4 MARCHES SPÉCIALE BANCHE	H 4 Ma
PO003649	PLATEFORME INDIVIDUELLE 5 MARCHES SPÉCIALE BANCHE	H 5 Ma
PO003651	PLATEFORME INDIVIDUELLE 6 MARCHES SPÉCIALE BANCHE	H 6 Ma
PO003653	PLATEFORME INDIVIDUELLE 7 MARCHES SPÉCIALE BANCHE	H 7 Ma

PLATEFORME INDIVIDUELLE ROULANTE PLIANTE ENTRE BANCHES

DUARIB



PIRL PLIABLE, pour faciliter le stockage et la minipulation, avec garde-corps démontables plateau à 688 mm hauteur de travail à 2700 mm

Facilité de manipulation et de stockage.

RÉF. ART.	DESCRIPTION	EPAISSEUR
PO003637	3 M	H 3 Ma
PO003638	4 M	H 4 Ma
PO003639	5 M	H 5 Ma
PO003640	6 M	H 6 Ma
PO007935	7 M	H 7 Ma

PLATE-FORME INDIVIDUELLE ALU WHEELYS

DUARIB



avec 4 roues escamotables. Hauteur plancher 0.70 m Hauteur travail 2.70 m Poids 20,9 kg

RÉF. ART.	DESCRIPTION
PO105924	3 MARCHES
PO105925	4 MARCHES

PLATEFORME INDIVIDUELLE EN ALUMINUM

CENTAURE



PIRL Hauteur de travail: 2,45m

RÉF. ART.	DESCRIPTION	EPAISSEUR
PO003643	2 MARCHES BASE ÉVASÉE	H 2 Ma
PO008617	2 MARCHES LÉGÈRE	H 2 Ma
PO003644	3 MARCHES BASE ÉVASÉE	H 3 Ma
PO003646	4 MARCHES BASE ÉVASÉE	H 4 Ma
PO003648	5 MARCHES	H 5 Ma
PO003650	6 MARCHES	H 6 Ma
PO003652	7 MARCHES	H 7 Ma

photos non contractuelles

PLATEFORME INDIVIDUELLE EN ALUMINIUM POUR POSE DE POTELET

FORTAL



PIRL EN TETE DE VOILE JUSQU'À 2,85M AVEC MAIN COURANTE

RÉF. ART.	EPAISSEUR
PO003657	H 190/280 CM

PLATEFORME INDIVIDUELLE TÉLESCOPIQUE

CENTAURE



AVEC LISSE RABATABLE SUR GC RIGIDES

RÉF. ART.	DESCRIPTION	EPAISSEUR
PO003654	3 À 5 MARCHES	H 3/5 Ma
PO003655	4 À 7 MARCHES	H 4/7 Ma
PO003656	6 À 9 MARCHES	H 6/9 Ma

PLATEFORME INDIVIDUELLE SOUS CROCHET POUR PRÉMUR

DUARIB



RÉF. ART.	DESCRIPTION	EPAISSEUR
PO003658	3,8M	H 192/310 CM
PO003659	5M	H 239/404 CM

PLATEFORME RAYONNAGE STEPPER

CENTAURE



RÉF. ART.	DESCRIPTION	EPAISSEUR
PO020222	PLATE-FORME RAYONNAGE STEPPER 1 MARCHE	1 marches
PO020221	PLATE-FORME RAYONNAGE STEPPER 2 MARCHES	2 marches

photos non contractuelles

GARDE CORPS LATERAL POUR PLATEFORME INDIVIDUELLE CENTAURE

CENTAURE



PIRL CENTAURE PL2_PIRL CENTAURE PL3_PIRL CENTAURE PL4_PIRL CENTAURE PL5_PIRL CENTAURE PL6_PIRL CENTAURE PL7_PIRL CENTAURE PLSCOP3/5_PIRL CENTAURE PLSCOP4/7_PIRL CENTAURE PLSCOP6/9
1 GC GAUCHE ET 1 GC DROIT POUR PLATEFORME INDIVIDUELLE CENTAURE - LA PAIRE

RÉF. ART.
PO005127

LISSE RABATABLE SUR GARDE-CORPS LATÉREAUX PLATEFORME INDV

CENTAURE



PIRL CENTAURE PL2_PIRL CENTAURE PL3_PIRL CENTAURE PL4_PIRL CENTAURE PL5_PIRL CENTAURE PL6_PIRL CENTAURE PL7_PIRL CENTAURE PLSCOP3/5_PIRL CENTAURE PLSCOP4/7_PIRL CENTAURE PLSCOP6/9
LISSE ALU RABATABLE SUR GC LATÉREAUX PR PLATEFORME INDIVIDUELLE CENTAURE

RÉF. ART.
PO005204

PATINS POUR PLATEFORME CENTAURE

CENTAURE



GAZELLE MAXI
2 PATINS COIFFANTS POUR PLATEFORMES INDIVIDUELLES ALU CENTAURE -

RÉF. ART.
PO005261

PIEDS TÉLESCOPIQUES POUR GAZELLE MAXI EN ESCALIER

DUARIB

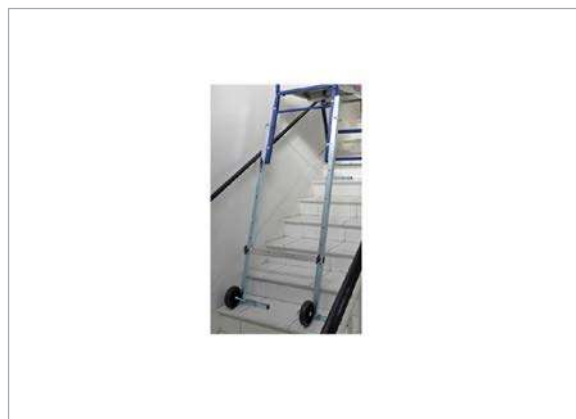

PIRL CENTAURE PL2_PIRL CENTAURE PL3_PIRL CENTAURE PL4
Jeu de 2 pieds télescopiques à adapter sur Gazelle MAXI DUARIB pour un travail au droit dans des escaliers hélicoïdaux.

RÉF. ART.
PO005296

photos non contractuelles

ROUES POUR PLATEFORME INDIVIDUELLE

CENTAURE



PIRL CENTAURE PL5_PIRL CENTAURE PL6_PIRL CENTAURE PL7
2 ROUES D100MM POUR PIRLS AE201A/AE202A

RÉF. ART.	DESCRIPTION
PO005388	2 À 4 MARCHES D.100MM
PO005389	CENTAURÉ 5 À 7 MARCHES

STABILISATEURS POUR PLATEFORME DE 5 À 7M CENTAURE

CENTAURE



PIRL CENTAURE PLSCOP4/7
STABILISATEURS DROITE ET GAUCHE

RÉF. ART.	DESCRIPTION
PO005438	STABILISATEURS POUR PLATEFORME DE 3 À 5M CENTAURE

ROUES POUR PLATEFORME TÉLESCOPIQUE

CENTAURE



PIRL CENTAURE PLSCOP3/5
2 ROUES D200MM POUR PIRLS AE1200/AE1201/AE1202

RÉF. ART.	DESCRIPTION
PO005387	D.200MM

STABILISATEURS POUR PLATEFORME TÉLÉSCO.

CENTAURE

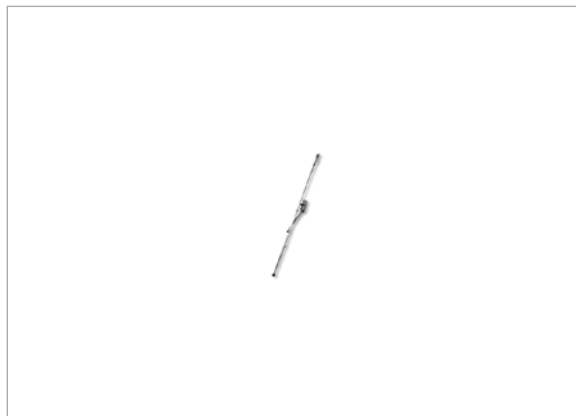

PIRL CENTAURE PLSCOP6/9
STABILISATEURS DROITE ET GAUCHE

RÉF. ART.	DESCRIPTION
PO005440	DE 4 À 7M CENTAURE
PO005441	DE 6 À 9M CENTAURE

photos non contractuelles

TABLETTE PORTE OUTILS POUR PLATEFORME ALU CENTAURE

CENTAURE



RÉF. ART.	DESCRIPTION
PO005446	- L'UNITE

GARDE-CORPS ALU LATERAL POUR PLATEFORME OPP FORTAL

FORTAL

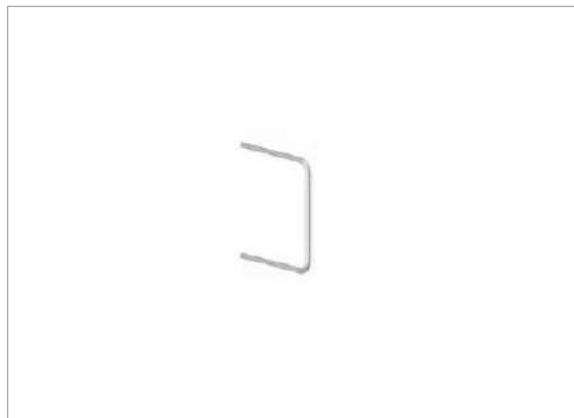

RÉF. ART.	DESCRIPTION
PO005129	L'UNITE

GARDE-CORPS ALU LATERAL POUR PLATEFORME BANCHE FORTAL

FORTAL

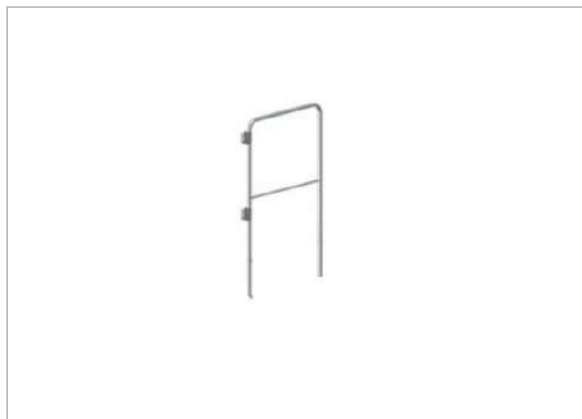

RÉF. ART.	DESCRIPTION
PO005128	L'UNITE

PORTILLON D'ACCES POUR PLATEFORME BANCHE FORTAL

FORTAL

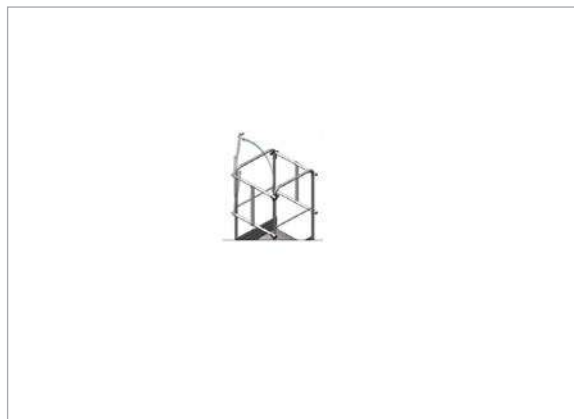

RÉF. ART.	DESCRIPTION
PO005339	PORTILLON D'ACCES POUR PLATEFORME BANCHE LARG.550MM FORTAL

photos non contractuelles

PORTILLON D'ACCES POUR PLATEFORME OPP FORTAL

FORTAL



RÉF. ART.	DESCRIPTION
PO005340	L'UNITE

Une idée de nouveau produit ?



RÉF. ART.	DESCRIPTION
NOUVEAU PRODUIT	mailto:t.bobin@bouygues-construction.com

LA REPARATION, écologique et économique



RÉF. ART.
REPARATION

photos non contractuelles

ESCALIER MANUFORTABLE DE CHANTIER

DUARIB

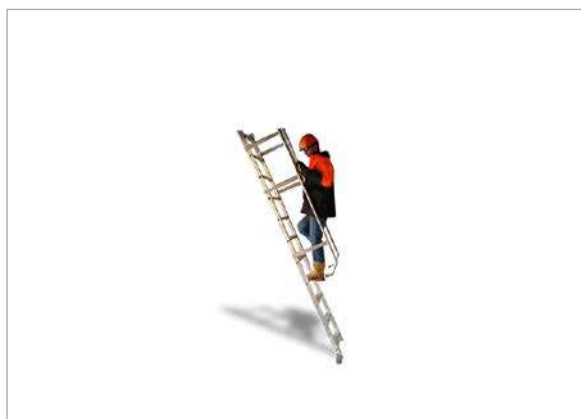

Escalier temporaire à fixer en tête et en pieds permettant un accès en sécurité dans les trémies de pavillon. Prix dégressif à partir de quantités. Hauteur plancher max 2,77m. Escalier équipé de mains courantes soudées et portillon d'accès boulonnées.

RÉF. ART.	LONGUEUR	LARGEUR	EPAISSEUR
PO008542	L 90 CM	I 24 CM	H 277 CM

MARCHE POUR PETIT ESCALIER

T.A.P FRANCE



Marche indépendante à fixer sur bastaing pour permettre l'accès sur petits dénivelés. Possibilité d'enficher des potelets gardes-corps et plinthes

RÉF. ART.	DESCRIPTION
PO002837	L.90CM L.24CM

OUTIL D'ACCÈS MAD SKYDOM

ULTRALU



Réglable de 2,26 m à 3 m. Nous pouvons vous proposer d'autres outils d'accès sur commande : > Réglable de 3 m à 4 m > Réglable de 3,5 m à 5 m > Autre demande

RÉF. ART.
PO017781

OUTIL D'ACCES TÉLESCOPIQUE SUR DALLE

ULTRALU



OUTIL D'ACCES TELESCOPIQUE SUR DALLE MAD 5P AVEC CORNIERES AU SOL

RÉF. ART.	DESCRIPTION	EPAISSEUR
PO010658	AVEC CORNIÈRE AU SOL	H 160/290 CM

photos non contractuelles

PASSERELLE DE CHANTIER

HAEMMERLIN



Passelle de tranchées largeur de passage 1ml, longueur 2ml11. Plancher anti-dérapant riveté en aluminium. Rampes d'accès incorporées 2 garde-corps acier Ø28MM, bandes clanche non réfléchissantes. Revêtement epoxy-polyester rouge. Garde-corps repliables pour faciliter la manutention.

RÉF. ART.	DESCRIPTION	EPAISSEUR
PO018265	2,11ML X 1ML	2ML11x1ML

PLAQUE DE PASSAGE DE TRANCHEE JAUNE

AXIMUM



1200X800X25MM - FIBRE DE VERRE - CAPACITE 500 KG

RÉF. ART.	DESCRIPTION	REFERENCE FABRICANT
PO112966	en fibre de verre	52 05 21

PODIUM ALUMINIUM À 2 MARCHES

FORTAL

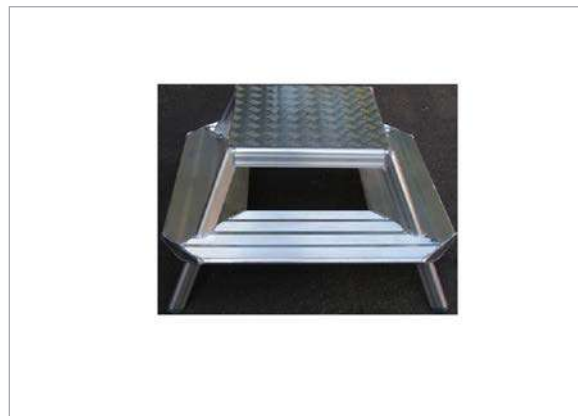

Accès par les 4 côtés, plateau à 0,50 mètre, 10 kg, pas de garde-corps

RÉF. ART.	DESCRIPTION	LONGUEUR	EPAISSEUR
PO003671	, ACCÈS PAR 4 CÔTÉS	L 300 CM	H 48 CM

QUAI MOBILE DE CHARGEMENT

FORTAL



Pour chargement et déchargement des camions en sécurité, plateau de travail en 3 mètres de long et 1,40m de haut, hauteur de travail à 3,40 m. Equipée de 4 roues de diamètre 200 mm à frein, garde corps, portillon à fermeture automatique et protection anti choc au niveau du plateau. poids 170 kg, longueur hors tout 4,22m

RÉF. ART.	DESCRIPTION	EPAISSEUR
PO003758	POUR CAMION PLAUTEAU 3M	H 140 CM

photos non contractuelles

OUTIL D'ACCES REMORQUE CAMION

ULTRALU



A utiliser au cas où le quai de chargement ne peut pas être installé. Hauteur d'accès réglable : 1,21 à 1,50 m. Hauteur max verticale : 2,52 m Poids : 16 kg

RÉF. ART.	DESCRIPTION
PO020873	150

LA REPARATION, écologique et économique

Pensez à la réparation,

la planète vous remercie

RÉF. ART.
REPARATION

Une idée de nouveau produit ?

Une idée de nouveau produit ?

n'hésitez pas à nous la remonter :
t.bobin@bouygues-construction.com

RÉF. ART.	DESCRIPTION
NOUVEAU PRODUIT	mailto:t.bobin@bouygues-construction.com

SUR COMMANDE = soumis à des délais supérieurs à ceux habituels

SUR COMMANDE = SOUMIS À DES DÉLAIS SUPÉRIEURS À CEUX HABITUELS



RÉF. ART.
SUR COMMANDE

OUTIL D'ACCES REMORQUE CAMION

ULTRALU



A utiliser au cas où le quai de chargement ne peut pas être installé. Hauteur d'accès réglable : 1,45 à 1,73 m. Hauteur max verticale : 2,75 m Poids : 18,8 kg

RÉF. ART.	DESCRIPTION	LONGUEUR	LARGEUR
PO106551	170	L 180 CM	I 65 CM

photos non contractuelles

ECHAFAUDAGE EN ALUMINIUM AVEC PLANCHER

TUBESCA COMABI



Plancher ht 4,00 m, 0,60 m * 1,42 m

RÉF. ART.	DESCRIPTION	LONGUEUR	LARGEUR	EPAISSEUR
PO001962	L.180CM L.65CM	L 190 CM	1 67 CM	H 4 M

ECHAFAUDAGE GENERIS 750 ALUMINIUM

TUBESCA COMABI



RÉF. ART.	DESCRIPTION	LONGUEUR	LARGEUR	EPAISSEUR
PO001964	AVEC PLANCHER H.3ML	L 190 CM	1 67 CM	H 3 M
PO001965	AVEC PLANCHER H.6ML	L 290 CM	1 76 CM	H 6 M

ECHAFAUDAGE GENERIS ALUMINIUM

TUBESCA COMABI



RÉF. ART.	DESCRIPTION	LON- GUEUR	LAR- GEUR	EPAIS- SEUR
PO001963	ECHAFAUDAGE GENERIS 950 ALUMINIUM AVEC PLANCHER H.3ML	L 186 CM	1 54 CM	H 3 M

ECHAFAUDAGE JUNIOR

TUBESCA COMABI



Largeur pieds fermés 0,68m - Passe dans les portes de 73cm - - plancher ht 4,8m 0,54m*1,866

RÉF. ART.	DESCRIPTION	LONGUEUR	LARGEUR	EPAISSEUR
PO001966	H.4,8M	L 280 CM	1 90 CM	H 4,80 M

ECHAFAUDAGE ROULANT ALU STARLIUM 280

TUBESCA COMABI



RÉF. ART.	DESCRIPTION	LONGUEUR	LARGEUR	EPAISSEUR
PO001961	AVEC PLANCHER H.4M	L 280 CM	I 90 CM	H 4 M
PO001968	AVEC PLANCHER H.2M	L 280 CM	I 90 CM	H 2 M
PO001969	AVEC PLANCHER H.6M			H 6 M

ECHAFAUDAGE TELETOWER

DUARIB



RÉF. ART.	DESCRIPTION	EPAISSEUR
PO020231	HT PLANCHER 0,33ML À 2,00ML	H 2 M

ECHAFAUDAGE ALU NEOLIUM 300

TUBESCA COMABI



RÉF. ART.	DESCRIPTION
PO101040	BOX 2M PLANCHER 4M TRAVAILLE (VENDU A L'UNITÉ)
PO101041	BOX 4M PLANCHER 6M TRAVAILLE (VENDU A L'UNITÉ)
PO101042	BOX 6M PLANCHER 8M TRAVAILLE (VENDU A L'UNITÉ)

photos non contractuelles

GOUPILLES POUR ÉCHAFAUDAGE GÉNÉRIS

TUBESCA COMABI



RÉF. ART.	DESCRIPTION
PO005135	, 5 PIÈCES

PANNEAU DE CHARGE POUR ÉCHAFAUDAGE ROULANT

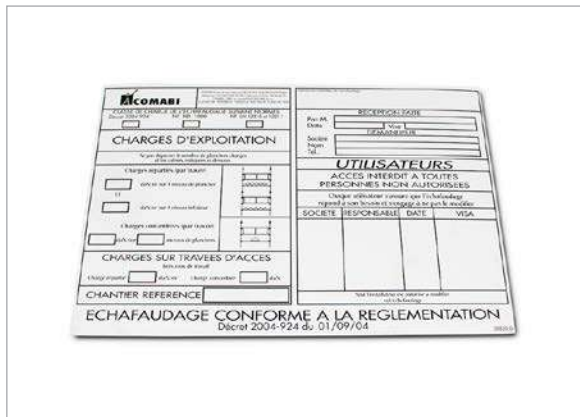

RÉF. ART.
PO003360

PLAQUETTE EN PVC LOGO POUR ECHAFAUDAGE

FOURNITURE PLAQUETTE PVC DE 250 X 130 MM SERIGRAPHIÉE (LOGO ENTREPRISE)



RÉF. ART.	DESCRIPTION
PO003598	PLAQUETTE EN PVC LOGO BRÉZILLON L.250MM L.130MM
PO003600	PLAQUETTE EN PVC LOGO BYBAT IDF L.250MM L.130MM
PO003607	PLAQUETTE EN PVC LOGO HAR L.250MM L.130MM
PO003608	PLAQUETTE EN PVC LOGO HAS L.250MM L.130MM
PO003606	PLAQUETTE LOGO BY BAT CENTRE SUD OUEST POUR POCLETTE ECHAF
PO003612	PLAQUETTE LOGO BY BAT GRAND OUEST POUR POCLETTE ECHAFAUDAGE
PO003611	PLAQUETTE LOGO BY BAT NORD EST POUR POCLETTE ECHAFAUDAGE
PO003605	PLAQUETTE LOGO BY BAT SUD EST POUR POCLETTE ECHAFAUDAGE
PO003599	PLAQUETTE LOGO BY CONS.SERV.NUC. POUR POCLETTE ECHAF
PO003602	PLAQUETTE LOGO BY TP POUR POCLETTE ECHAFAUDAGE
PO003603	PLAQUETTE LOGO BY TP RF POUR POCLETTE ECHAFAUDAGE
PO003604	PLAQUETTE LOGO BYES POUR POCLETTE ECHAFAUDAGE
PO003609	PLAQUETTE LOGO LOSINGER MARAZZI POUR POCLETTE ECHAFAUDAGE

POCHETTE D'AFFICHAGE 4 OEILLETS POUR DOCUMENT A4

POCHETTE NYLON 50/100 BLANC DESSUS CRISTAL SOUPLE 25/100, FORMAT EXTÉRIEUR = 375 X 320 MM, FENTE ET OUVERTURE PAR L'ARRIÈRE, 4 OEILLETS AUX ANGLES, PAS DE MARQUAGE, FENTE ET OUVERTURE PAR L'ARRIÈRE (EN PARTIE INFÉRIEURE), SOUDURE BÂCHE CONTRE BÂCHE



RÉF. ART.
PO009637

photos non contractuelles

POCHETTE D'ECHAFAUDAGE SANS LOGO

POCHETTE NYLON 50/100 BLANC DESSUS CRISTAL SOUPLE 25/100, FORMAT EXTÉRIEUR = 380 X 460 MM, FORMAT Pochette pour insertion document = 240 X 360 MM, RETOUR CRYSTAL EN PARTIE SUPÉRIEURE POUR INSERTION PLAQUETTE LOGO PVC 1MM DE 250 X 120 MM, FENTE ET OUVERTURE PAR L'ARRIÈRE (EN PARTIE INFÉRIEURE), SOUDURE BÂCHE CONTRE BÂCHE EN PARTIE SUPÉRIEURE AVEC RETOUR CRYSTAL POUR INSERTION LOGO SUR PLAQUETTE AMOVIBLE



RÉF. ART.
PO003669

LA REPARATION, écologique et économique



RÉF. ART.
REPARATION

VERIFIEZ LA DISPONIBILITE DE NOS PRODUITS

DISTRIMO



En scannant le QR code, vérifiez le stock des produits à l'aide des références et de la barre de recherche

RÉF. ART.	DESCRIPTION
SITE WEB	http://distrimo.bouygues-construction.com/

VALDELIA

ECO ORGANISME VALDELIA



Flashez le QR code pour découvrir en détail le service ou bien : <https://bycnmateriel.odoo.com/montage-mobilier>

RÉF. ART.	DESCRIPTION
VALDELIA	Le mobilier de chantier peut être gratuitement récupéré pour dons, vente ou recyclage.

photos non contractuelles

AIGUILLE LONG

SIBILLE



RÉF. ART.	DESCRIPTION
OU105826	200M - LARG 9MM SUR DEVIDOIR VERTICAL
OU105827	60M - LARG 5,5MM SUR DEVIDOIR VERTICAL FREINE

ALROC - PINCE COMPOSITE ISOLEE

SIBILLE



RÉF. ART.	DESCRIPTION
OU105828	CC 2.0 CL 2.0 26 A 52MM

ALROC MULTI-FONCTION.GAINE-ISOLANT-SEMI.P

SIBILLE



RÉF. ART.	DESCRIPTION
OU105829	25-240°
OU105830	50-630° STYLETUN

photos non contractuelles

AMPEREMETRE



RÉF. ART.	DESCRIPTION
OU103612	CA MA400D 0,02 A 400A

BROSSE A CONDUCTEUR



RÉF. ART.	DESCRIPTION
OU103625	2 ECOUVILLONS
OU103624	ROUGE CUIVRE
OU103626	BROSSE POUR CONDUCTEUR ALUMINIUM

CHAUSSETTE SIMPLE BOUCLE GALVA POUR RESEAU AERIE

SIBILLE



RÉF. ART.	DESCRIPTION
OU105831	10/15MM

CISAILLE MANCHES ISOLES



RÉF. ART.
OU103597

CHAUSSETTE SIMPLE BOUCLE GALVA POUR RESEAU SOUTERRAIN

SIBILLE



RÉF. ART.	DESCRIPTION
OU105832	15/25MM
OU105833	25/45MM
OU105834	45/60MM
OU105835	60/80MM
OU105836	80/100MM

CISEAUX D'ELECTRICIENS ISOLES



RÉF. ART.
OU103799

photos non contractuelles

CISEAUX ENTIEREMENT ISOLES

SIBILLE



RÉF. ART.	DESCRIPTION
OU105837	L 135MM SANS ETUI
OU103826	

CLE A CLIQUET REV ISOLE CEI



RÉF. ART.	DESCRIPTION
OU103769	ENT. 1/2"
OU103768	ENT. 3/8"

CLE A BEQUILLES 6 PANS EN T



RÉF. ART.	DESCRIPTION
OU103727	10MM
OU103728	12MM
OU103729	13MM
OU103730	14MM
OU103731	16MM
OU103732	17MM
OU103733	19MM
OU103734	21MM
OU103735	22MM

CLE A MOLETTE ISOLEE



RÉF. ART.	DESCRIPTION	REFERENCE FABRICANT
OU103739	CEI 385MM .	
OU007926	310MM OUVERTURE 34 MAXI	MO69004

CLE A OEIL CONTRE COUDEE ISOLEE



RÉF. ART.	DESCRIPTION
OU103702	CEI 8MM
OU103703	CEI 12MM
OU103704	CEI 13MM
OU103705	CEI 14MM
OU103706	CEI 17MM
OU103707	CEI 19MM
OU103708	CEI 21MM
OU103709	CEI 22MM
OU103710	CEI 23MM
OU103711	CEI 24MM
OU103712	CEI 26MM
OU103713	CEI 30MM
OU103714	CEI 32MM

photos non contractuelles

CLE A PIPE 12 PANS ISOLEE CEI



RÉF. ART.	DESCRIPTION
OU103717	DE 13MM
OU103718	DE 10MM
OU103719	DE 14MM
OU103720	DE 16MM
OU103721	DE 17MM
OU103722	DE 18MM
OU103723	DE 19MM
OU103724	DE 23MM
OU103725	DE 24MM

CLE A PIPE 6 PANS ISOLEE CEI



RÉF. ART.	DESCRIPTION
OU103715	DE 8MM
OU103716	DE 7MM

CLE DYNAMO.REVERSIBLE 3/8"



RÉF. ART.	DESCRIPTION
OU103740	8 À 50 NM

CLE EN CROIX CEI



RÉF. ART.	DESCRIPTION
OU103737	6/8/10/12MM
OU103738	8/10/13/17MM

photos non contractuelles

CLE ISOLEE A PISTON POUR CONNECT. ANNEAU



RÉF. ART.
OU103620

CLE MALE COUDEE ISOLEE CEI



RÉF. ART.	DESCRIPTION
OU103792	3MM
OU103793	4MM
OU103794	5MM
OU103795	6MM
OU103796	7MM
OU103797	8MM
OU103798	10MM

CLE PLATE A FOURCHE ISOLEE CEI



RÉF. ART.	DESCRIPTION
OU103687	8MM
OU103688	10MM
OU103689	12MM
OU103690	13MM
OU103691	14MM
OU103692	16MM
OU103693	17MM
OU103694	18MM
OU103695	19MM
OU103696	21MM
OU103697	22MM
OU103698	23MM
OU103699	26MM
OU103700	30MM
OU103701	32MM

CLE POLY.REVERSIBLE A CLIQUET



RÉF. ART.	DESCRIPTION
OU103741	10MM
OU103742	13MM
OU103743	16MM
OU103744	17MM
OU103745	18MM
OU103746	19MM

photos non contractuelles

CLE POUR DISTRIB. DE COLONNES MONTANTES



RÉF. ART.
OU103824

CLE TRIANGULAIRE



RÉF. ART.	DESCRIPTION
OU103726	DE 11MM

COFFRET TOURNEVIS À FRAPPER

SAM OUTILLAGE



RÉF. ART.
OU103493

CONNECTEUR SHUNT-CABLE ETANCHE

SIBILLE



RÉF. ART.
OU105838

CONTROLEUR D'ISOLEMENT



RÉF. ART.
OU103600

photos non contractuelles

COUPE CABLE A CREMAILLIERE



RÉF. ART.	DESCRIPTION
OU103685	OUVERTURE 38MM
OU103686	OUVERTURE 55MM

COUPEAU 2 LAMES DENUDE CABLE

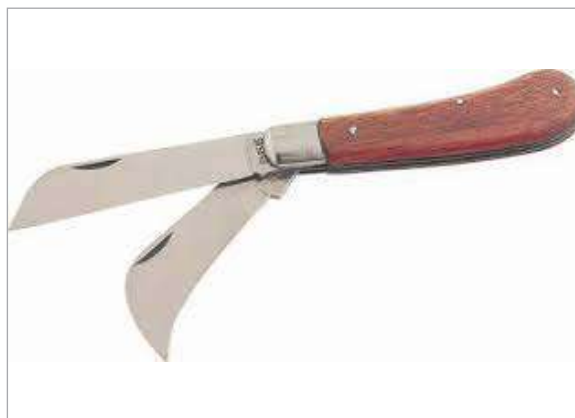

RÉF. ART.
OU007805

COUPE-CÂBLES KNIPEX

KNIPEX



RÉF. ART.	DESCRIPTION
OU001528	COUPE-CÂBLES D.32MM KNIPEX
OU001529	COUPE-CÂBLES D.52MM KNIPEX

COUPEAU A DENUDEUR ISOLANT CEI



RÉF. ART.
OU103643

COUPEAU ÉLECTRICIEN 2 LAMES

SAM OUTILLAGE



RÉF. ART.
OU001751

photos non contractuelles

COUPEAU ISOLE

SIBILLE



RÉF. ART.	DESCRIPTION
OU105839	LAME COURTE COURBE + ETUI
OU105840	LAME LONGUE EPAISSE + ETUI

DOUILLE 12 PANS FEMELLE 3/8



RÉF. ART.	DESCRIPTION
OU103791	LONGUE- 23MM

DOUILLE 3/4 - 6 PANS

SAM OUTILLAGE



RÉF. ART.	DESCRIPTION
OU103583	Ø 19
OU103584	Ø 21
OU103585	Ø 27
OU103586	Ø 28
OU103587	Ø 29
OU103588	Ø 30
OU103589	Ø 33
OU103590	Ø 35

DOUILLE 6 PANS FEMELLE 3/8 LONGUE



RÉF. ART.	DESCRIPTION
OU103776	- 10MM
OU103777	- 10MM
OU103778	- 12MM
OU103779	- 13MM
OU103780	- 13MM
OU103781	- 14MM
OU103782	- 14MM
OU103783	- 16MM
OU103784	- 16MM
OU103785	- 17MM
OU103786	- 17MM
OU103453	- 18MM
OU103787	- 18MM
OU103788	- 19MM
OU103789	- 21MM
OU103790	- 22MM
OU103775	- 8MM

photos non contractuelles

DOUILLE 6 PANS MALE 1/2



RÉF. ART.	DESCRIPTION
OU103765	- 5MM
OU103766	- 6MM
OU103767	- 8MM

DOUILLE ISOLEE CEI ENTRANEUR 3/8"



RÉF. ART.	DESCRIPTION
OU103747	10MM
OU103748	13MM
OU103749	14MM
OU103750	16MM
OU103751	17MM
OU103752	19MM

DOUILLE ISOLEE CEI ENTRANEUR 1/2"



RÉF. ART.	DESCRIPTION
OU103755	10MM
OU103756	12MM
OU103757	13MM
OU103758	14MM
OU103759	16MM
OU103760	17MM
OU103761	18MM
OU103736	19MM
OU103762	21MM
OU103763	22MM
OU103764	23MM

DOUILLE ISOLEE CEI ENTRANEUR 1/2"



RÉF. ART.	DESCRIPTION
OU103754	DOUILLE ISOLEE CEI, ENTRANEUR 1/2" 8MM

photos non contractuelles

DOUILLE MALE ISOLEE ENT.3/8"



RÉF. ART.	DESCRIPTION
OU103753	,5MM.

ETUI EN TOILE DE CEINTURE POUR PINCE P126

SIBILLE



RÉF. ART.	DESCRIPTION
OU105844	

EMERILLON

SIBILLE



RÉF. ART.	DESCRIPTION
OU105841	DIAM 34MM

EVASEUR POUR GAINE PLOMB

SIBILLE



RÉF. ART.	DESCRIPTION
OU105845	(BT-HTA)

ENSEMBLE HABILLEUR DE FOUILLES

SIBILLE

4 PERCHES ISOLANTES DE 3 ÉLÉMENTS TP01 + SAC EN TOILE TS14S

RÉF. ART.	DESCRIPTION
OU105842	(Perches isolantes + sac)

ETRIER D'ANCRAGE ACTV

SIBILLE

RÉF. ART.	DESCRIPTION
OU105843	

GOUGE ISOLANTE CABLE SOUTER



RÉF. ART.	DESCRIPTION
OU103623	

photos non contractuelles

INDICATEUR D'ORDRE DE PHASES

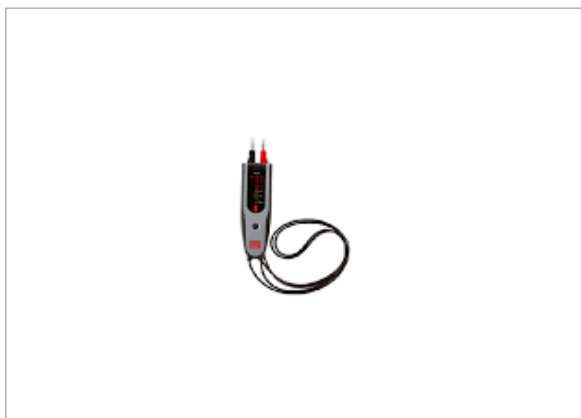

RÉF. ART.
OU103825

JEU MATRICES D36 / NFC20-130 :

SIBILLE

RÉF. ART.	DESCRIPTION
OU105851	6 MM ²
OU105846	10 MM ²
OU105847	16 MM ²
OU105848	25 MM ²
OU105849	35 MM ²
OU105850	50 MM ²

JEU MATRICES D51 / NFC20-130 :

SIBILLE

RÉF. ART.	DESCRIPTION
OU105852	150 MM ²
OU105853	185 MM ²
OU105854	4/120 MM ²

KIT D'HABILITATION ÉLECTRICIEN BS - CPI



POUR INTERVENTIONS DE REMPLACEMENT ET RACCORDEMENT COMPRENANT 1 MACARON DE CONDAMNATION, 1 CONDAMNATEUR DE DISJONCTEUR, 1 PAIRE DE LUNETTES, 1 PAIRE DE GANTS + SOUS GANTS, 1 VAT, 1 GUIDE

RÉF. ART.
OU007206

KIT ÉLECTRIQUE POUR CHANTIER REP



RÉF. ART.
OU005572

photos non contractuelles

KIT ÉLECTRIQUE POUR ELECTRO - MÉCANICIEN



RÉF. ART.
OU005571

LEVIER EN MATIERE ISOLANTE



RÉF. ART.
OU103631

KIT TOURNEVIS DYNAMOMETRIQUE 6PANS 4*40



RÉF. ART.
OU103610

MESUREUR DE BOUCLE DE TERRE



RÉF. ART.	DESCRIPTION
OU103599	-

photos non contractuelles

MULTIMETRE NUMERIQUE CATIII 600V



RÉF. ART.
OU103845

OUTIL A DEGAINER "KABIFIX",

SIBILLE



RÉF. ART.	DESCRIPTION
OU105855	CORP POLYAMIDE, Ø25MM

OUTIL À DÉGAINER LES CÂBLES

SAM OUTILLAGE



RÉF. ART.	DESCRIPTION
OU003290	D.8-28MM

OUTIL DE SERTISSAGE HYDRAULIQUE

SIBILLE



SERTISSAGE CONNECTEUR DE 4 À 150 MM² - TÊTE ROTATIVE 180°

RÉF. ART.	DESCRIPTION
OU105856	1 MAIN 35KN PR MATRICES D36
OU105857	2 MAINS 55KN PR MATRICES D55

OUTIL SEMI-CONDUCTEUR

SIBILLE



RÉF. ART.	DESCRIPTION
OU105858	NON PELABLE SANS SILICONE 18-60M

photos non contractuelles

PERCHE DE MESURE

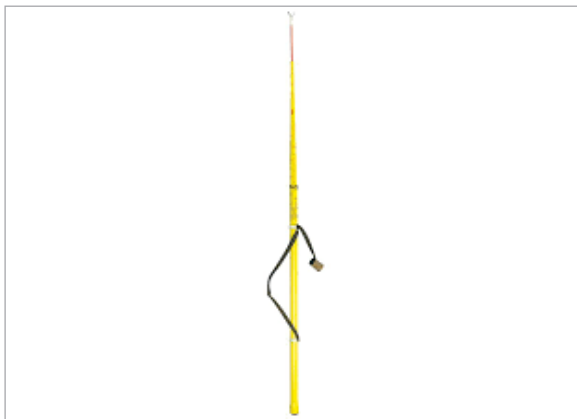

RÉF. ART.	DESCRIPTION
OU103800	DE HAUTEUR 12M

PINCE À BECS



RÉF. ART.	DESCRIPTION
OU103671	PINCE À BECS DEMI-RONDS 160MM
OU103673	PINCE À BECS PLATS ISOLEE CEI 160MM
OU103672	PINCE À BECS RONDS ISOLEE CEI 160MM

PINCE À COLLIER COLSON

LEGRAND



RÉF. ART.
OU007838

PINCE À DEGAINER LES CABLES BT



RÉF. ART.	DESCRIPTION
OU103676	PINCE À DEGAINER LES CABLES BT 16/150
OU103677	PINCE À DEGAINER LES CABLES BT 16/150
OU103678	PINCE À DEGAINER LES CABLES BT 50/240
OU103679	PINCE A DEGAINER LES CABLES BT 50/240

photos non contractuelles

PINCE À DÉNUDER

SAM OUTILLAGE



POUR FILS ELECTRIQUE

RÉF. ART.
OU003513

PINCE À DENUDER ENTIEREMENT ISOLEE

CATU



RÉF. ART.
OU103675

PINCE A DENUDER AUTOMATIQUE

FACOM



RÉF. ART.
OU003514

PINCE À SERTIR CATU

CATU



RÉF. ART.	DESCRIPTION
OU103680	PINCE À SERTIR

PINCE À DENUDER EN BOUT ISOLEE

KNIPEX



we life

RÉF. ART.	DESCRIPTION
OU010555	160MM

photos non contractuelles

PINCE À SERTIR SIBILLE

SIBILLE



RÉF. ART.	DESCRIPTION
OU105861	PINCE À SERTIR À CLIQUET 25KN AVEC EMPREINTE E140L9 FIXE
OU105862	PINCE À SERTIR MANUELLE PAR POINÇON ET BARILLET

PINCE COUPANTE DIAGONALE ISOLEE

CEI



RÉF. ART.	DESCRIPTION
OU103674	160M

PINCE AMPEREMETRIQUE



RÉF. ART.	DESCRIPTION
OU103846	CAT III
OU007941	PINCE AMPÈREMÉTRIQUE MULTIMÈTRE FL12

PINCE COUPE CABLE ISOLE



RÉF. ART.	DESCRIPTION
OU103682	CEI 170MM
OU103681	CEI 180MM
OU103683	CEI 230MM

photos non contractuelles

PINCE COUPE CABLE

KNIPEX



we  life

RÉF. ART.	DESCRIPTION
OU010556	ISOLEE 180MM

PINCE COUPE FEUILLARD



RÉF. ART.
OU103684

PINCE CROCODILE



RÉF. ART.	DESCRIPTION
OU103592	BRUNE
OU103593	JAUNE

**PINCE ÉLECTRONIQUE COUPANTE
DIAGONALE BECS POINTUS EFFILÉS**



RÉF. ART.
OU103508

PINCE MULTIMÈTRE

METRIX



RÉF. ART.	DESCRIPTION
OU007914	MX 355 - METRIX

photos non contractuelles

PINCE UNIVERSELLE ISOLEE



RÉF. ART.	DESCRIPTION
OU103670	CEI 200MM

POINTEST COUDE NON DETROMPE



RÉF. ART.	DESCRIPTION
OU103595	POINTEST BRUN COUDE NON DETROMPE 1,20M
OU103596	POINTEST NOIR COUDE NON DETROMPE 1,20M
OU103594	POINTEST VERT DROIT NON DETROMPE 1,20M

POINCON MANCHE ISOLANT

SIBILLE



RÉF. ART.	DESCRIPTION
OU105863	L270MM

POULIE DEROULAGE

SIBILLE



RÉF. ART.	DESCRIPTION
OU105864	1300DAN D.300MM
OU105865	500 DAN D.150MM
OU105866	800 DAN D.250MM

photos non contractuelles

PRISE DE POTENTIEL BEROPIK

SIBILLE



RÉF. ART.	DESCRIPTION
OU105867	N°1 10-75MM²
OU105868	N°2 50-300MM²

REDUCTEUR 3/8" POUR DOUILLE 1/4



RÉF. ART.
OU103774

RALLONGE ISOLEE CEI ENT.



RÉF. ART.	DESCRIPTION
OU103771	1/2" 130MM
OU103773	1/2" 250MM
OU103770	3/8" 140MM
OU103772	3/8" 264MM

SABOT DE TERRE SIMPLE A AILETTES -

SIBILLE

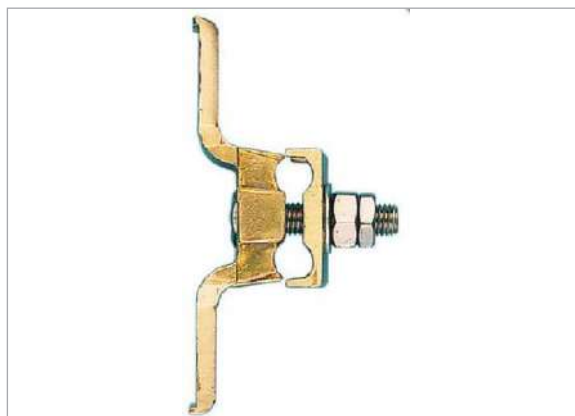

RÉF. ART.	DESCRIPTION
OU105869	120 A 240MM²
OU105870	40KA 1S 50 A 120MM²

photos non contractuelles

SACOCHE D'ELECTRICIEN



RÉF. ART.	DESCRIPTION
OU103611	-

SCIE JUNIOR ISOLEE CEI



RÉF. ART.	DESCRIPTION
OU103644	-

SCIE A BANDELETTE ISOLEE

SIBILLE



RÉF. ART.	DESCRIPTION
OU105871	TST

SERRE-CÂBLE DE TIRAGE DIT GRENOUILLE

SIBILLE



OUVERTURE : 6 À 14 MM - CHARGE : 800 CMU DAN - AL-LIAGE ALU

RÉF. ART.	DESCRIPTION
OU105872	-

SCIE A METAUX CEI



RÉF. ART.	DESCRIPTION
OU103645	LAME 300MM

photos non contractuelles

TESTEUR DE TENSION TM1AC

POUR TEST ELECTRIQUE DE PRESENCE TENSION



RÉF. ART.	REFERENCE FABRICANT
OU004131	2152272

TOURNEVIS CRUCIFORME PZ 1 DOUBLE EMPREINTE



RÉF. ART.	DESCRIPTION
OU103665	- 1000V

TOURNEVIS ISOLÉ 1000V

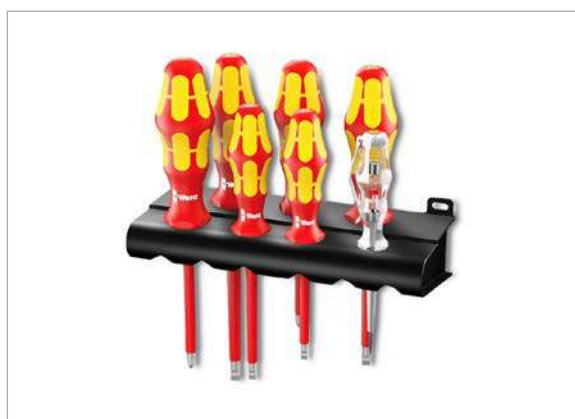

RÉF. ART.	DESCRIPTION
OU002473	- JEU DE 7 - WERA
OU103882	EXTRA-COURT POUR VIS À FENTE

TOURNEVIS PHILLIPS ISOLE CEI



RÉF. ART.	DESCRIPTION
OU103657	N° 1 4.5X80
OU103660	N° 2 6X100
OU103662	N° 3 8X150
OU103664	N° 4 10X200

photos non contractuelles

TOURNEVIS PHILLIPS LAME DECOLLETEE



RÉF. ART.	DESCRIPTION
OU103658	4X75
OU103659	5X100
OU103661	6X125
OU103663	8X150

TOURNEVIS PLAT LAME DECOLLETEE



RÉF. ART.	DESCRIPTION
OU103656	10X150
OU103646	2X70
OU103648	3X100
OU103650	4X120
OU103653	5,5X100
OU103652	5,5X150
OU103654	6,5X150
OU103655	8X150

TOURNEVIS PLAT ISOLE CEI



RÉF. ART.	DESCRIPTION
OU103647	3 X 100MM
OU103649	3,5 X 100MM
OU103651	4 X 100MM

TOURNEVIS PZ LAME DECOLLETEE



RÉF. ART.	DESCRIPTION
OU103666	4X75
OU103667	5X100
OU103668	6X125
OU103669	8X150

photos non contractuelles

VIRE POTEAUX SANS MANCHE ORIENTATION 2 SENS

SIBILLE



RÉF. ART.

OU105874

SUR COMMANDE = soumis à des délais supérieurs à ceux habituels

SUR COMMANDE = SOUMIS À DES DÉLAIS SUPÉRIEURS À CEUX HABITUELS



RÉF. ART.

SUR COMMANDE

LA REPARATION, écologique et économique



RÉF. ART.

REPARATION

photos non contractuelles

TRANSPORT EXPRESS

LE SERVICE TRANSPORT EXPRESS SUR MESURE VOUS ASSURE L'ENLÈVEMENT ET LA LIVRAISON DE COLIS, PLANS, PALETTES ET HORS-GABARIT DANS LES DÉLAIS LES PLUS COURTS.



RÉF. ART.

DESCRIPTION

L.BONAVENTURE@bouygues-construction.com

Transport express

j.imboden@bouygues-construction.com

AUGE CAOUTCHOUC

VINMER



RÉF. ART.	DESCRIPTION
OU000126	10L
OU000127	25L
OU000128	35L

CHARIOT DU FINISSEUR AVEC AUGES ET TAPIS

PLATEFORME DE TRAVAIL ERGONOMIQUE, ROULANTE ET RÉGLABLE EN HAUTEUR PERMETTANT D'EFFECTUER DERS TRAVAUX DE FINITIONS (PLAQUISTES, PEINTRES, PLÂTRIERS...) - 35KG - HAUTEUR RÉGLABLE DE 100 À 145CM - LARGEUR 44CM - LONGUEUR 86 CM LIVRÉ AVEC AUGES CAOUTCHOUC 25L ET TAPIS DE CAOUTCHOUC POUR COMPARTIMENT DE STOCKAGE



RÉF. ART.	DESCRIPTION
OU005568	L.85CM L.44CM

CHARIOT DU FINISSEUR ALLEGE AVEC AUGES (Présérie)

CHARIOT DE CHANTIER PLIABLE, LÉGER ET FACILE À DÉPLACER PERMETTANT D'EFFECTUER DES TRAVAUX DE FINITION (PEINTRE, PLÂTRIER...) EN TOUTE ERGONOMIE



RÉF. ART.	DESCRIPTION
OU112951	ATTENTION : Produit en présérie INNOVATION, 10 unités Disponibles

TAPIS CAOUTCHOUC POUR CHARIOT FINISSEUR

TAPIS 39 X 51 CM ÉP. 3MM EN CAOUTCHOUC À POSER DANS COMPARTIMENT BAS DE STOCKAGE DU CHARIOT FINISSEUR



RÉF. ART.
OU007795

photos non contractuelles

BAC À GÂCHER



RÉF. ART.	DESCRIPTION
OU000171	L.165CM L.90CM

BAC À MORTIER

CRAEMER



RÉF. ART.	DESCRIPTION
OU000172	200L

CHARIOT POUR BAC À MORTIER

TELIP



RÉF. ART.
OU000535

POIGNÉE PARE-COUPS POUR POINTEROLLE

MILBOX



POUR POINTEROLLES

RÉF. ART.
OU005669

POINTEROLLE



RÉF. ART.	LONGUEUR	LARGEUR
OU003682	L. 350 MM	l. 16 MM

SEAU EN CAOUTCHOUC



RÉF. ART.	DESCRIPTION
OU004077	DE 13L

photos non contractuelles

PLATOIR CHAPISTE INOX

SOFOP TALIAPLAST



PREVOIR MANCHE OU018425

RÉF. ART.	DESCRIPTION
OU018424	120X11CM DOUBLE ROND

PLATOIR EN INOX

MONDELIN



RÉF. ART.	DESCRIPTION
OU003664	L.12CM L.28CM
OU003665	L.15CM L.48CM

PLATOIR FLAMAND BOUT ROND

MONDELIN



RÉF. ART.	DESCRIPTION
OU005671	L.550MM

SCIE À BÉTON CELLULAIRE



RÉF. ART.	DESCRIPTION	LONGUEUR
OU007053	L.700 MM	L 70 CM

TALOCHE À GRÉSER



RÉF. ART.	DESCRIPTION
OU004195	L.300MM L.140MM

TALOCHE EN ÉPONGE



RÉF. ART.	LONGUEUR
OU004196	L 33 CM

photos non contractuelles

TALOCHE EN PLASTIQUE



RÉF. ART.	LONGUEUR	LARGEUR
OU004197	L 27 CM	I 18 CM
OU004198	L 35 CM	I 18 CM
OU004199	L 42 CM	I 27 CM
OU004200	L 44 CM	I 26 CM

TRUELLE À JOINT DE BRIQUE

MILBOX



RÉF. ART.	LARGEUR
OU004529	I 10 MM
OU004530	I 12 M

TALOCHE POINTURE



RÉF. ART.	LONGUEUR	LARGEUR
OU004201	L 27 CM	I 15 CM

TRUELLE CARRÉE



RÉF. ART.	LONGUEUR
OU004532	L 22 CM

TAMIS



RÉF. ART.	DESCRIPTION	TAILLE	LARGEUR
OU004212	N° 10	T10	I 18 CM
OU004213	N° 12	T12	
OU004214	N° 16	T16	
OU004211	N° 8	T08	

TRUELLE D'ANGLE INTÉRIEUR

MILBOX



RÉF. ART.
OU004531

photos non contractuelles

TRUELLE LANGUE DE CHAT

GOUVY



RÉF. ART.	LONGUEUR
OU004534	L 16 CM

EQUERRE DE MAÇON

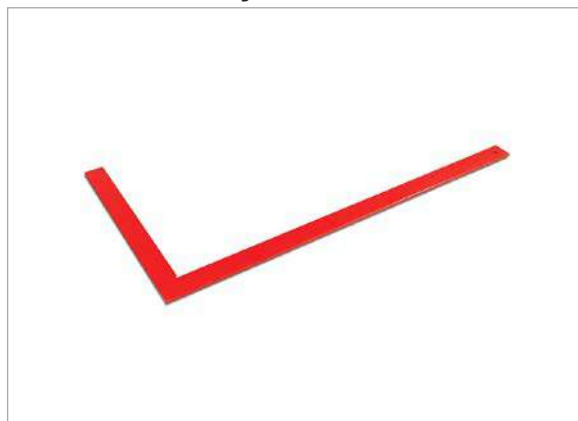

RÉF. ART.	DESCRIPTION	LONGUEUR
OU002178	L.0,6ML	L 60 CM
OU005847	L.0,8ML	L 80 CM
OU002179	L.1ML	L 100 CM

TRUELLE RONDE ITALIENNE

GOUVY



RÉF. ART.	DESCRIPTION	LONGUEUR
OU004535		L 18 CM
OU004536	SUPERIEURE	L 22 CM
OU004537		L 24 CM

BARRE D'ÉBULLAGE POUR BAP

SOFOP TALIAPLAST



POUR LISSAGE ET DEBULLAGE DU BETON AUTO-PLACANT, BARRE EN ALUMINIUM DIA 50 MM AVEC EMBOUT PLASTIQUE ET POIGNÉE ERGONOMIQUE, LONG 0,75 M, HAUTEUR REGLABLE DE 0,80 A 0,88

RÉF. ART.	DESCRIPTION	LONGUEUR
OU000212		L 75 CM
OU000213	D.50MM	L 150 CM

EPONGE DE MAÇON

VINMER



RÉF. ART.
OU002162

photos non contractuelles

BÉTONNIÈRE ÉLECTRIQUE

HAEMMERLIN



RÉF. ART.	DESCRIPTION
OU000221	BT PRO 190 180L

CHEVILLE DE MAÇON



RÉF. ART.	DESCRIPTION	LONGUEUR
OU000893	L.250MM	L 250 MM

COURROIE POUR BÉTONNIÈRES

HAEMMERLIN

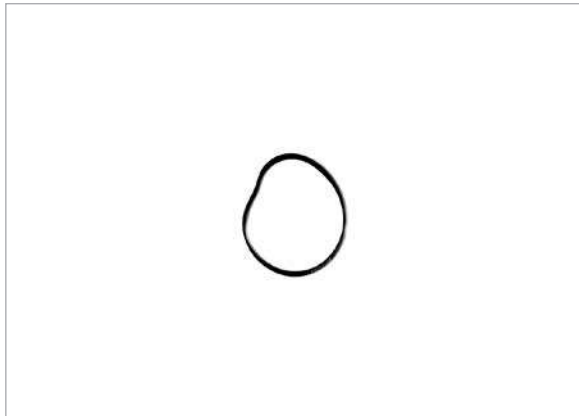

RÉF. ART.	DESCRIPTION
OU001732	PRO 190

CISEAU À BRIQUE



RÉF. ART.	DESCRIPTION	LONGUEUR
OU000901	L.70MM	L 70 MM

CHEMIN DE FER

MILBOX



RÉF. ART.
OU000549

CISEAU À PIERRE



RÉF. ART.	DESCRIPTION	LONGUEUR	LARGEUR
OU000902	L.350MM L.16MM	L 350 MM	I 70 MM

photos non contractuelles

COUPEUSE MANUELLE PRACTIC-50

RUBI FRANCE



AVEC BUTÉE LATÉRALE + ÉQUERRE 45°

RÉF. ART.	LARGEUR
OU103426	116 MM

MANCHE TELESCOPIQUE AVEC ARTICULATION ORIENTABLE

SOFOP TALIAPLAST



RÉF. ART.	DESCRIPTION
OU018425	-

FER À NEZ DE MARCHÉ EN FONTE



RÉF. ART.
OU002231

FROTTOIR POLYSTYRÈNE EXPANSÉ

VINMER



RÉF. ART.	DESCRIPTION	LONGUEUR	LARGEUR
OU009784	L.27CM L.15CM	L 27 CM	115 CM

photos non contractuelles

COUPE BOULON À BRAS FER FORGÉ

SAM OUTILLAGE



RÉF. ART.	DESCRIPTION	TAILLE
OU001519	N° 1	T01
OU001520	N° 2	T02
OU001521	N° 3	T03
OU001518	SAM N°0	T00

COUPE BOULON À BRAS TUBE

SAM OUTILLAGE



RÉF. ART.	DESCRIPTION	TAILLE
OU001522	COUPE BOULON À BRAS FER FORGÉ SAM N°4	T04
OU001524	N° 1 L.600MM	T01
OU001525	N° 2 L.750MM	T02
OU001526	N° 3 L.900MM	T03
OU001523	N° 4 SAM L.1050MM	T04

COUPE BOULON COMPACT KNIPEX

KNIPEX



RÉF. ART.
OU001527

MACHOIRE DE COUPE BOULON

SAM OUTILLAGE



RÉF. ART.	DESCRIPTION	TAILLE
OU002735	N°0	T00
OU002736	N°1	T01
OU002737	N°2	T02
OU002738	N°3	T03
OU002739	N°4	T04

GRIFFE DE FERRAILLEUR



RÉF. ART.	DESCRIPTION	LARGEUR
OU002389	D.6-8MM	106/08 MM
OU002390	D.10-12MM	110/12 MM
OU002391	D.14-16MM	114/16 MM
OU002387	RENFORCÉE D.18-20MM	118/20 MM

CISAILLES À TÔLE



RÉF. ART.	DESCRIPTION
OU000897	PCBX5

CISAILLE À BEC COUPE-TREILLIS

KNIPEX



RÉF. ART.
OU000896

LAME DE RECHANGE POUR CISAILLE À BEC COUPE TREILLIS

KNIPEX

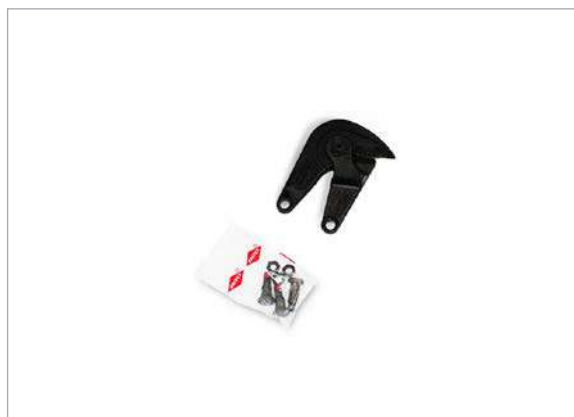

RÉF. ART.	DESCRIPTION
OU002740	AF1124

CISAILLE FER À BÉTON

REMO



RÉF. ART.	DESCRIPTION	DIAMETRE
OU000899	D.22MM	D 22 MM
OU000900	D.26MM	D 26 MM

LAME POUR CISAILLE FER À BÉTON



RÉF. ART.	DESCRIPTION
OU002623	- 22

photos non contractuelles

CINTREUSE MANUELLE

REMO



RÉF. ART.	DESCRIPTION
OU000894	DE 2 LEVIERS
OU000895	L.24MM

ERGO'APP

PÔLE ERGO BYCN

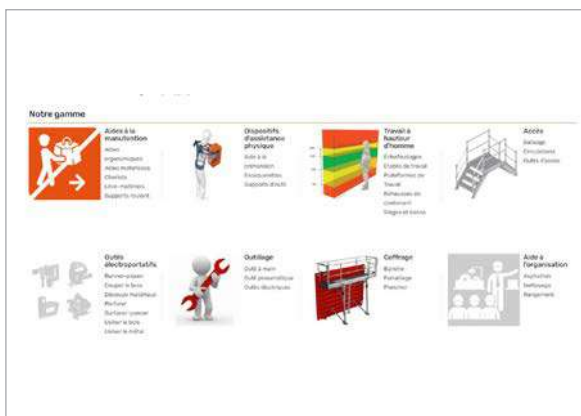

Outil d'aide à la décision permettant d'aider les collaborateurs à choisir les meilleurs outils, matériels ou

matériaux selon un besoin et un contexte. Pour chaque produit, l'app propose une carte d'identité détaillée (caractéristiques techniques, photos, liens utiles) et précise pour quel type de tâches il est destiné. Evaluation sur la base de 5 critères : Amélioration de la sécurité, Apport sur la santé, Gain de productivité Intuitivité Poids < 15 kg

RÉF. ART.	DESCRIPTION
ERGO'APP	https://ergoapp.bouygues-construction.com/?lang=fr

SOLUTION RECYCLAGE CASQUES ELECTROPORTATIFS



RÉF. ART.	DESCRIPTION
RECYCLAGE	

VERIFIEZ LA DISPONIBILITE DE NOS PRODUITS

DISTRIMO



En scannant le QR code, vérifiez le stock des produits à l'aide des références et de la barre de recherche

RÉF. ART.	DESCRIPTION
SITE WEB	http://distrimo.bouygues-construction.com/

photos non contractuelles

BARRE À MINE RONDE COUDÉE

LEBORGNE

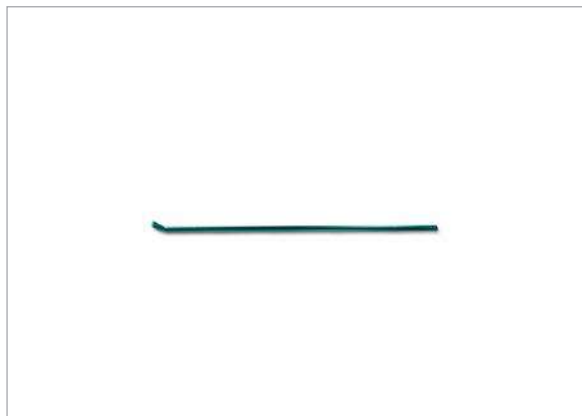

RÉF. ART.	DESCRIPTION
OU000214	L.1,5ML

BRISE GLACE



RÉF. ART.
OU000289

PINCE À RIPER LÉGÈRE

LEBORGNE

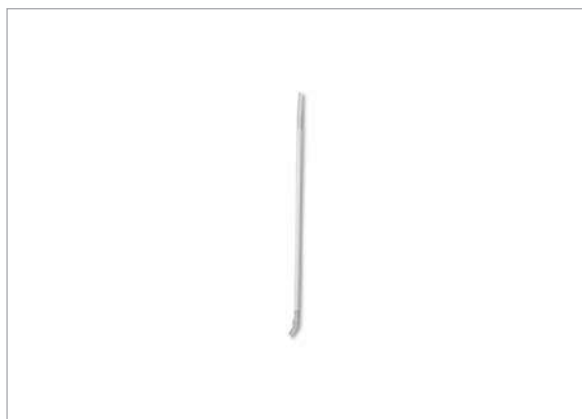

PINCE A RIPER EN COMPOSITE POUR MOINS DE POIDS

RÉF. ART.	DESCRIPTION	LONGUEUR
OU003519	LEBORGNE	L 150 CM

BURINEUR MANUEL BATIPRO

LEBORGNE



BURINEUR ADAPTE AUX TRAVAUX DEMANDANT PUISSANCE ET PRECISION

RÉF. ART.
OU000399

PINCE À TALON HEXAGONALE

SOFOP TALIAPLAST

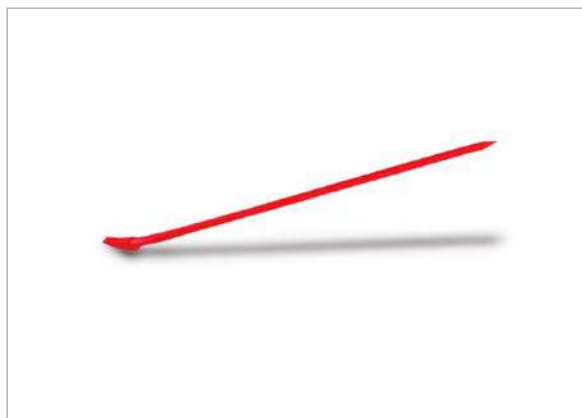

RÉF. ART.	DESCRIPTION	LONGUEUR
OU003521	L.1,50M	L 160 MM

photos non contractuelles

CLÉ DE BANCHE CODE

we love life



RÉF. ART.	DESCRIPTION	DIAMETRE
OU000906	H ROCHET TRAVERSANT - SATECO	D 36 MM
OU000907	H OCHET TRAVERSANT - B07	D 38 MM

CLÉ POUR ÉTAIEMENT (ERGONOMIQUE)

LEBORGNE

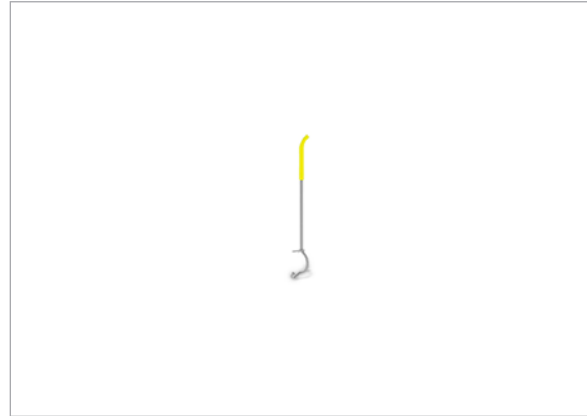

POUR SERRAGE ET DESSERRAGE DES ETAIS SANS BRUIT

RÉF. ART.
OU000999

CLÉ DE BANCHE ROCHET

we love life



RÉF. ART.	DESCRIPTION	DIAMETRE
OU000908	À JUPE B96	D 36 MM
OU000909	À JUPE PROBY	D 38 MM

RALLONGE POUR CLÉ BANCHE

we love life



RÉF. ART.	DESCRIPTION
OU003862	B07 L.90MM

DÉCOFFREUR DE PLANCHER

LEBORGNE



RÉF. ART.	DESCRIPTION	LONGUEUR
OU018136	LONGUE PORTÉE NANOVB	L 70 CM

photos non contractuelles

PINCE À DÉCOFFRER



RÉF. ART.	LONGUEUR
OU003511	L 100 CM
OU003512	

GRATTOIR DE SOL RIGIDE

PERRIN



Prévoir manche

RÉF. ART.	DESCRIPTION	LARGEUR
OU002385	L.100MM (PREVOIR MANCHE)	I 100 MM

GRATTOIR TÉLESCOPIQUE

LEBORGNE



Manche télescopique de 2m à 3,5m

RÉF. ART.	DESCRIPTION
OU010241	AVEC MANCHE L.2-3,5M

OUTIL DE RÉCUPÉRATION DES ATTACHES VOLANTES



Outil acier à mécanisme pour récupérer les attaches volantes en mur aveugle. Manche télescopique de 1,60 à 3,00m - Poids : 2,5kg

RÉF. ART.
OU008614

photos non contractuelles

RABOT A BETON MULLER



RÉF. ART.	DESCRIPTION	LONGUEUR	LARGEUR
OU007518	L.350 MM (PREVOIR MANCHE OU002763)	L 150 CM	I 350 MM

RACLOIR DE BANCHE LEBORGNE

LEBORGNE



RÉF. ART.	DESCRIPTION	LONGUEUR
OU003789	L.300MM (PREVOIR MANCHE OU002758)	L 180 CM

MANCHE DE GRATTOIR MULLER

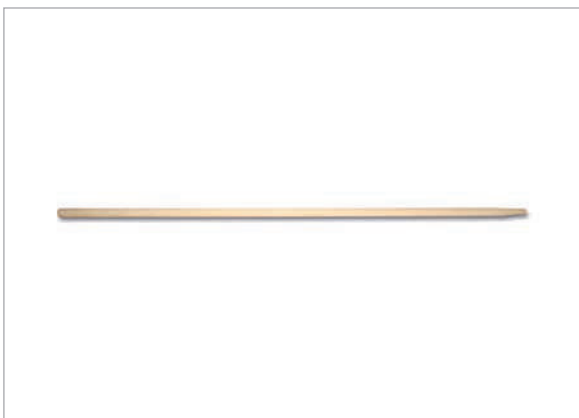

RÉF. ART.	DESCRIPTION
OU002763	MANCHE DE GRATTOIR BOIS L.1,50M

MANCHE POUR RACLOIR DE BANCHE LEBORGNE



RÉF. ART.	DESCRIPTION	LONGUEUR
OU002758	MANCHE GRATTOIR BOIS L.1,80M (PREVOIR RACLOIR AH113)	L 76 CM

RACLOIR DE BANDE MULLER

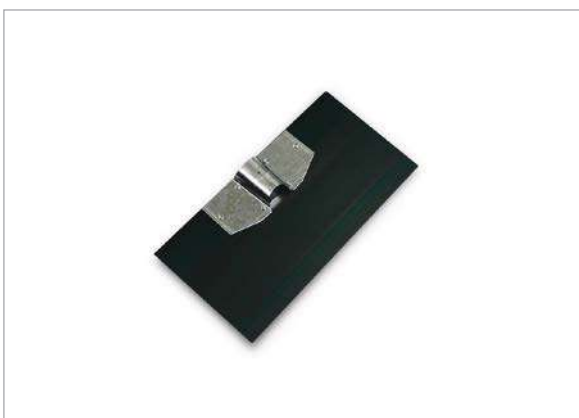

RÉF. ART.	DESCRIPTION	LARGEUR
OU005743	L.300 MM (PREVOIR MANCHE OU002763)	I 300 MM

photos non contractuelles

SCIE À BÛCHE DENTURE AMERICAINE



RÉF. ART.
OU008047

SCIE À MAIN

STARRETT



RÉF. ART.	DESCRIPTION
OU004058	L.300MM POUR PVC
OU004059	L.450MM POUR PVC

SCIE À GUICHET POUR PLAQUE DE PLATRE



RÉF. ART.
OU103422

SCIE À MÉTAUX

SAM OUTILLAGE



RÉF. ART.	DESCRIPTION	LONGUEUR
OU004060	POIGNÉE RÉVOLVER	L 50 CM

SCIE ÉGOÏNE À DENT



RÉF. ART.	DESCRIPTION	LONGUEUR
OU007054	FINE PCBX12	L 60 CM
OU007050	GROSSE PCBX12	L 300 MM

photos non contractuelles

LAME DE RECHANGE POUR SCIE PVC

STARRETT



RÉF. ART.	DESCRIPTION	LONGUEUR
OU002523	L.450MM	L 450 MM
OU002524		L 76 CM

MONTURE DE SCIE À MÉTAUX

STARRETT



RÉF. ART.
OU003254

LAME DE SCIE À BÛCHES



RÉF. ART.	DESCRIPTION
OU008048	DENT. AMER. 0,76M

COUPE CARREAUX MANUEL PRO CC1300

SIDAMO



RÉF. ART.	DESCRIPTION	REFERENCE FABRICANT
OU108103	AVEC HOUSSE DE TRANSPORT	20116193

LAME DE SCIE À MÉTAUX

STARRETT



RÉF. ART.
OU002526

SERPE PARIS

MULLER GOUVY SERMAX



RÉF. ART.	LONGUEUR
OU103427	L 30 CM

photos non contractuelles

BOITE À ONGLET



RÉF. ART.	DESCRIPTION
OU000231	L.300MM

CISEAU À BOIS



RÉF. ART.	DESCRIPTION
OU007047	BI-MATIÈRE 30/122
OU007049	MANCHE BIMATIÈRE JEU 6/10/12/16/20/26 pcb de 8

CROISSANT D'ELAGAGE



RÉF. ART.	DESCRIPTION
OU103428	MANCHE BOIS 130CM

ÉQUERRE DE MENUISIER



RÉF. ART.	LONGUEUR
OU002180	L 30 CM
OU002181	L 40 CM

FAUSSE EQUERRE

MULLER GOUVY SERMAX



RÉF. ART.
OU002224

HACHETTE DE CHARPENTIER



RÉF. ART.	DESCRIPTION
OU007739	800GR

photos non contractuelles

COFFRE D'ASPIRATEUR

COFFRE ASPIRATEUR VERSION 2 PORTES LATÉRALES AVEC PERCHE ET ENROULEUR. COFFRE MOBILE DE MENUISERIE POUR CONTENIR UN ASPIRATEUR, UN ENROULEUR ÉLECTRIQUE ET UNE MALETTE DE SCIE - 4 POINTS DE LEVAGE - PÉDALE FREIN - POERCHE TÉLESCOPIQUE AVEC ENROULEUR POUR TUYAU - 1 REPOSE SCIE - DIMENSIONS : 66 X 104 X 110 CM - POIDS : 56KG - CMU : 100KG - SUR COMMANDE



RÉF. ART.	DESCRIPTION
OU009912	VERSION 2 PORTES LATÉRALES

PERCHE POUR COFFRE D'ASPIRATEUR

POTENCE QUI S'ADAPTE SUR LES COFFRES ASPIRATEURS V1 (COFFRE OUVRANT D'EN HAUT) OU V2 (PORTES LATÉRALES)



RÉF. ART.	DESCRIPTION
OU009914	

ENROULEUR DE TUYAU ASPIRATEUR POUR COFFRE ASPIRATEUR

S'ADAPTE SUR LES COFFRES ASPIRATEURS V1 (COFFRE OUVRANT D'EN HAUT) OU V2 (PORTES LATÉRALES)



RÉF. ART.	DESCRIPTION
OU009913	

VERIFIEZ LA DISPONIBILITE DE NOS PRODUITS

DISTRIMO



En scannant le QR code, vérifiez le stock des produits à l'aide des références et de la barre de recherche

RÉF. ART.	DESCRIPTION
SITE WEB	http://distrimo.bouygues-construction.com/

photos non contractuelles

PELLE ALSACE

LEBORGNE



RÉF. ART.	DESCRIPTION
OU103507	MANCHE POLYAMIDE CINTRE

PELLE TÔLE CURETTE

LEBORGNE



RÉF. ART.	DESCRIPTION
OU103423	19CM EMMANCHEE

PELLE CARREE DE 25

GOUVY



RÉF. ART.	DESCRIPTION	LARGEUR
OU003459	(PRÉVOIR MANCHE)	125 CM

PELLE À NEIGE OU BAP AVEC MANCHE



RÉF. ART.
OU003458

PELLE RONDE

GOUVY



RÉF. ART.	DESCRIPTION	LARGEUR
OU003462	DE 27 (PRÉVOIR MANCHE)	127 CM
OU003463	DE 29 (PRÉVOIR MANCHE)	129 CM

PIOCHE DE TERRASSIER



RÉF. ART.	DESCRIPTION
OU003550	2,5KG (PREVOIR MANCHE AH205 OU AH208)

photos non contractuelles

RÂTEAU À CAILLOUTIS 14 DENTS

MERCIER



RÉF. ART.	DESCRIPTION
OU003869	(PREVOIR MANCHE)

MANCHE DE PELLE

GOUVY



RÉF. ART.	DESCRIPTION
OU002770	L.1,10M

RATEAU À CULTURE 14 DENTS CINTRÉES

MERCIER



RÉF. ART.	DESCRIPTION
OU003870	(PREVOIR MANCHE)

MANCHE DE PIOCHE

GOUVY



RÉF. ART.	DESCRIPTION
OU002771	BOIS
OU002772	FIBRE DE VERRE

RATEAU RENFORCÉ À BÉTON

GOUVY



RÉF. ART.	DESCRIPTION	LONGUEUR
OU007732	(PREVOIR MANCHE)	L 110 CM

MANCHE DE RATEAU

GOUVY

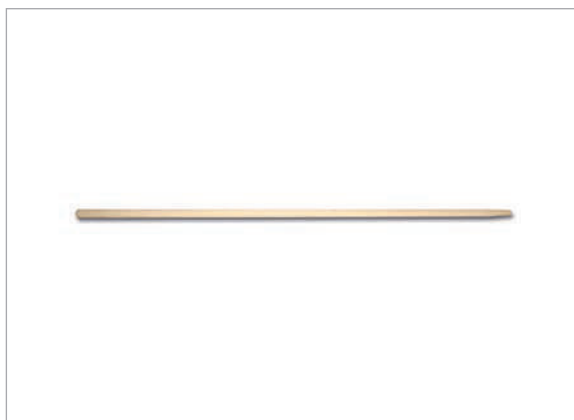

RÉF. ART.	DESCRIPTION
OU002773	BOIS

photos non contractuelles

CROC À BÉTON 4 DENTS

PRÉVOIR MANCHE

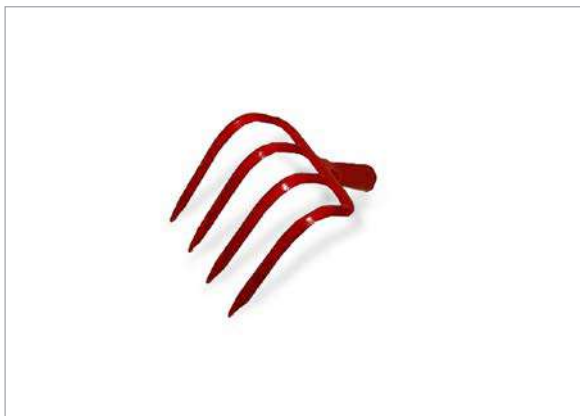

RÉF. ART.	DESCRIPTION
OU001766	(PREVOIR MANCHE)

ARROSOIR EN ACIER GALVANISÉ



RÉF. ART.	DESCRIPTION
OU005567	13L

DAME À MAIN 18 X 18 CM

LEBORGNE



RÉF. ART.	DESCRIPTION
OU001786	5KG ENROBES

LOUCHET TERRASSIER

LEBORGNE



RÉF. ART.	DESCRIPTION
OU103443	36 NOVAGRIP BT

RACLETTE À BITUME BOIS ENROBÉE

SOFOP TALIAPLAST

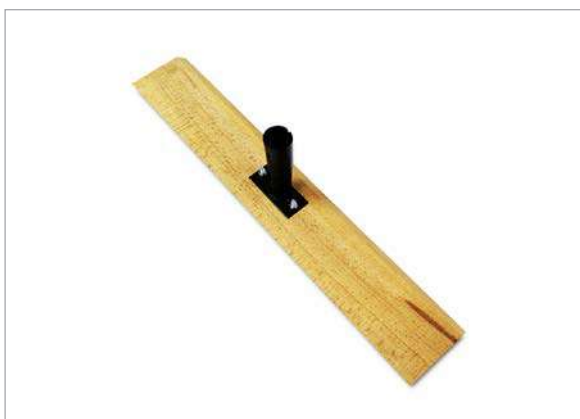

RÉF. ART.	DESCRIPTION
OU003786	L.55x10CM (PREVOIR MANCHE)
OU003787	L.57x7,5CM (PREVOIR MANCHE)

photos non contractuelles

COUPEAU À ENDUIRE INOX MANCHE BI-MATIÈRE

MILBOX



RÉF. ART.	LARGEUR
OU001738	1100 MM
OU001739	1120 MM
OU001740	1140 MM
OU001741	1160 MM
OU001742	1180 MM
OU001743	1200 MM
OU001744	1220 MM

COUPEAU À ENDUIRE

MILBOX



RÉF. ART.	LARGEUR
OU001735	140 MM
OU001736	160 MM
OU001737	180 MM

COUPEAU DE PEINTRE

MILBOX



RÉF. ART.	DESCRIPTION	LARGEUR
OU005667	L.50MM	150 MM

RIFLARD EMBASE

MILBOX



RÉF. ART.	DESCRIPTION	LARGEUR
OU003900	L.70MM	170 MM

SCEAU À PEINTURE

MILBOX



RÉF. ART.
OU005845

photos non contractuelles

GRIFFE MÉTALLIQUE POUR SEAU DE PEINTURE

MILBOX



RÉF. ART.
OU005844

MANCHON CLIP ANTI-GOUTTE

MILBOX



RÉF. ART.	DESCRIPTION	LARGEUR
OU002788	EN LAINE	1180 MM
OU002789	EN MOUSSE	1180 MM

MONTURE CLIPS POUR ROULEAU

MILBOX



RÉF. ART.	DESCRIPTION
OU003253	180MM

MANCHON MOUSSE DE LAPIN EN LAINE

MILBOX



RÉF. ART.
OU002799

MONTURE DE PATTE DE LAPIN DE 40

MILBOX



RÉF. ART.	LARGEUR
OU003255	140 MM

MANCHON PATTE DE LAPIN EN LAINE

MILBOX



RÉF. ART.	DESCRIPTION
OU002797	40mm

photos non contractuelles

PINCEAU À BADIGEON

MILBOX



RÉF. ART.	TAILLE
OU003539	T04

PINCEAU QUEUE DE MORUE

MILBOX



RÉF. ART.	TAILLE	LARGEUR
OU003542		120 MM
OU003543		140 MM
OU003544		150 MM
OU003545		160 MM
OU003546		170 MM
OU003541	T02	100 MM

PINCEAU À RECHAMPIR

MILBOX



RÉF. ART.	DESCRIPTION	TAILLE
OU003537	N°4	T06
OU003538	N°6	

PINCEAU ROND

MILBOX



RÉF. ART.	DESCRIPTION	TAILLE
OU003547	N°2	T04
OU003548	N°4	T08
OU003549	N°8	

PINCEAU COUDÉ POUR RADIATEUR

MILBOX



RÉF. ART.
OU003540

photos non contractuelles

CALE PLAQUE À LEVIER

TALIAPLAST

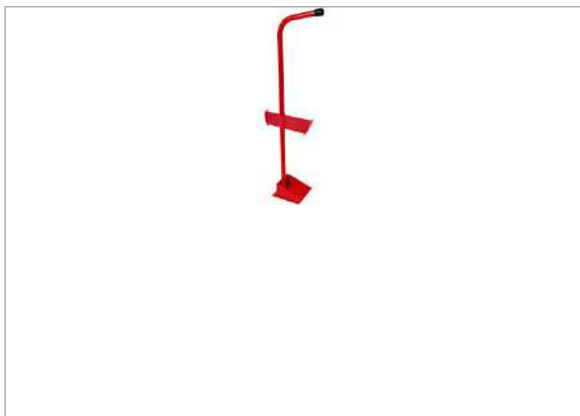

RÉF. ART.	DESCRIPTION
OU103445	CALE PLAQUE A LEVIER 80CM

LEVE PLAQUE TALIATOP

TALIAPLAST



RÉF. ART.	DESCRIPTION
PO103444	MULTI++ 2 TABLETTES

photos non contractuelles

CLE DE FONTAINIER 1,50M



RÉF. ART.	DESCRIPTION
OU103430	CARRE 32MM

COFFRET PINCE A EMBOITURE



RÉF. ART.	DESCRIPTION
OU103441	3/8-1/2-5/8-3/4-7/8-1.1.1/8"

CONTROLEUR D'ETANCHEITE GAZ 60 MBAR

MOINEAU



RÉF. ART.
OU103442

COUPE TUBE



RÉF. ART.	DESCRIPTION	REFERENCE FABRICANT
OU103431	ACIER STANDARD 1/8' A 1' 1/4	
OU103432	FONTE GRISE 8 MOLETTES 76-150 MM	
OU103433	FONTE GRISE 9 MOLETTES 125-260MM	
OU103434	COUPE-TUBE INOX ZR 35 3-35 MM	
OU103435	COUPE-TUBE PLASTIQUE PC 32 32 MM	
OU112962	GUILLOTINE N°2 - DIAM MAX 225	211522

DUDGEONNIERE STANDARD VIRAX



Ext. Tube : 1/8* - 3/16 - 1/4 - 5/16 - 3/8 - 7/16* - 1/2 - 5/8 - 3/4

RÉF. ART.
OU103440

photos non contractuelles

EBAVUREUR ALU INT/EXT MILTIMAT

virax



RÉF. ART.	DESCRIPTION
OU103437	DIAM 35
OU103438	DIAM 56

EBAVUREUR TONNEAU

virax



RÉF. ART.	DESCRIPTION
OU103436	DIAM 6 A 42MM

PINCE COUPE TUBE

SAM OUTILLAGE



RÉF. ART.	DESCRIPTION
OU020743	42MM
OU103451	PVC 63MM

CINTREUSE ARBALETE

virax



RÉF. ART.	DESCRIPTION
OU103439	3/8' - 1/2' - 5/8' - 3/4' - 7/8'

photos non contractuelles

LAMPE À SOUDER

LIVRÉ SANS CARTOUCHE - REF CARTOUCHE : AB1311



RÉF. ART.	DESCRIPTION
OU002680	SANS CARTOUCHE

CHALUMEAU SOUDEUR PIROSAF 1000



RÉF. ART.
OU000518

CARTOUCHE DE GAZ BUTANE

POUR LAMPE A SOUDER PRIMERA



RÉF. ART.	DESCRIPTION
CO004951	190G/345ML POUR LAMPE PRIMERA

ALLUME GAZ À COUPELLE



RÉF. ART.
OU000063

CHALUMEAU DÉCOUPEUR ALCOPT G1



RÉF. ART.	DESCRIPTION
OU000517	ref 7800-0001

ENSEMBLE FLAMME AIRLIQUIDE OXYFLAM 500 EQUIPE



RÉF. ART.
OU103455

photos non contractuelles

POSTE À SOUDER PORTABLE SAF PRESTO



POUR SOUDURE ELECTRIQUE BAGUETTE 2 à 3 MM

RÉF. ART.	DESCRIPTION
OU005341	190 GC PACK

POSTE À SOUDER PRESTO



POUR SOUDURE ELECTRIQUE BAGUETTE 2 à 4 MM

RÉF. ART.	DESCRIPTION
OU005343	160G 230 50,6 HZ 7KG
OU005342	165 G PACK 165A 230V 13KG

TUYAU ACÉTYLÈNE 10/20 EN COURONNE



RÉF. ART.	DESCRIPTION	DIAMETRE
OU005803	L.10M	D 10/20 MM

TUYAU OXYGÈNE



RÉF. ART.	DESCRIPTION	DIAMETRE
CO004568	10/20 EN COURONNE L.10M	D 10/20 MM
CO005804	AD 10ML ÉQUIPE ANTI-RETOUR, MANCHETTE 50CM	

CHARIOT PORTE-BOUTEILLE ACÉTYLÈNE + OXYGÈNE



RÉF. ART.	DESCRIPTION
OU000538	9 M3

photos non contractuelles

CLÉ À CLIQUET RÉVERSIBLE

SAM OUTILLAGE



RÉF. ART.	DESCRIPTION
OU000910	STANDARD D.1/2"
OU000911	STANDARD D.3/4" (MANCHE AC1901)

CLÉ À MOLETTE SATINÉE

SAM OUTILLAGE



RÉF. ART.	DESCRIPTION
OU000919	OUVERTURE DE 25
OU000920	OUVERTURE DE 30
OU000921	OUVERTURE DE 35
OU000922	OUVERTURE DE 45
OU000923	OUVERTURE DE 55
OU000924	OUVERTURE DE 70

CLE A FOURCHE SIMPLE

KNIPEX



RÉF. ART.	DESCRIPTION
OU010558	ISOLEE OUVERTURE 10MM

CLÉ À PIPE

SAM OUTILLAGE



RÉF. ART.	DESCRIPTION
OU002465	D.8-22MM - JEU DE 8

CLÉ A GRIFFE

SAM OUTILLAGE



RÉF. ART.	DESCRIPTION
OU000918	CLÉ À GRIFFE DE 60
OU930003	CLE A GRIFFE DE 75 (CLE STILLSON 24")

photos non contractuelles

CLE A PIPE DEBOUCHEE

FACOM



RÉF. ART.	DESCRIPTION
OU000952	- Ø 36

CLÉ MÂLE

SAM OUTILLAGE



RÉF. ART.	DESCRIPTION
OU002459	6 PANS D.1,5-12CM - JEU DE 12
OU002469	COURTE 6 PANS
OU002467	LONGUE SPHÉRIQUES 6 PANS D.1,5-10MM - JEU DE 9
OU002466	TORX T8 À T40 D.2,3-6,4MM - JEU DE 8

CLÉ MIXTE À CLIQUET

SAM OUTILLAGE



RÉF. ART.	DESCRIPTION	REFERENCE FABRICANT
OU103505	EN MM 8	
OU103506	EN MM 9	
OU103497	EN MM 10	
OU020931	EN MM 11	50-C-11
OU020932	EN MM 12	50-C-12
OU103498	EN MM 13	
OU020933	EN MM 14	50-C-14
OU103499	EN MM 15	
OU020935	EN MM 16	50-C-16
OU103500	EN MM 17	
OU103501	EN MM 18	
OU103502	EN MM 19	
OU020937	EN MM 21	50-C-21
OU103503	EN MM 22	
OU103504	EN MM 24	

photos non contractuelles

CLÉ MIXTE

SAM OUTILLAGE



RÉF. ART.	DESCRIPTION	DIAMETRE
OU000960		D 06 MM
OU000961		D 07 MM
OU000962		D 08 MM
OU000963		D 09 MM
OU000964		D 10 MM
OU000965		D 11 MM
OU000966		D 12 MM
OU000967		D 13 MM
OU000968		D 14 MM
OU000969		D 15 MM
OU000970		D 16 MM
OU000971		D 17 MM
OU000972		D 18 MM
OU000973		D 19 MM
OU000974		D 20 MM
OU000975		D 21 MM
OU000976		D 22 MM
OU000977		D 23 MM
OU000978		D 24 MM
OU000979		D 25 MM
OU000980		D 26 MM
OU000981		D 27 MM
OU000982		D 28 MM
OU000983		D 29 MM
OU000984		D 30 MM
OU000985		D 32 MM
OU000986	CLE MIXTE	D 35MM
OU000987		D 36 MM
OU000989		D 46 MM

CLÉ MULTIFONCTION TWINKEY

KNIPEX



clé multifonctionnelle pour l'actionnement des fermetures depuis les zones techniques des bâtiments (chauffage et sanitaire, technique de

climatisation et de ventilation, électrotechnique), alimentation en gaz et en eau et systèmes d'arrêt - version à 8 jets: 2 clés cruciformes reliées au moyen d'aimants avec

économie de place - embout réversible: fente 1,0 x 7 mm et fente cruciforme PH 2 - clé et embout réversible accouplés par un fil métallique robuste en

acier inoxydable - construction en

RÉF. ART.
OU008587

CLÉ PLATE

SAM OUTILLAGE



RÉF. ART.	DESCRIPTION
OU000992	D.10MM À 11MM
OU000993	D.12MM À 14MM
OU000994	D.22MM À 24MM

CLÉ PLATE MIXTE

SAM OUTILLAGE



RÉF. ART.	DESCRIPTION
OU002460	CLÉ PLATES MIXTE D.8-22MM - JEU DE 12

CLÉS À FOURCHES

SAM OUTILLAGE



RÉF. ART.	DESCRIPTION
OU103489	EN MM 8X10
OU103464	EN MM 10X11
OU103465	EN MM 11X13
OU103466	EN MM 12X13
OU103467	EN MM 14X15
OU103468	EN MM 16X17
OU103469	EN MM 17X19
OU103470	EN MM 18X19
OU103471	EN MM 20X21
OU103472	EN MM 20X22
OU103473	EN MM 21X23
OU103474	EN MM 24X26

CLÉ POLYGONALE À FRAPPER

SAM OUTILLAGE



POUR DESSERAGE A LA MASSE AVANT DESSERAGE PAR CLE A CLIQUET

RÉF. ART.	DIAMETRE
OU000995	D 36 MM
OU000996	D 38 MM
OU000997	D 42 MM
OU000998	D 48 MM

photos non contractuelles

CLÉS À PIPE DÉBOUCHÉES

SAM OUTILLAGE



RÉF. ART.	DIAMETRE
OU000925	D 06 MM
OU000926	D 07 MM
OU000927	D 08 MM
OU000928	D 09 MM
OU000929	D 10 MM
OU000930	D 11 MM
OU000931	D 12 MM
OU000932	D 13 MM
OU000933	D 14 MM
OU000934	D 15 MM
OU000935	D 16 MM
OU000936	D 17 MM
OU000937	D 18 MM
OU000938	D 19 MM
OU000939	D 20 MM
OU000940	D 21 MM
OU000941	D 22 MM
OU000942	D 23 MM
OU000943	D 24 MM
OU000944	D 25 MM
OU000945	D 26 MM
OU000946	D 27 MM
OU000947	D 28 MM
OU000948	D 29 MM
OU000949	D 30 MM
OU000950	D 31 MM
OU000951	D 32 MM

CLÉS À PIPE NON DÉBOUCHÉE

SAM OUTILLAGE



RÉF. ART.	DESCRIPTION	DIAMETRE
OU000953	D.36MM	D 36 MM

CLÉS À SIMPLE FOURCHE PUISSANTE

SAM OUTILLAGE



RÉF. ART.	DESCRIPTION
OU103529	EN MM 42

CLÉS DYNAMO DYNATECH PR EMBOUTS RECTANGULAIRES

SAM OUTILLAGE



+ CLIQUET 1/2

RÉF. ART.	DESCRIPTION
OU103603	20-100NM

photos non contractuelles

CLÉS DYNAMO ÉLECTRONIQUES DYNALIGHT C PR EMBOUTS RECTANG.

SAM OUTILLAGE



ATT 9X12

RÉF. ART.

OU103602

CLÉS MÂLES 6 PANS À TÊTE SPHÉRIQUE

SAM OUTILLAGE



RÉF. ART. DESCRIPTION

OU103520	EN MM 1,5
OU103522	EN MM 2
OU103523	EN MM 2,5
OU103524	EN MM 3
OU103525	EN MM 4
OU103526	EN MM 5
OU103527	EN MM 6
OU103528	EN MM 8
OU103521	EN MM 10

CLÉS MÂLES DROITES EMMANCHÉES

SAM OUTILLAGE



RÉF. ART. DESCRIPTION

OU103512	S1 MM 2
OU103511	S1 MM 2,5
OU103513	S1 MM 3
OU103514	S1 MM 4
OU103515	S1 MM 5
OU103516	S1 MM 6
OU103517	S1 MM 7
OU103518	S1 MM 8
OU103519	S1 MM 9
OU103510	S1 MM 10

CLÉS POLYGONALES À CLIQUET

SAM OUTILLAGE



RÉF. ART. DESCRIPTION

OU103485	EN MM 12X13
OU103486	EN MM 16X18
OU103487	EN MM 17X19
OU103488	EN MM 22X24

photos non contractuelles

CLÉS POLYGONALES À TUYAUTER 12 PANS

SAM OUTILLAGE



RÉF. ART.	DESCRIPTION
OU103463	EN MM 8X9
OU103459	EN MM 10X11
OU103460	EN MM 12X13
OU103461	EN MM 14X16
OU103462	EN MM 17X19

CLÉS POLYGONALES CONTRE-COUDÉES

SAM OUTILLAGE



RÉF. ART.	DESCRIPTION
OU103484	EN MM 8X9
OU103475	EN MM 10X11
OU103476	EN MM 12X13
OU103477	EN MM 14X15
OU103478	EN MM 16X17
OU103479	EN MM 18X19
OU103480	EN MM 19X22
OU103481	EN MM 20X22
OU103482	EN MM 21X23
OU103483	EN MM 22X24

CLIQUET "PAUME DE MAIN"

FACOM

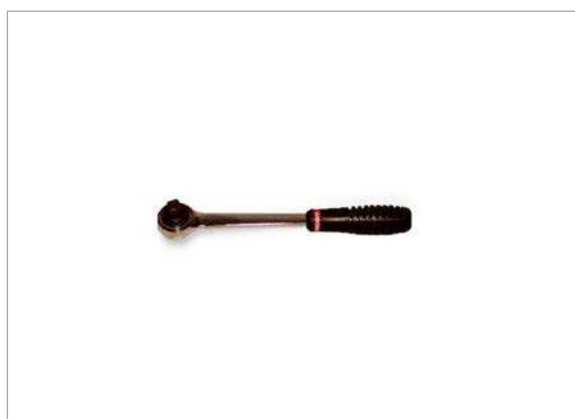

RÉF. ART.	DESCRIPTION
OU001010	S161 D.39MM L.250MM

CLIQUET 1/2"

SAM OUTILLAGE



RÉF. ART.	DESCRIPTION
OU000229	23 OUTILS D.10 A 32MM

CLIQUET 1/2" ARTICULÉ

SAM OUTILLAGE



RÉF. ART.
OU103849

photos non contractuelles

CLIQUET 3/8" ISOLÉ 1000V

SAM OUTILLAGE



RÉF. ART.
OU103883

CLIQUET COMPACT 3/4

FACOM



RÉF. ART.	DESCRIPTION
OU001011	K152 D.19MM L.505MM

CLIQUET EMMANCHÉ C151

SAM OUTILLAGE



RÉF. ART.
OU001014

COFFRET À CLIQUET + DOUILLES 1/2" POUR SERVANTE

SAM OUTILLAGE



RÉF. ART.
OU000232

EMBOUS RECTANGULAIRES À FOURCHE DÉPORTÉE

SAM OUTILLAGE



RÉF. ART.	DESCRIPTION
OU103598	9X12 MM 17MM

JEU DE 9 CLES MIXTES 8 A 19

SAM OUTILLAGE



RÉF. ART.
OU002468

photos non contractuelles

MANCHE DE CLÉ À CLIQUET 3/4

SAM OUTILLAGE



RÉF. ART.
OU002762

VALISE TEXTILE 27 OUTILS

SAM OUTILLAGE



RÉF. ART.
OU017150

RALLONGE CLIQUET 3/4 L.196MM

SAM OUTILLAGE



RÉF. ART.
OU003850

TRANSPORT EXPRESS

LE SERVICE TRANSPORT EXPRESS SUR MESURE VOUS ASSURE L'ENLÈVEMENT ET LA LIVRAISON DE COLIS, PLANS, PALETTES ET HORS-GABARIT DANS LES DÉLAIS LES PLUS COURTS.



RÉF. ART.	DESCRIPTION
Transport express	L.BONAVENTURE@bouygues-construction.com j.imboden@bouygues-construction.com

RÂTELIER DE 9 CLÉS MÂLES RESISTORX®

SAM OUTILLAGE



RÉF. ART.
OU103509

Une idée de nouveau produit ?



RÉF. ART.	DESCRIPTION
NOUVEAU PRODUIT	mailto:t.bobin@bouygues-construction.com

photos non contractuelles

DOUILLE 3/4" 12 PANS

SAM OUTILLAGE



RÉF. ART.	DESCRIPTION	DIAMETRE
OU001909		D 22 MM
OU001911		D 24 MM
OU001913		D 26 MM
OU001923		D 28 MM
OU001915	DOUILLE 3/4" 12 PANS	D 30 MM
OU001917		D 32 MM
OU001918		D 36 MM
OU001919		D 38 MM
OU001920		D 46 MM

DOUILLE 1/2 - 6 PANS

SAM OUTILLAGE



RÉF. ART.	DIAMETRE
OU103878	D 8 MM
OU103879	D 9 MM
OU103858	D 10 MM
OU103859	D 11 MM
OU103860	D 12 MM
OU103861	D 13 MM
OU103862	D 14 MM
OU103863	D 15 MM
OU103864	D 16 MM
OU103865	D 17 MM
OU103866	D 18 MM
OU103867	D 19 MM
OU103868	D 20 MM
OU103869	D 21 MM
OU103870	D 22 MM
OU103871	D 23 MM
OU103872	D 24 MM
OU103873	D 25 MM
OU103874	D 26 MM
OU103875	D 27 MM
OU103876	D 30 MM
OU103877	D 32 MM

photos non contractuelles

DOUILLE 1/2 - 12 PANS

SAM OUTILLAGE



RÉF. ART.	DIAMETRE
OU001884	D 08 MM
OU001886	D 10 MM
OU001888	D 12 MM
OU001889	D 13 MM
OU001890	D 14 MM
OU001891	D 15 MM
OU001892	D 16 MM
OU001893	D 17 MM
OU001894	D 18 MM
OU001895	D 19 MM
OU001896	D 20 MM
OU001897	D 21 MM
OU001898	D 22 MM
OU001900	D 24 MM
OU001906	D 30 MM
OU001908	D 32 MM

DOUILLE 3/4 - 6 PANS

RÉF. ART.	DIAMETRE
OU001910	D 22 MM
OU001912	D 24 MM
OU001914	D 26 MM

DOUILLE 6 PANS 1/4

RÉF. ART.	DESCRIPTION
OU001922	R2NANO

DOUILLE COURTE 3/4

RÉF. ART.	DESCRIPTION	DIAMETRE
OU001924	" D.36MM 12 PANS	D 36 MM

photos non contractuelles

DOUILLE 1/2" 12 PANS

SAM OUTILLAGE



RÉF. ART.	DESCRIPTION	DIAMETRE
OU001885		D 09 MM
OU001887		D 11 MM
OU001899		D 23 MM
OU001901		D 25 MM
OU001902	DOUILLE 1/2" 12 PANS	D 26 MM
OU001903		D 27 MM
OU001904		D 28 MM
OU001905		D 29 MM
OU001907		D 31 MM

DOUILLES COURTES 3/8" ISOLÉES

SAM OUTILLAGE



RÉF. ART.	DESCRIPTION
OU103884	1000V MM 10
OU103885	1000V MM 13
OU103886	1000V MM 17

DOUILLES TOURNEVIS COURTES 1/2 6 PANS

SAM OUTILLAGE

Douilles tournevis courtes 1/2" Monobloc pour empreintes 6 pans

RÉF. ART.	DESCRIPTION
OU103855	CREUX 6
OU103856	CREUX 7
OU103857	CREUX 8
OU103850	CREUX 10
OU103851	CREUX 12
OU103852	CREUX 14
OU103853	CREUX 17
OU103854	CREUX 19

EMBOUTS RECTANGULAIRES CLIQUET 1/2

SAM OUTILLAGE



RÉF. ART.	DESCRIPTION
OU103601	RÉVERSIBLE 9X12 MM

RALLONGE DE DOUILLE

SAM OUTILLAGE



RÉF. ART.
OU003851

photos non contractuelles

CANTINE MÉTALLIQUE



RÉF. ART.	DESCRIPTION	LONGUEUR	LARGEUR	EPAISSEUR
OU000474	70L	L 700 MM	I 370 MM	H 290 MM
OU000475	225L	L 970 MM	I 570 MM	H 410 MM

COFFRE DE CHANTIER MOBILE
BARROBOX BB2

ARMORGARD



RÉF. ART.	DESCRIPTION	LON- GUEUR	LAR- GEUR	H	REFERENCE FABRICANT
OU018298	COFFRE DE CHANTIER MOBILE 740 X 1095 X 720MM BARROBOX BB2	L 1095 MM	I 740 MM	H 720 MM	BB2

COFFRE DE CHANTIER MÉTALLIQUE



RÉF. ART.	LONGUEUR	LARGEUR	EPAISSEUR
OU001170	L 1200 MM	I 800 MM	H 830/520 MM
OU001171	L 1900 MM	I 830 MM	H 830/520 MM
OU001172	L 670 MM	I 350 MM	H 350 MM
OU005762	L 850 MM	I 350 MM	H 350 MM

COFFRE DE CHANTIER TUFFBANK TB2

ARMORGARD



RÉF. ART.	DESCRIPTION	LON- GUEUR	LAR- GEUR	H	REFERENCE FABRICANT
OU018297	COFFRE DE CHANTIER 1275 X 665 X 660MM TUFFBANK TB2	L 1275 MM	I 665 MM	H 660 MM	TB2

photos non contractuelles

COFFRE DE CAMIONNETTE TUFFBANK TB1

ARMORGARD



RÉF. ART.	DESCRIPTION	LON- GUEUR	LAR- GEUR	H	REFERENCE FABRICANT
OU018296	COFFRE DE CAMIONNETTE 980 X 540 X 475MM TUFFBANK TB1	L 980 MM	L 540 MM	H 475 MM	TB1

ROULETTES 6 " ET KIT DE FIXATION POUR COFFRE ARMORGARD

ARMORGARD



RÉF. ART.	REFERENCE FABRICANT
OU018309	CAS

SAC A OUTIL

HILTI



434910

RÉF. ART.	DESCRIPTION	LON- GUEUR	LAR- GEUR	EPAIS- SEUR	REFERENCE FABRICANT
EL014778	PETIT (LxH): 400 x 340 x 300 mm				434910
EL010408	S GRAND -2008518	L 560 MM	L 360 MM	H 370 MM	2008518

VALISE DE 131 OUTILS

TOOL FRANCE

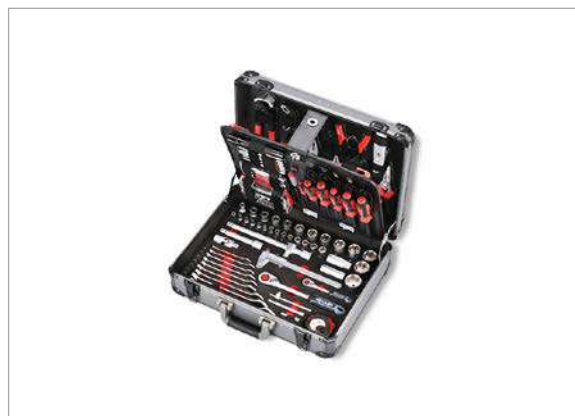

RÉF. ART.
OU004569

photos non contractuelles

BOITE À OUTIL MÉTALLIQUE 5 COMPARTIMENTS



RÉF. ART.	DESCRIPTION
OU005732	L.530MM L.210MM

CAISSE À OUTILS TEXTILE



RÉF. ART.	DESCRIPTION
OU103540	30L 350 X 230 X 500
OU103539	550 X 270 X 300

CAISSE A OUTIL 605

SAM OUTILLAGE



RÉF. ART.
OU000447

SACOCHE PM AVEC BANDOULIERE



RÉF. ART.
OU103640

photos non contractuelles

PINCE COUPANTE

SAM OUTILLAGE



RÉF. ART.	DESCRIPTION
OU003524	BI-MATIÈRE DIAGONALE 232-16G L.165MM
OU003523	DE CÔTÉ KNIPEX
OU017151	DEMULTIPLIEE A RESSORT 180MM KNIPEX

PINCE À RIVETER

SAM OUTILLAGE



RÉF. ART.
OU003520

PINCE MULTIPRISE

KNIPEX



RÉF. ART.	DESCRIPTION
OU003532	À CRÉMAILLÈRE - KNIPEX
OU003530	AUTO-AJUSTABLE - KNIPEX
OU010557	ISOLEE ALLIGATOR CHROMEE 240MM
OU003531	L.250 MM - SAM
OU103492	PLOMBIER À BRANCHES ENTREPASSÉES

PINCE UNIVERSELLE

KNIPEX



RÉF. ART.	DESCRIPTION
OU003534	
OU010553	ISOLEE 190MM
OU003535	L.165MM

PINCE CHEVILLE MOLLY



RÉF. ART.
OU003522

photos non contractuelles

PINCE A BECS COUDES ISOLEE

KNIPEX



we
life

RÉF. ART.	DESCRIPTION
OU010554	165MM

TENAILLE RUSSE

KNIPEX



RÉF. ART.	DESCRIPTION
OU004235	À FORTE DÉMULTIPLICATION - KNIPEX
OU004236	L.22CM - KNIPEX
OU004237	L.25CM - KNIPEX
OU004238	L.28CM - KNIPEX

PINCE A BECS COUDES ISOLEE CEI

CATU



RÉF. ART.	DESCRIPTION	REFERENCE FABRICANT
OU007924	160mm	MO66402
OU007925	250mm	MO66502

PINCE A DENUDER ISOLE

SAM OUTILLAGE

RÉF. ART.	DESCRIPTION
OU020706	1000V 160MM

photos non contractuelles

JEU DE 6 TOURNEVIS SUPER RESISTANTS

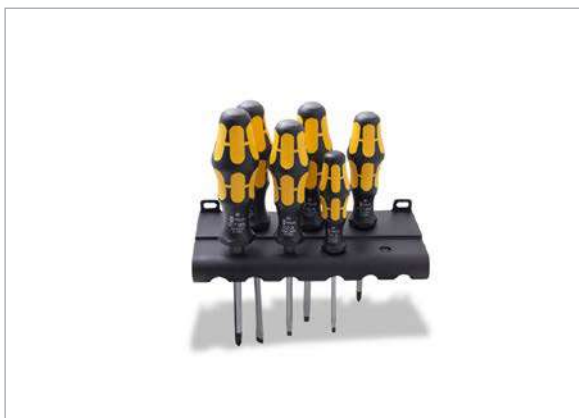

RÉF. ART.	DESCRIPTION
OU002464	(4 PLATS, 2 CRUCIFORMES)

TOURNEVIS PLAT ISOLE 1000V



RÉF. ART.	DESCRIPTION
OU004508	TOURNEVIS PLAT 2,5 x 80 ISOLE 1000V WERA
OU004509	TOURNEVIS PLAT 3,0 x 100 ISOLE 1000V WERA
OU004512	TOURNEVIS PLAT 4,0 x 100 ISOLE WERA

TOURNEVIS CRUCIFORME

SAM OUTILLAGE



RÉF. ART.	DESCRIPTION
OU004504	GROS ref:tt-3p150 - SAM
OU004505	MOYEN ref:tt-2p125 ph2x125 - SAM
OU004506	PETIT ref: 273m1 ph1x75 - SAM

TOURNEVIS PLAT ISOLE

KNIPEX



RÉF. ART.	DESCRIPTION
OU010548	3,5X200 - KNIPEX
OU010549	5,5X230 - KNIPEX
OU010550	8,0X295 - KNIPEX

photos non contractuelles

TOURNEVIS PLAT L.100MM

SAM OUTILLAGE



RÉF. ART.	DESCRIPTION
OU004511	L.4MM - SAM
OU004513	L.5,5MM - SAM

TOURNEVIS PLAT

SAM OUTILLAGE



RÉF. ART.	DESCRIPTION
OU004510	L.75MM L.3,5MM - SAM

TOURNEVIS POZIDRIV ISOLE

KNIPEX



we
life

RÉF. ART.	DESCRIPTION
OU010551	PZ1 185MM - KNIPEX
OU010552	PZ2 215MM - KNIPEX

photos non contractuelles

ETAU



RÉF. ART.	DESCRIPTION
OU002195	L.125MM

SERRE-JOINT À PRESSE MÉCANICIEN



RÉF. ART.	DESCRIPTION
OU004092	AVEC OUVERTURE L.200MM

PINCE ÉTAU

SAM OUTILLAGE



RÉF. ART.
OU003526

SERRE-JOINT DE MAÇON

SODIMAT



RÉF. ART.	DESCRIPTION	LONGUEUR	LARGEUR
OU004093	, SECTION 0,8 X 1M	L 100 CM	I 80 CM
OU004094	, SECTION 1 X 1,2M	L 120 CM	I 100 CM
OU007818	, SECTION 1,2 X 1,4M	L 140 CM	I 120 CM

SERRE-JOINT À POMPE OUVERTURE



RÉF. ART.	DESCRIPTION
OU004095	DE 500MM

photos non contractuelles

BROSSE MÉTALLIQUE

SOFOP TALIAPLAST



RÉF. ART.	DESCRIPTION
OU000327	
OU000326	VIOLON

LIME PLÂTE MI-DOUCE EMMANCHÉE

SAM OUTILLAGE



RÉF. ART.	DESCRIPTION
OU002706	250MM

LIME 1/2 RONDE

SAM OUTILLAGE



RÉF. ART.	DESCRIPTION
OU002704	1/2 DOUCE EMMANCHÉE 250MM

LIME RONDE MI-DOUCE EMMANCHÉE

SAM OUTILLAGE



RÉF. ART.	DESCRIPTION
OU002707	250MM

LIME PLÂTE EMMANCHÉE

SAM OUTILLAGE



RÉF. ART.	DESCRIPTION
OU002705	LIME PLÂTE BÂTARDE EMMANCHÉE 25BE

LIME RONDE

SAM OUTILLAGE



RÉF. ART.	DESCRIPTION
OU002708	QUEUE DE RAT

photos non contractuelles

LIMES SAM EMMANCHÉE

SAM OUTILLAGE



RÉF. ART.	DESCRIPTION
OU002463	LIMES SAM EMMANCHÉES - JEU DE 6

RAPE À BOIS

SAM OUTILLAGE



RÉF. ART.	DESCRIPTION
OU003866	1/2 RONDE BATARDE EMMANCHÉE L.250MM
OU003867	PLATE BATARDE EMMANCHÉE L.250MM
OU003868	RONDE BATARDE EMMANCHÉE L.250MM

photos non contractuelles

MARTEAU À PIQUER

SAFFRO



RÉF. ART.	DESCRIPTION
OU002844	MANCHE BOIS

MARTEAU DE COFFREUR NANOVIB

LEBORGNE



RÉF. ART.	DESCRIPTION
OU002846	

MARTEAU DE BOISEUR COFFREUR MULLER



RÉF. ART.	DESCRIPTION
OU005504	MARTEAU DE BOISEUR COFFREUR 700 GR. MANCHE FIBRE 37CM

MARTEAU MENUISIER

SAM OUTILLAGE



RÉF. ART.	DESCRIPTION
OU002848	315G 26 EF

MARTEAU DE BOISEUR COFFREUR LEBORGNE

LEBORGNE



RÉF. ART.	DESCRIPTION
OU002845	MARTEAU DE BOISEUR COFFREUR MANCHE NOVAGRIP

MARTEAU FUBAR

STANLEY



RÉF. ART.	DESCRIPTION
OU018200	MARTEAU MULTIFONCTION CHANTIERS BOIS FUBAR

photos non contractuelles

MARTEAU RIVOIR

SAM OUTILLAGE



RÉF. ART.	DESCRIPTION
OU002849	26 0,8KG
OU010516	45 MANCHE FIBRE

MASSETTE 1,25KG

LEBORGNE



RÉF. ART.	DESCRIPTION
OU002853	AVEC MANCHE - NOVAGRIP

MARTEAUX ÉLECTRICIEN SAMSOPUS®

SAM OUTILLAGE



RÉF. ART.	DESCRIPTION
OU103494	MANCHE TRIMATIÈRE 18MM

MASSETTE EMMANCHÉE

GOUVY



RÉF. ART.	DESCRIPTION
OU002854	1,2KG

MAILLET EN CAOUTCHOUC

SOFOP TALIAPLAST



RÉF. ART.	DESCRIPTION	DIAMETRE
OU007345		D 55 MM
OU005696		D 65 MM
OU002743	AVEC MANCHE 80CM	D 90 MM

TÊTE DE MARTEAU DE COFFREUR

GOUVY



Prévoir manche

RÉF. ART.
OU005505

photos non contractuelles

TÊTE DE MASSE À COUPLE

GOUVY



Prévoir manche

RÉF. ART.	DESCRIPTION
OU004258	4KG

TÊTE DE MASSETTE

GOUVY



Prévoir manche

RÉF. ART.	DESCRIPTION
OU005506	SANS MANCHE 1,2KG

MANCHE DE MARTEAU FIBRE DE VERRE

GOUVY



RÉF. ART.
OU002766

MANCHE DE MASSE

GOUVY



RÉF. ART.	DESCRIPTION
OU002767	BOIS
OU002768	FIBRE DE VERRE

MANCHE DE MASSETTE

GOUVY



RÉF. ART.	DESCRIPTION
OU002769	BOIS
OU005809	FIBRE

photos non contractuelles

CHASSE-GOUPILLE

SAM OUTILLAGE



RÉF. ART.	DIAMETRE
OU000541	D 7 MM
OU000542	D 8 MM
OU000543	D 9 MM
OU000540	D 10 MM

CHASSE-GOUPILLES

SAM OUTILLAGE

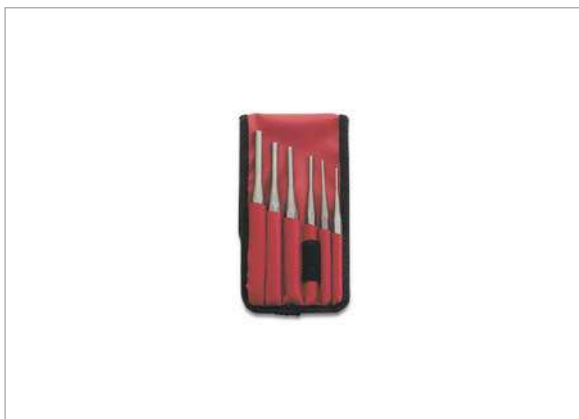

RÉF. ART.	DESCRIPTION
OU002462	D.2MM À 7MM EN TROUSSE

PORTE-MARTEAU ERGONOMIQUE LEBORGNE

LEBORGNE



S'accroche sur une ceinture, permet de porter le marteau à 45° pour éviter ainsi la gêne lorsque l'utilisateur s'accroupit. Poids : 170g. Universel : s'adapte à tout type de marteau

RÉF. ART.
OU003700

SACOCHE À CLOUS

CUIR



RÉF. ART.	DESCRIPTION
OU004051	MONOPOCHE EN CUIR
OU004050	BIPOCHE EN CUIR

photos non contractuelles

CEINTURE CONFORT AVEC PORTE MANTEAU

LEBORGNE



RÉF. ART.	DESCRIPTION	LONGUEUR
OU005697	CEINTURE CONFORT AVEC PORTE MARTEAU LEBORGNE	L 120 CM

Une idée de nouveau produit ?



RÉF. ART.	DESCRIPTION
NOUVEAU PRODUIT	mailto:t.bobin@bouygues-construction.com

CEINTURE EN CUIR AVEC PORTE MARTEAU



RÉF. ART.	LONGUEUR
OU000500	L 120 CM

CEINTURE POLYVALENTE NYLON AVEC PORTE MARTEAU



RÉF. ART.
OU000502

photos non contractuelles

FIL À PLOMB



RÉF. ART.	DESCRIPTION
OU002244	AIMANTÉ
OU002245	D'ARCHITECTE D.50MM

CORDEAU COTTON P.0,1KG



RÉF. ART.	DESCRIPTION	DIAMETRE
OU001477	CORDEAU COTTON P.0,1KG	D 2 MM

FIL À PLOMB DE MAÇON

MILBOX



RÉF. ART.	DESCRIPTION
OU005846	0,8KG
OU002246	1KG

CORDEAU NYLON P.0,1KG



RÉF. ART.	DESCRIPTION	DIAMETRE
OU001478	CORDEAU NYLON P.0,1KG	D 2 MM
OU001479	CORDEAU NYLON P.1KG	D 2 MM

CORDEAU COTTON P.0,1KG



RÉF. ART.	DIAMETRE
OU001476	D 1 MM

CORDEAU NYLON POUR FIL À PLOMB



RÉF. ART.
OU005678

photos non contractuelles

CORDEAU PP FLUO ROSE



RÉF. ART.	DESCRIPTION	COULEUR	DIAMETRE
OU001480	D.1,5MM BOBINE 500ML	ROSE	D 1,5 MM

CORDEX



RÉF. ART.	DESCRIPTION
OU007057	ALUMINIUM L.30ML
OU010901	SPEEDLINE PRO 30ML

RÈGLE ALUMINIUM 1 VOILE AVEC EMBOUTS

SOFOP TALIAPLAST



RÉF. ART.	DESCRIPTION	LONGUEUR
OU003885	L.2ML	L 200 CM
OU003887	L.3ML	L 300 CM
OU003888	L.4ML	L 400 CM

RÈGLE ALUMINIUM 2 VOILES AVEC EMBOUTS

SOFOP TALIAPLAST



RÉF. ART.	DESCRIPTION	LONGUEUR
OU003889	L.5ML	L 500 CM
OU003890	L.6ML	L 600 CM

photos non contractuelles

PIED À COULISSE



RÉF. ART.	DESCRIPTION	LARGEUR
OU003491	CAPACITÉ 250MM	I 250 MM

NIVEAU RECTANGULAIRE

MULLER



RÉF. ART.	DESCRIPTION	LONGUEUR
OU003272	L. 60cm	
OU003270	L.1,80M	L 180 CM

NIVEAU DOUBLE SEMELLE 3 FIOLES

SOFOP TALIAPLAST



RÉF. ART.	DESCRIPTION	LONGUEUR
OU003266	L.200CM	L 200 CM

NIVEAU RÈGLE ALUMINIUM

METRICA



RÉF. ART.	DESCRIPTION	LONGUEUR
OU003274	L.200CM	L 200 CM
OU003275	L.250CM	L 250 CM

NIVEAU RECTANGULAIRE EN FONTE D'ALUMINIUM

MULLER



RÉF. ART.	DESCRIPTION	LONGUEUR
OU010633	L.100CM	L 100 CM
OU010630	L.40CM	L 40 CM
OU010631	L.60CM	L 60 CM
OU010632	L.80CM	L 80 CM

photos non contractuelles

NIVEAU TRAPÈZE

MULLER



RÉF. ART.	DESCRIPTION	LONGUEUR
OU003281	L.100CM	L 100 CM
OU003279	L.60CM	L 60 CM
OU003280	L.80CM	L 80 CM

NIVEAU OPTIQUE BOSCH

 **BOSCH**



RÉF. ART.	DESCRIPTION
OU020650	GOL 26 G
OU020651	GOL 32 G

NIVEAU ELECTRONIQUE BOSCH

 **BOSCH**



RÉF. ART.	DESCRIPTION
OU020640	GIM 120
OU020639	GIM 60 L

DOUBLE MÈTRE PLIANT

METRICA



RÉF. ART.	DESCRIPTION
OU001881	EN ALUMINIUM
OU001882	EN BOIS
OU001883	EN FIBRE

photos non contractuelles

MÈTRE RUBAN BOITIER OUVERT

STANLEY



RÉF. ART.	DESCRIPTION
OU003226	L.20ML L.12,7MM

RECHARGE MÈTRE RUBAN MABOLON



RÉF. ART.	DESCRIPTION
CO005357	L.50M (jusqu'à épuisement)

MÈTRE RUBAN BOITIER RENFORCE

TAJIMA



RÉF. ART.	DESCRIPTION	LONGUEUR	LARGEUR
OU003223		L 300 CM	l 16 MM
OU003224	MÈTRE RUBAN BOITIER RENFORCE	L 500 CM	l 25 MM
OU003225		L 800 CM	l 25 MM

MÈTRE RUBAN POWERLOCK

STANLEY



RÉF. ART.	DESCRIPTION
OU003231	L.3ML STANLEY
OU003232	L.5ML STANLEY
OU003233	L.8ML STANLEY
OU003230	L.10ML STANLEY

MÈTRE RUBAN POIGNÉE ACIER

STANLEY



RÉF. ART.	DESCRIPTION
OU003227	L.30M MASTER STANLEY
OU003229	L.50M MABOLON STANLEY

MIROIR D'INSPECTION

MOINEAU



RÉF. ART.
OU103491

photos non contractuelles

ODOMETRE CLASSIQUE MECANIQUE ROUE

MOINEAU



55CM PLIÉ - 102CM DEPLIÉ

RÉF. ART.	DESCRIPTION
OU020438	Ø32 - PRECISION 1%

LUXMETRE PROFESSIONNEL

MOINEAU



RÉF. ART.

OU103490

ANÉMOMÈTRE

SKYWATCH



we
life

RÉF. ART.	DESCRIPTION
OU010909	A MAIN

ANEMOMETRE

MOINEAU



RÉF. ART.	DESCRIPTION
OU103496	DIGITAL MULTIDIRECTIONNEL

photos non contractuelles

THERMOMETRE DE POCHE -50/+260°C

MOINEAU



RÉF. ART.

DESCRIPTION

OU008046

REF TX880 TEC

THERMOMETRE INFRAROUGE A VISEE LASER -

SARL MOINEAU



RÉF. ART.

DESCRIPTION

OU103530

COMPACT -50°C/+500°C

THERMOMETRE MINI MAXI

MOINEAU



AJ1801 THERMOMETRE PLASTIQUE

RÉF. ART.
OU004260

THERMOMETRE TYPE K - 2 CANAUX

MOINEAU



- MÉMOIRE MAXI

RÉF. ART.	DESCRIPTION
OU103495	- 2 SONDAS FILAIRES TYPES K

BALANCE INDUSTRIELLE

MOINEAU



RÉF. ART.	DESCRIPTION
OU103458	- PORTEE 120 KG ET LECTURE A 10G

CODEX DE TRAÇAGE À REMBOBINAGE RAPIDE GÉANT



RÉF. ART.	DESCRIPTION
OU001481	30ML

photos non contractuelles

COMPAS D'ÉPAISSEUR À RESSORTS ACIER

WILMART



RÉF. ART.	DESCRIPTION
OU103429	250 MM

CONTROLEUR D'ÉPAISSEUR MAGNETIQUE - ENREGISTREUR

MOINEAU



RÉF. ART.	DESCRIPTION
OU103457	

CHABLOT SISAL



RÉF. ART.	DESCRIPTION
IN000503	D.12MM L.4ML

REFRACTOMETRE ETHYLENE, PORPYLENE, ...

MOINEAU



AUTRE LASER ROTATIF HILTI
ETHYLENE, PORPYLENE, LAVE-GLACE (GLYCOL) ET LIQUIDE
DE BATTERIE

RÉF. ART.	REFERENCE FABRICANT
OU103456	429420

CELLULE DE GUIDAGE PRM

HILTI



Capteur pour machines d'excavations

RÉF. ART.	DESCRIPTION	REFERENCE FABRICANT
OU016871	15	2190588

photos non contractuelles

Ferroskan PS 300



RÉF. ART.	DESCRIPTION	REFERENCE FABRICANT
OU105447	- W kit - UNITE	3687035

Lasermètre PD-I



RÉF. ART.	DESCRIPTION	REFERENCE FABRICANT
OU105518	- UNITE	2190182

LASERMÈTRE DISTO

METRICA



MESURE LASER 200 M MAX

RÉF. ART.	DESCRIPTION	LONGUEUR
OU005198	D510	L 200 M

LASERMETRE PD-S



RÉF. ART.	REFERENCE FABRICANT
OU020784	2152385

photos non contractuelles

LASERMETRE PD-E 200M



Laser extrêmement robuste pour les applications extérieures et de longues distances jusqu'à 200 m - Précision: ± 1 mm - Classe laser: < 1 mW, 635 nm, Classe 2 (IEC 60825-1:2007), Classe II (FDA CFR 21 art. 1040) - Distance de mesure max.: 200 m - Addition Soustraction, Surface, Volume, Zone de peinture, Disposition, min./max., Minuterie, Désaxage, Mémoire (30 x), Trapézoïdal (2 x), Pythagore (3 x), Mesure indirecte (4 x) - Mesure unique et en continu, Mode extérieur, Niveau d'eau nu

RÉF. ART.	DESCRIPTION	REFERENCE FABRICANT
OU008610	MAX PRECISION 1MM	2212517

TELEMETRE LASER BOSCH GLM



RÉF. ART.	DESCRIPTION	REFERENCE FABRICANT
OU020635	40	
OU020634	50 C	
OU020636	80	
OU020637	120 C	
OU105982	LASERMETRE BOSCH 250 METRES GLM250VF	601072100

TÉLÉMÈTRE LASER DISTANCE MAXI

MAKITA



DISTANCE MAXI 50ML CLASSE IP54

RÉF. ART.	DESCRIPTION	LONGUEUR
OU010494	50ML	L 50 M
OU010495	80ML	L 80 M

LASER COMBINE PMC 46 KIT



Laser combiné deux lignes, cinq points pour toutes les applications intérieures - Précision: ± 2 mm à 10 m - Classe laser: < 1 mW, 635 nm, Classe 2 (IEC 60825-1:2008), Classe II (FDA CFR 21 art. 1040) - Plage d'auto-alignement à température ambiante: ± 5 ° - Niveau horizontal, Alignement vertical, Aplomb, Équerrage - Equipé batteries chargeur, trépied, coffret, sacoche

RÉF. ART.	REFERENCE FABRICANT
OU005188	411207

photos non contractuelles

LASER COMBINE PMC 46 SEUL



Laser combiné deux lignes, cinq points pour toutes les applications intérieures - Précision: ± 2 mm à 10 m - Classe laser: < 1 mW, 635 nm, Classe 2 (IEC 60825-1:2008), Classe II (FDA CFR 21 art. 1040) - Plage d'auto-alignement à température ambiante: $\pm 5^\circ$ - Niveau horizontal, Alignement vertical, Aplomb, Équerrage - Equipé batteries chargeur, trépied, coffret, sacoche

RÉF. ART.	REFERENCE FABRICANT
OU009049	2149922

LASER DE CANALISATION PP 10



Précision: ± 0.5 mm à 10 m - Système d'alignement: Mise à niveau automatique ($\pm 10\%$) - Plage des réglages de l'inclinaison suivant l'axe X: -15-40% - Faisceau laser à point unique, Inclinaison numérique, Alignement vertical - Alignement automatique - Equipé batteries, chargeur, télécommande, vis calante, coffret

RÉF. ART.	REFERENCE FABRICANT
OU017384	2047044

LASER LIGNES PM 2-L



RÉF. ART.	REFERENCE FABRICANT
OU005190	2065572

LASER MULTILIGNES PM 4-M KIT TREPIED PMA20 +CAPTEUR PMA31



Laser tout-en-un multiligne avec trois lignes verticales et une ligne horizontale, pour toutes les applications intérieures

RÉF. ART.	REFERENCE FABRICANT
OU010614	411279

photos non contractuelles

LASER POINT PMP 45



Laser compact cinq points pour les applications fil à plomb et équerrage - Précision: ± 2 mm à 10 m - Classe laser: < 1 mW, 635 nm, Classe 2 (IEC 60825-1:2008), Classe II (FDA CFR 21 art. 1040) - Plage d'auto-alignement à température ambiante: ± 5 ° - Aplomb, Équerrage, Niveau horizontal, Alignement vertical - Equipé batteries, sacoche

RÉF. ART.	DESCRIPTION	REFERENCE FABRICANT
OU005191	ATTENTION PAS DE LIGNES	2097583

LASER ROTATIF PR 300-HV2S



Laser rotatif double pente robuste pour applications horizontales, verticales et en double pente en extérieur telles que la réalisation de plans inclinés sur deux axes - Précision: ± 0.5 mm à 10 m - Classe laser: Classe 2 (IEC 60825-1:2007) - Plage de fonctionnement avec récepteur laser (diamètre): 2-600 m - Nivellement horizontal, Alignement vertical, Double inclinaison numérique, Un faisceau laser à 90° - Entièrement automatique - Equipé batteries, chargeur, télécommande, support capteur, co

RÉF. ART.	REFERENCE FABRICANT
OU016946	3556560

LASER ROTATIF PR 30-HVS



Laser rotatif double pente robuste pour applications horizontales, verticales et en double pente en extérieur telles que la réalisation de plans inclinés sur deux axes - Précision: ± 0.5 mm à 10 m - Classe laser: Classe 2 (IEC 60825-1:2007) - Plage de fonctionnement avec récepteur laser (diamètre): 2-600 m - Nivellement horizontal, Alignement vertical, Double inclinaison numérique, Un faisceau laser à 90° - Entièrement automatique - Equipé batteries, chargeur, télécommande, support capteur, co

RÉF. ART.	DESCRIPTION	REFERENCE FABRICANT
OU017223	A12 B12/2.6 + C4/12-50	3556854
OU009377	A-12 PACK FACADIER	2181022

LASER ROTATIF PR 30-HVSG



Laser rotatif double pente robuste pour applications horizontales, verticales et en double pente en extérieur telles que la réalisation de plans inclinés sur deux axes - Précision: ± 0.5 mm à 10 m - Classe laser: Classe 2 (IEC 60825-1:2007) - Plage de fonctionnement avec récepteur laser (diamètre): 2-600 m - Nivellement horizontal, Alignement vertical, Double inclinaison numérique, Un faisceau laser à 90° - Entièrement automatique - Equipé batteries, chargeur, télécommande, support capteur, co

RÉF. ART.	DESCRIPTION	REFERENCE FABRICANT
OU019881	A12	2149765

photos non contractuelles

LASERS MULTILIGNES PM 40-MG



Laser tout-en-un multiligne avec trois lignes verticales et une ligne horizontale, pour toutes les applications intérieures - Précision: ± 2 mm à 10 m - Classe laser: < 1 mW, 635 nm, Classe 2 (IEC 60825-1:2008), Classe II (FDA CFR 21 art. 1040) - Plage d'auto-alignement à température ambiante: $\pm 3^\circ$ - Équerrage, Niveau horizontal, Alignement vertical, Aplomb - Equipé batteries, adaptateur trépied, coffret

RÉF. ART.	REFERENCE FABRICANT
OU017985	2047072

LASERS MULTILIGNES PM 4-M -



AUTRE LASER ROTATIF HILTI

Laser tout-en-un multiligne avec trois lignes verticales et une ligne horizontale, pour toutes les applications intérieures - Précision: ± 2 mm à 10 m - Classe laser: < 1 mW, 635 nm, Classe 2 (IEC 60825-1:2008), Classe II (FDA CFR 21 art. 1040) - Plage d'auto-alignement à température ambiante: $\pm 3^\circ$ - Équerrage, Niveau horizontal, Alignement vertical, Aplomb - Equipé batteries, adaptateur trépied, coffret

RÉF. ART.	DESCRIPTION	REFERENCE FABRICANT
OU016950	LASERS MULTILIGNES PM 4-M	428300

LASER COMBINES ET/OU LIGNES ET/OU ROTATIF



RÉF. ART.	TAILLE
OU020644	Laser rouge
OU020646	Laser rouge
OU020648	Laser rouge
OU020649	Laser vert
OU020645	Laser vert
OU020647	Laser vert

KIT PM40-MG BATTERIE + CHARGEUR



RÉF. ART.	DESCRIPTION	REFERENCE FABRICANT
OU100979	(VENDU A L'UNITÉ)	3527127

photos non contractuelles

KIT POL 15 + PUA 15 + PUA 54 CME-T



Niveau optique pour les tâches de nivellement quotidiennes avec optique lumineuse de haute qualité pour une lecture précise des mires graduées et grossissement 28 fois

RÉF. ART.	REFERENCE FABRICANT
OU016933	2008654

KIT PR 2-HS A12 + B12/2.6 + C4/12-50



Laser rotatif robuste disposant d'une protection antichoc à 360° et d'une batterie Li-Ion à charge rapide, pour les applications horizontales et de pentes manuelles en extérieur

RÉF. ART.	REFERENCE FABRICANT
OU017375	3556557

Kit POT 10 + PUA 35



Théodolite avec optique de haute qualité et grossissement 30 fois pour le nivellement et l'alignement de composants structurels, la réalisation de pentes et d'angles

RÉF. ART.	REFERENCE FABRICANT
OU009081	3556556

KIT PR 2-HS A12 + TRÉPIED ET MIRE -



Laser rotatif robuste disposant d'une protection antichoc à 360° et d'une batterie Li-Ion à charge rapide, pour les applications horizontales et de pentes manuelles en extérieur

RÉF. ART.	DESCRIPTION	REFERENCE FABRICANT
OU017376	KIT PR 2-HS A12 + TRÉPIED ET MIRE	3556562

photos non contractuelles

MIRE ALU GRADUEE A4 PUA

HILTI

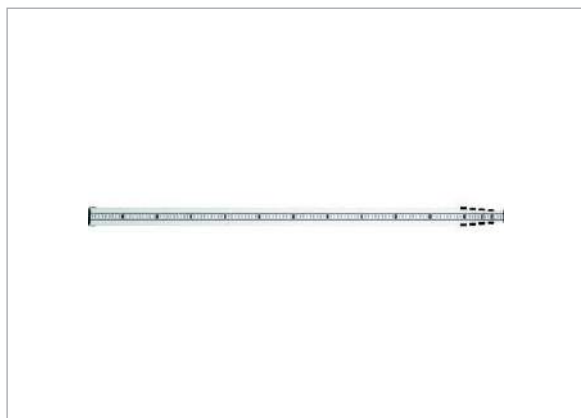

STATION HILTI POS 15_STATION HILTI POS 18

RÉF. ART.	DESCRIPTION	REFERENCE FABRICANT
OU005235	50	2103185

KIT PR 30 -HVS A 12 + TRÉPIED MOTORISÉ

HILTI



RÉF. ART.	REFERENCE FABRICANT
OU018539	3556858

KIT PR 300-HV2S PACK TERRASSEMENT

HILTI



Laser rotatif double pente robuste pour applications horizontales, verticales et en double pente en extérieur telles que la réalisation de plans inclinés sur deux axes

RÉF. ART.	REFERENCE FABRICANT
OU017378	3556855

KIT PR 300-HV2S + TRÉPIED ET MIRE

HILTI



Laser rotatif double pente robuste pour applications horizontales, verticales et en double pente en extérieur telles que la réalisation de plans inclinés sur deux axes

RÉF. ART.	REFERENCE FABRICANT
OU017379	3556856

photos non contractuelles

KIT PR 300-HV2S + TRÉPIED MOTORISÉ

HILTI



Laser rotatif double pente robuste pour applications horizontales, verticales et en double pente en extérieur telles que la réalisation de plans inclinés sur deux axes

RÉF. ART.	REFERENCE FABRICANT
OU017380	3556561

KIT PR 30-HVS A12 + TRÉPIED ET MIRE -

HILTI



Laser rotatif double pente robuste pour applications horizontales, verticales et en double pente en extérieur telles que la réalisation de plans inclinés sur deux axes

RÉF. ART.	DESCRIPTION	REFERENCE FABRICANT
OU017381	KIT PR 30-HVS A12 + TRÉPIED ET MIRE	3569280

MIRE ALU GRADUEE A4 PUA

HILTI

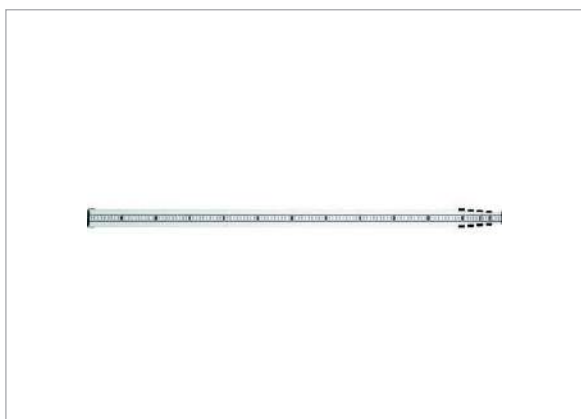

STATION HILTI POS 15_STATION HILTI POS 18

RÉF. ART.	DESCRIPTION	REFERENCE FABRICANT
OU005235	50	2103185

KIT PS 1000

HILTI



RÉF. ART.	DESCRIPTION	REFERENCE FABRICANT
OU018232	(VENDU A L'UNITÉ)	3563955

photos non contractuelles

KIT PS 1000+TROLLEY + LOGICIEL BUREAU

HILTI



RÉF. ART.	DESCRIPTION	REFERENCE FABRICANT
OU018084	(3) (VENDU A L'UNITÉ)	3631543

KIT PS 300 + C4/12 + B12 + Logiciel PC

HILTI



RÉF. ART.	REFERENCE FABRICANT
OU100481	411210

LUNETTE POL 10

HILTI



RÉF. ART.	DESCRIPTION	REFERENCE FABRICANT
OU002728		3527128
OU010033	KIT PUA 15 + PUA 54 CME-T	428301

LUNETTE POL 15

HILTI



AUTRE LASER ROTATIF HILTI

RÉF. ART.	REFERENCE FABRICANT
OU002729	2075559

photos non contractuelles

MULTIDECTEUR PS 50



RÉF. ART.	REFERENCE FABRICANT
OU009443	435295

TRANSPONTEUR PX10



AUTRE LASER ROTATIF HILTI

RÉF. ART.	DESCRIPTION	REFERENCE FABRICANT
OU004516	-273124	273126
OU004517	KIT	2154110

THEODOLITE POT 10



AUTRE LASER ROTATIF HILTI

Théodolite avec optique de haute qualité et grossissement 30 fois pour le nivellement et l'alignement de composants structurels, la réalisation de pentes et d'angles - Précision de mesure d'angle (DIN 18723): 5 arcsec - Grossissement: 30 x - Type de compensateur: 1 axe, Liquide - Equipé batteries, clé d'ajustage, adaptateurs secteur, coffret

RÉF. ART.	REFERENCE FABRICANT
OU017007	273124

X-SCAN PS 1000 + TROLLEY



RÉF. ART.
OU020604

photos non contractuelles

DETECTEUR DE METAUX

BOSCH



RÉF. ART.
OU020641

DETECTEUR/CAMERA THERMIQUE

BOSCH



RÉF. ART.	DESCRIPTION
OU020642	GIS 1000 C
OU020643	GTC 400 C

MESUREUR D'ANGLE BOSCH GAM 270 MFL

BOSCH



RÉF. ART.
OU020638

SUR COMMANDE = soumis à des délais supérieurs à ceux habituels

SUR COMMANDE = SOUMIS À DES DÉLAIS SUPÉRIEURS À CEUX HABITUELS



RÉF. ART.
SUR COMMANDE

photos non contractuelles

MIRE BOSCH GR 240

 **BOSCH**



RÉF. ART.
OU020654

TREPIED DE CHANTIER BOSCH

 **BOSCH**



RÉF. ART.	DESCRIPTION	REFERENCE FABRICANT
OU020653	BT 150	
OU020652	BT 160	435297

ADAPTATEUR SECTEUR

 **HILTI**



 **SUR COMMANDE**

AUTRE LASER ROTATIF HILTI

RÉF. ART.	DESCRIPTION	REFERENCE FABRICANT
OU009126	POA 81	428677
OU009135	PPA 89	2006089
OU009117	PUA 81	2183225

ADAPTATEUR SR

 **HILTI**



 **SUR COMMANDE**

AUTRE LASER ROTATIF HILTI

RÉF. ART.	DESCRIPTION	REFERENCE FABRICANT
OU018652	CA	411286

ADAPTATEUR UNIVERSEL

HILTI



AUTRE LASER ROTATIF HILTI

RÉF. ART.	DESCRIPTION	REFERENCE FABRICANT
OU000049	PMA 78	2103089

BARREAU POAW-

HILTI

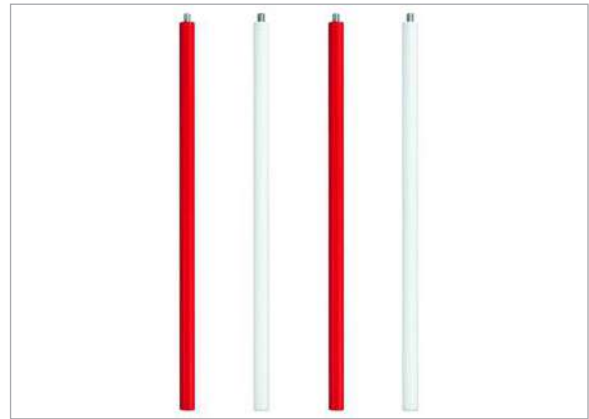

AUTRE LASER ROTATIF HILTI

RÉF. ART.	DESCRIPTION	REFERENCE FABRICANT
OU010031	1	2103087

ANTENNE POW

HILTI



AUTRE LASER ROTATIF HILTI

RÉF. ART.	DESCRIPTION	REFERENCE FABRICANT
OU016845	93	435288

BATTERIE POA

HILTI



RÉF. ART.	DESCRIPTION	REFERENCE FABRICANT
OU016848	90 JEU	2115932
OU017420	93	2131204
OU017421	99	2149915

photos non contractuelles

BATTERIE PSA

HILTI



AUTRE LASER ROTATIF HILTI

RÉF. ART.	DESCRIPTION	REFERENCE FABRICANT
OU017422	83	2077857

BLOC ACCU POA

HILTI



AUTRE LASER ROTATIF HILTI

RÉF. ART.	DESCRIPTION	REFERENCE FABRICANT
OU010669	80	233798
OU004864	BLOC ACCU PPA 82 NIMH	282834

BIPIED POA

HILTI



AUTRE STATION HILTI_STATION HILTI POS 15_STATION HILTI POS 18

RÉF. ART.	DESCRIPTION	REFERENCE FABRICANT
OU016849	75	435296

BLOC ACCU PRA

HILTI



LASER ROTATIF HILTI PR 2_LASER ROTATIF HILTI PR 30_AUTRE LASER ROTATIF HILTI

RÉF. ART.	DESCRIPTION	REFERENCE FABRICANT
OU004865	801	360055
OU004867	84	2044323
OU017423	84 G	428381
OU016851	87	377472

photos non contractuelles

BLOC ACCU PSA

HILTI



AUTRE LASER ROTATIF HILTI

RÉF. ART.	DESCRIPTION	REFERENCE FABRICANT
OU004868	80	2006182
OU016852	81	2006183
OU016853	82	2118936

BOITIER DE PILES PPA

HILTI



AUTRE LASER ROTATIF HILTI
Pour appareils PP 10 et PP 11

RÉF. ART.	DESCRIPTION	REFERENCE FABRICANT
OU004877	83	233797

BLOC D'ALIMENTATION PDA

HILTI



AUTRE LASER ROTATIF HILTI

RÉF. ART.	DESCRIPTION	REFERENCE FABRICANT
OU017424	82	233799

CABLE DE CONNEXION PPA

HILTI



Pour appareils PP 10 et PP 11

RÉF. ART.	DESCRIPTION	REFERENCE FABRICANT
OU000420	84	2202193

photos non contractuelles

CÂBLE DE PUISSANCE POA

HILTI



AUTRE LASER ROTATIF HILTI

RÉF. ART.	DESCRIPTION	REFERENCE FABRICANT
OU019012	114	2126019

CANNE DE REFLECTEUR POAW

HILTI



AUTRE LASER ROTATIF HILTI

RÉF. ART.	DESCRIPTION	REFERENCE FABRICANT
OU016865	40 ADAPTATEUR	2042325
OU016866	41 ADAPTATEUR	2042326
OU016867	42 ADAPTATEUR	2103187
OU016868	44 ADAPTATEUR	2126237
OU017426	CANNE DE RÉFLECTEUR POAW 50 ADAPTATEUR	2068485

CANNE DE REFLECTEUR POA

HILTI



AUTRE LASER ROTATIF HILTI

RÉF. ART.	DESCRIPTION	REFERENCE FABRICANT
OU017425	CANNE DE RÉFLECTEUR POA 29	435287
OU016861	50	2042048
OU016862	52	2048237
OU016863	53	2042300
OU016864	54 KIT	2042324

CAPTEUR / TELECOMMANDE LASER PRA

HILTI



AUTRE LASER ROTATIF HILTI

RÉF. ART.	DESCRIPTION	REFERENCE FABRICANT
OU010001	30	411288

photos non contractuelles

CAPTEUR LASER PMA

HILTI



RÉF. ART.	DESCRIPTION	REFERENCE FABRICANT
OU000481	31	2152388
OU018702	31 G	2071120

CARTE MEMOIRE PSA

HILTI



FERROSCAN HILTI PS 250_LASER ROTATIF HILTI PR 2_LASER ROTATIF HILTI PR 30_LASER ROTATIF HILTI PR 36_AUTRE LASER ROTATIF HILTI

RÉF. ART.	DESCRIPTION	REFERENCE FABRICANT
EL009148	91	305143

CAPTEUR LASER PRA

HILTI



AUTRE LASER ROTATIF HILTI

RÉF. ART.	DESCRIPTION	REFERENCE FABRICANT
OU009464	CAPTEUR LASER PRA 20	305141

CASQUE MICROPHONE PSA

HILTI



RÉF. ART.	DESCRIPTION	REFERENCE FABRICANT
OU000499	93	3486745

CERTIFICAT DE CONFORMITE

HILTI

AUTRE LASER ROTATIF HILTI

RÉF. ART.	DESCRIPTION	REFERENCE FABRICANT
OU020465	A LA CDE TYP2.1	2006180

photos non contractuelles

CHARGEUR D'ACCU P. VOITURE PUA

HILTI



AUTRE STATION HILTI_STATION HILTI POS 15_STATION HILTI POS 18

RÉF. ART.	DESCRIPTION	REFERENCE FABRICANT
OU016878	82	435298

CHARGEUR D'ACCU PUA

HILTI



AUTRE LASER ROTATIF HILTI

RÉF. ART.	DESCRIPTION	REFERENCE FABRICANT
OU009136	83	2149916
OU017428	CHARGEUR De VOITURE PUA 86 19V	2042309

CHARGEUR D'ACCU POA

HILTI



RÉF. ART.	DESCRIPTION	REFERENCE FABRICANT
OU009127	82	2042317
OU016879	87 JEU	2115933
OU017427	92	2044710

CLIQUET SANGLE MUR POAW

HILTI

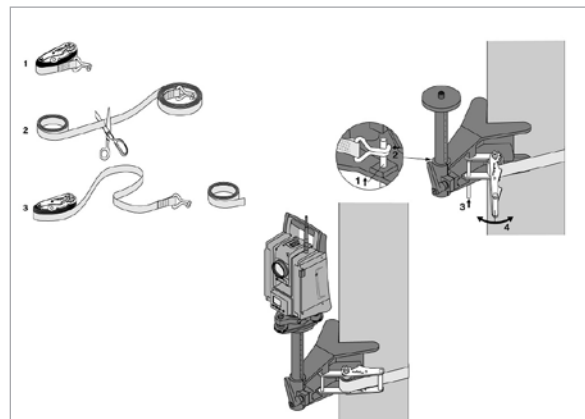

RÉF. ART.	DESCRIPTION	REFERENCE FABRICANT
OU017431	54	2088508

photos non contractuelles

COFFRET PM 4-M KIT VIDE

HILTI



RÉF. ART.	REFERENCE FABRICANT
OU016887	2283290

COFFRET PRI VIDE

HILTI



FERROSCAN HILTI PS 250

RÉF. ART.	DESCRIPTION	REFERENCE FABRICANT
OU001197	COFFRET PRI 2	2044482

Coffret PMA 62 VIDE

HILTI



LASER ROTATIF HILTI PR 2

RÉF. ART.	DESCRIPTION	REFERENCE FABRICANT
OU105428	Coffret PMA 62 - UNITE VIDE	368379

COFFRET VIDE PS250

HILTI



RÉF. ART.	REFERENCE FABRICANT
OU009114	2115936

COFFRET PRE VIDE

HILTI

LASER ROTATIF HILTI PR 2

RÉF. ART.	DESCRIPTION	REFERENCE FABRICANT
OU001196	COFFRET PRE 3 TYP 027	331422

photos non contractuelles

COLLIER RAPIDE POA

HILTI



RÉF. ART.	DESCRIPTION	REFERENCE FABRICANT
OU017432	79	2173253

ETAI TELESCOPIQUE PUA 10

HILTI

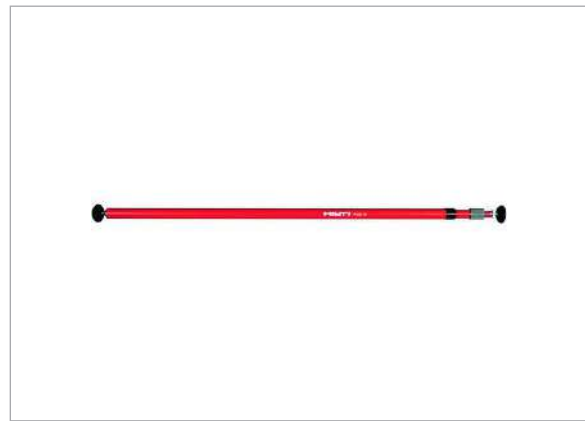

RÉF. ART.	REFERENCE FABRICANT
OU002194	2126060

DETECTION OFFICE

HILTI

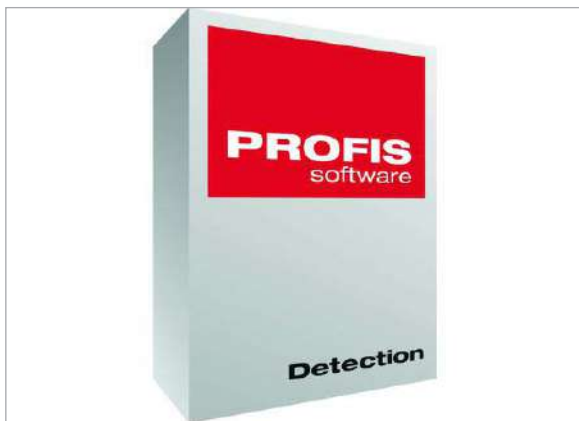

AUTRE LASER ROTATIF HILTI

RÉF. ART.	REFERENCE FABRICANT
OU018679	378038

FEUILLE DE COLLAGE POA 30

HILTI



STATION HILTI POS 15_STATION HILTI POS 18

RÉF. ART.	REFERENCE FABRICANT
OU017433	435291

FEUILLE REFLECHISSANTE POAW-

HILTI

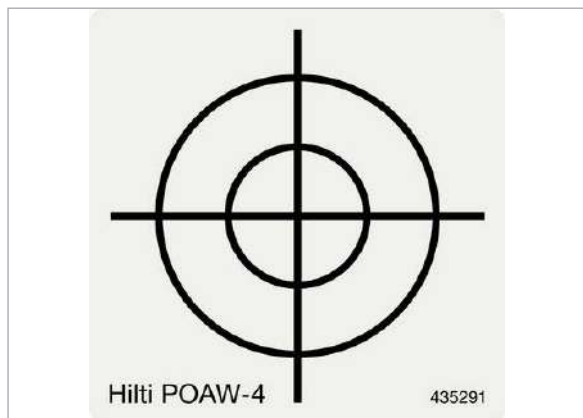

RÉF. ART.	DESCRIPTION	REFERENCE FABRICANT
OU010030	4 (JEU)	3515557

KIT KIT PRA

HILTI



RÉF. ART.	DESCRIPTION	REFERENCE FABRICANT
OU016917	90 STANDARD	3546063

KIT KIT TREPIED PUA 25 + MIRE PUA

HILTI



AUTRE STATION HILTI

RÉF. ART.	DESCRIPTION	REFERENCE FABRICANT
OU019801	53 -	273132

LANGUETTE ADHESIVE PUA

HILTI



RÉF. ART.	DESCRIPTION	REFERENCE FABRICANT
OU005187	92 LOT DE 50	2065448

photos non contractuelles

LUNETTES SPECIALES LASER PP

HILTI



AUTRE LASER ROTATIF HILTI

RÉF. ART.	DESCRIPTION	REFERENCE FABRICANT
OU009608	EY-GU R	2107220

PIED MAGNETIQUE PMA

HILTI



LASER ROTATIF HILTI PR 2_LASER ROTATIF HILTI PR 3_AUTRE LASER ROTATIF HILTI

RÉF. ART.	DESCRIPTION	REFERENCE FABRICANT
OU018694	86	285415

OCULAIRE COUDE POA

HILTI



RÉF. ART.	DESCRIPTION	REFERENCE FABRICANT
OU016962	72	2160375

PLAQUETTE CIBLE POA

HILTI



LASER ROTATIF HILTI PR 36
Pour PRI 2, PR 25, PR 26 -

RÉF. ART.	DESCRIPTION	REFERENCE FABRICANT
OU005313	PLAQUETTE CIBLE PRA 50	226976

PLAQUETTE CIBLE PRA

HILTI



Pour PRI 2, PR 25, PR 26 -

RÉF. ART.	DESCRIPTION	REFERENCE FABRICANT
OU005314	54 (CM/IN)	2115938
OU017437	PLAQUETTE-CIBLE POA 26 CARRÉ LOT DE 5 -	2071083

PLATINE INCLINABLE PRA

HILTI



AUTRE LASER ROTATIF HILTI

RÉF. ART.	DESCRIPTION	REFERENCE FABRICANT
OU016968	79	2042329

POINTEAU POAW

HILTI



AUTRE STATION HILTI

RÉF. ART.	DESCRIPTION	REFERENCE FABRICANT
EL009096	46	2042043

PRISME POA

HILTI



AUTRE LASER ROTATIF HILTI

RÉF. ART.	DESCRIPTION	REFERENCE FABRICANT
OU016973	20	2042045
EL010561	22 PETIT	2115937
OU017438	25	2062052

photos non contractuelles

PROLONGATEUR DE MESURE PDA

HILTI



AUTRE LASER ROTATIF HILTI

RÉF. ART.	DESCRIPTION	REFERENCE FABRICANT
OU016976	72	377847

SUPPORT CHAISE PRA

HILTI



LASER ROTATIF HILTI PR 2_AUTRE LASER ROTATIF HILTI

RÉF. ART.	DESCRIPTION	REFERENCE FABRICANT
OU010004	750 POUR LASER (VENDU A L'UNITÉ)	282837

SACOCHES POUR TREPIED PUA 40

HILTI



Pour appareils PR 16, PR 20, PR 25, PR 28, PMP 34, PML 32-R, PD 28 -

RÉF. ART.	REFERENCE FABRICANT
OU004054	2200273

SUPPORT DE CAPTEUR ELECTRONIQUE

HILTI



LASER ROTATIF HILTI PR 2

RÉF. ART.	DESCRIPTION	REFERENCE FABRICANT
OU004146	SUPPORT DE CAPTEUR ELECTRONIQUE PRA 75	331420
OU004147	SUPPORT DE CAPTEUR ELECTRONIQUE PRA 77	360058
OU004145	SUPPORT DE CAPTEUR ELECTRONIQUE PRA 80	2071084
OU008924	SUPPORT DE CAPTEUR ELECTRONIQUE PRA 83	2160374

SUPPORT MURAL AVEC SUPPORT MAGNETIQUE

HILTI



RÉF. ART.	DESCRIPTION	REFERENCE FABRICANT
OU018112	SUPPORT MURAL AVEC SUPPORT MAGNÉTIQUE PM	2044040

SUPPORT MURAL

HILTI



LASER ROTATIF HILTI PR 2_LASER ROTATIF HILTI PR 36

RÉF. ART.	DESCRIPTION	REFERENCE FABRICANT
OU017440	POA 74	2088509
OU009064	PRA 72	426384

TELECOMMANDE / CAPTEUR LASER PRA

HILTI



AUTRE LASER ROTATIF HILTI

RÉF. ART.	DESCRIPTION	REFERENCE FABRICANT
OU010250	35	2044077
OU017002	TELECOMMANDE / CAPTEUR LASER PRA 36	331418

TELECOMMANDE PRA

HILTI



FERROSCAN HILTI PS 250

RÉF. ART.	DESCRIPTION	REFERENCE FABRICANT
OU004234	2	377654

photos non contractuelles

TRAME DE MESURE PSA

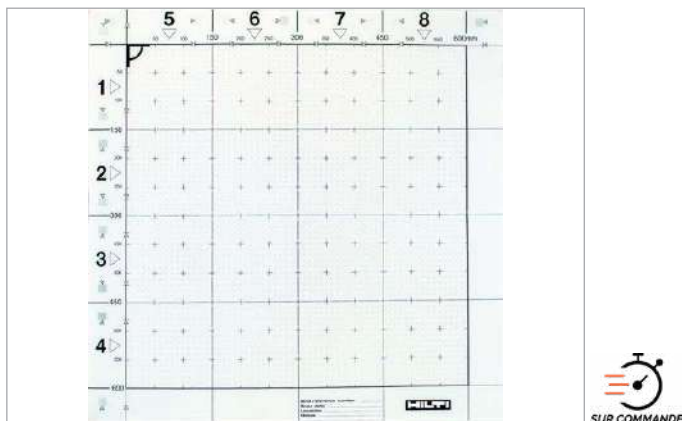

LASER ROTATIF HILTI PR 2_LASER ROTATIF HILTI PR 3_AUTRE LASER ROTATIF HILTI

RÉF. ART.	DESCRIPTION	REFERENCE FABRICANT
OU004515	10 LOT DE 5	202369

TREPIED LASER A MANIVELLE PA



LASER ROTATIF HILTI PR 2_LASER ROTATIF HILTI PR 3_LASER ROTATIF HILTI PR 30_LASER ROTATIF HILTI PR 36_AUTRE LASER ROTATIF HILTI

RÉF. ART.	DESCRIPTION	REFERENCE FABRICANT
OU105705	Tripied à manivelle PA 921 - UNITE	315998

TREPIED A MANIVELLE



RÉF. ART.	DESCRIPTION	REFERENCE FABRICANT
OU009171	PUA 30	2236894

TREPIED PMA



AUTRE LASER ROTATIF HILTI
Pour appareils PR 16, PR 20, PR 25, PR 28, PMP 34, PML 32-R, PD 28

RÉF. ART.	DESCRIPTION	REFERENCE FABRICANT
OU004520	TREPIED LASER A MANIVELLE PA931 (CM)	411287
OU004522	20	2017478

photos non contractuelles

TREPIED PRA



AUTRE LASER ROTATIF HILTI
Trépied motorisé pour une mise à hauteur automatique - pour une meilleure productivité lors de transferts de hauteurs

RÉF. ART.	DESCRIPTION	REFERENCE FABRICANT
OU017010	90	2112084

TREPIED PUA



LASER ROTATIF HILTI PR 2_LASER ROTATIF HILTI PR 30_AUTRE LASER ROTATIF HILTI

RÉF. ART.	DESCRIPTION	REFERENCE FABRICANT
OU010584	15	2107119
OU008925	25	233803

MIRE ALU GRADUEE A4 PUA

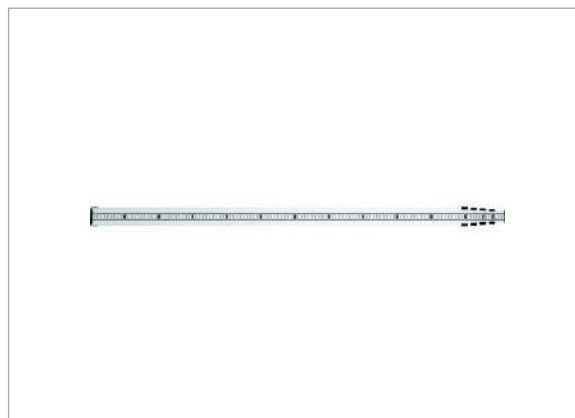

STATION HILTI POS 15_STATION HILTI POS 18

RÉF. ART.	DESCRIPTION	REFERENCE FABRICANT
OU005235	50	2103185

WISEUR TELESCOPIQUE PPA



Pour appareils PP 10 et PP 11 -

RÉF. ART.	DESCRIPTION
OU005478	40

photos non contractuelles

POMPE À GRAISSE MÉTALLIQUE

PRESSOL



RÉF. ART.

OU007107

BEC COUDÉ SERINGUE L.150MM

PRESSOL



RÉF. ART.

OU007108

BURETTE À HUILE EN MÉTAL

PRESSOL



RÉF. ART.

OU007442

BEC VERSEUR FLEXIBLE MÉTALLIQUE POUR JERRICAN

PRESSOL



RÉF. ART.

OU007232

BURETTE MÉTALLIQUE AVEC POMPE PLASTIQUE

PRESSOL



RÉF. ART.

OU007505

DESCRIPTION

250ML

COFFRET D'ACCESSOIRE POUR POMPE A GRAISSE

PRESSOL

RÉF. ART.

OU103424

photos non contractuelles

ENTONNOIR PVC AVEC BEC VERSEUR

PRESSOL

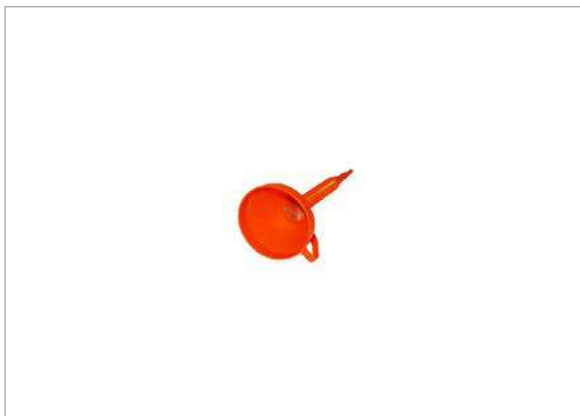

RÉF. ART.

OU006286

JERRICAN FUEL MÉTAL 20L

PRESSOL



RÉF. ART.

OU007230

JERRICAN CARBURANT EN ACIER 5L

PRESSOL



RÉF. ART.

OU007229

JERRICAN PLASTIQUE 20L + FLEXIBLE

PRESSOL



RÉF. ART.

OU007235

JERRICAN FUEL EN PLASTIQUE AVEC BEC VERSEUR 11L

PRESSOL



RÉF. ART.

OU007233

PISTOLET À PEINTURE EUROSPRAY

EUROMAIR



RÉF. ART.

OU005307

DESCRIPTION

E60 SUR BATTERIE

photos non contractuelles

PULVÉRISATEUR EN CUVE INOX

GLORIA



RÉF. ART.	DESCRIPTION
OU003755	10L
OU003756	5L

BUSE À JET PLAT POUR GLORIA

GLORIA

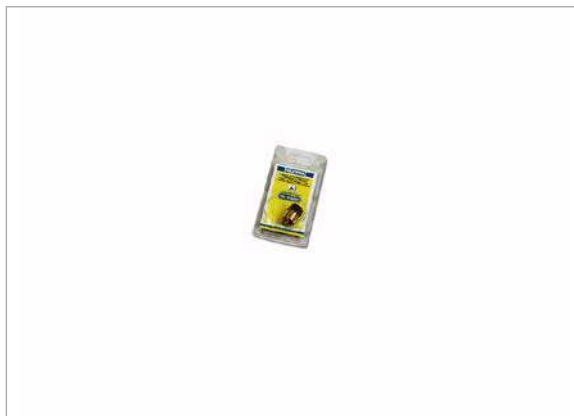

RÉF. ART.
OU000400

PULVÉRISATEUR EN CUVE PLASTIQUE

GLORIA



RÉF. ART.	DESCRIPTION
OU003754	5L

HÉLICE + BUSE DE RECHANGE POUR PULVÉRISATEUR

GLORIA



RÉF. ART.
OU002421

PULVÉRISATEUR PLASTIQUE



RÉF. ART.	DESCRIPTION
OU017103	1L BUSE RÉGLABLE TK100
OU003757	8L

photos non contractuelles

**POIGNÉE ÉLECTRIQUE POUR
PULVÉRISATEUR PLASTIQUE GLORIA**

GLORIA

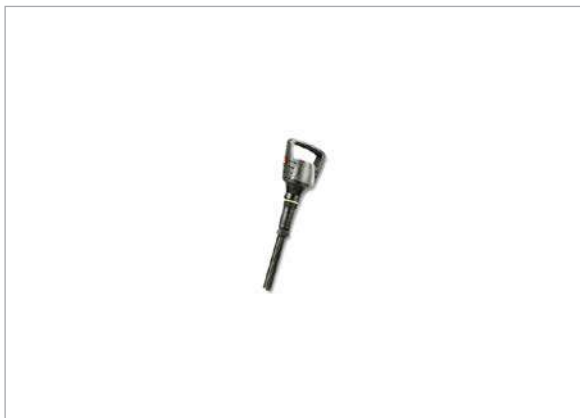

Prévoir 8 piles LR6

RÉF. ART.
OU003674

**LANCE COMPLÈTE POUR
PULVÉRISATEUR**

GLORIA



LANCE POUR PULVERISATEUR AVEC TUYAU ET POIGNEE

RÉF. ART.	DESCRIPTION
OU002691	AVEC TUYAU ET POIGNÉE

JOINT PM POCLETTE

GLORIA



JOINT POUR PULVERISATEUR

RÉF. ART.
OU002490

**LANCE COMPLÈTE TÉLÉSCOPIQUE POUR
PULVÉRISATEUR PRIMA 8**

GLORIA



LANCE TELESCOPIQUE POUR PULVERISATEUR

RÉF. ART.
OU002692

photos non contractuelles

LANCE LAITON



RÉF. ART.	DESCRIPTION
CO002694	D.19MM

LANCE TÉLESCOPIQUE TYPE 132 POUR PULVÉRISATEUR

GLORIA



LANCE TELESCOPIQUE POUR PULVERISATEUR

RÉF. ART.
OU002697

LANCE LAITON GLORIA POUR PULVERISATEUR

GLORIA



LANCE POUR PULVERISATEUR

RÉF. ART.
OU002693

TUYAU PVE ARMÉ D8

TRICOFLEX



RÉF. ART.	DIAMETRE
OU005851	D 8 MM

photos non contractuelles

BROUETTE COFFRE 150L 2 ROUES CHASSIS TUBE

HAEMMERLIN



RÉF. ART.	DESCRIPTION
OU000335	+RENFORT

BROUETTE COFFRE A TUBE RENFORCEE

HAEMMERLIN



RÉF. ART.	DESCRIPTION
OU000336	90L

BROUETTE COFFRE ULTRA RENFORCE CHASSIS TUBE

HAEMMERLIN



RÉF. ART.	DESCRIPTION
OU000340	MONOB EP.1.5 90L

BROUETTE COFFRE, 1 ROUE GONFLABLE

HAEMMERLIN



BROUETTE EXCELLIUM 90L - 1 ROUE GONFLABLE CHARGE UTILE 200KG

RÉF. ART.	DESCRIPTION
OU000339	90L - CHARGE UTILE 200KG

CHARIOT PORTE-PLAQUES

FIMM



Chariot de manutention pour plusieurs plaques - 2 roues $\text{Æ}200\text{mm}$ caoutchouc + 2 roulettes de soutien $\text{Æ}50\text{mm}$ - CMU 400kg - Poids 19kg

RÉF. ART.	DESCRIPTION
OU008585	CMU 400KG

photos non contractuelles

CHARIOT TOUT TERRAIN SUPERDOGGY ROUES INCREVABLES

MATADOR



we
life

Dimensions : L990 x l640 x H350 mm Longueur du manche : 870 mm Poids : 23 kg CMU : 250 kg 6 roues Ø260 mm Possibilité de 3 ridelles (en option : OU100643)

RÉF. ART.

OU100642

RIDELLE POUR CHARIOT TOUT TERRAIN SUPERDOGGY

MATADOR



RÉF. ART.

OU100643

DIABLE

HAEMMERLIN



RÉF. ART.

OU001808

DESCRIPTION

CHARGE UTILE 150KG, ROUE INCRÉVABLE AKXL 250L

DIABLE ELEVATEUR JUMELE

WHIPTRUCK

VOLUME UNIT = 0 M³ - POIDS UNIT = 90 KG

RÉF. ART.

OU103450

DESCRIPTION

CU 1 800 KG

GERBEUR MANUEL

WHIPTRUCK



VOLUME UNIT = 0.286 M³ - POIDS UNIT = 191 KG

RÉF. ART.	DESCRIPTION
OU103449	1000KG LEV 1200 FOURCHES FIXES

LEVE TAMPON LIFTPLAQ

EUROSIGN

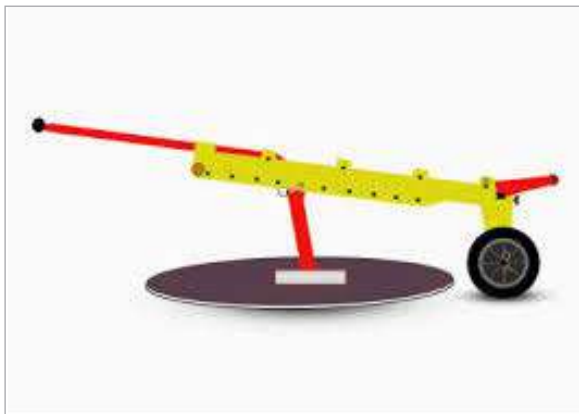

LEVE TAMPON LIFTPLAQ COMPLETAVEC KIT CHAINE ET EL-ARGISSEURDE ROUES

RÉF. ART.	DESCRIPTION
OU10894	COMPLET A/KIT CHAINE ET ELARG. ROUES
OU10884	LEVE TAMPONS LIFTPLAQ VOIRIE/TELECOM

LEVE TAMPONS

EUROSIGN



RÉF. ART.	DESCRIPTION
OU017031	MINI LIFTPLAQ MAGNETIQUE VOIRIE/TELECOM

GAFFE TELESCOPIQUE CROC PLASTIQUE

PLASTIMO



RÉF. ART.	DESCRIPTION
OU017856	0.60 A 0.90M
OU017855	1.20 A 2M

MARTEAU A PLAQUE SEMELLE POLYAMIDE

TALENCO



RÉF. ART.
OU010908



photos non contractuelles

MARTEAU D'ÉGOUTTIER

LEBORGNE



RÉF. ART.

OU002847

LÈVRE PORTE DOORJACK

MATADOR



RÉF. ART.

DESCRIPTION

OU018137

CMU 300KG

PORTE-SEAU ROULANT

MATADOR



RÉF. ART.

DESCRIPTION

OU018138

À CAPACITÉ DE 75KG POUR SEAU DE 10L À 20L

ROULEUR PORTE-PANNEAU

MATADOR



Outil servant à la manutention des portes et panneaux, en guidant uniquement la charge sans la porter - Serrage automatique - Poids : 4,7kg - Dimensions pince : longueur 390mm x largeur d'ouverture max 125mm x hauteur 206mm - 2 roues d.260mm sur essieu d.20mm

RÉF. ART.

DESCRIPTION

OU004013

X AVEC PINCE L.125MM

TRANSPALETTE MANUEL

PRAMAC



RÉF. ART.

DESCRIPTION

OU005452

2,2 T

photos non contractuelles

VENTOUSE À POMPE PORTANTE

STANLEY



VENTOUSE A POMPE FORCE PORTANTE

RÉF. ART.	DESCRIPTION
OU004582	120 KG

ERGO'APP

PÔLE ERGO BYCN

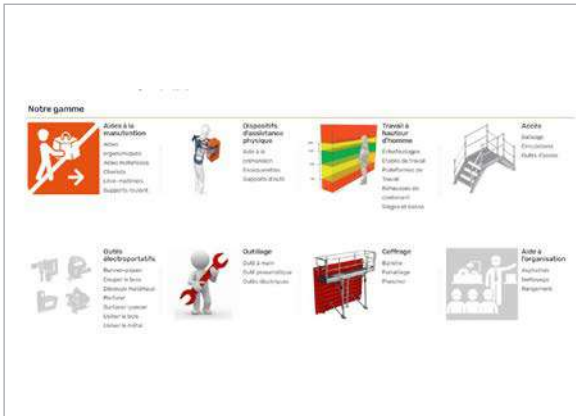

Outil d'aide à la décision permettant d'aider les collaborateurs à choisir les meilleurs outils, matériels ou matériaux selon un besoin et un contexte. Pour chaque produit, l'app propose une carte d'identité détaillée (caractéristiques techniques, photos, liens utiles) et précise pour quel type de tâches il est destiné. Evaluation sur la base de 5 critères : Amélioration de la sécurité, Apport sur la santé, Gain de productivité Intuitivité Poids < 15 kg

RÉF. ART.	DESCRIPTION
ERGO'APP	https://ergoapp.bouygues-construction.com/?lang=fr

SUR COMMANDE = soumis à des délais supérieurs à ceux habituels

SUR COMMANDE = SOUMIS À DES DÉLAIS SUPÉRIEURS À CEUX HABITUELS



RÉF. ART.
SUR COMMANDE

BOX 0 PENIBILITE

DISTRIMO



Gamme évolutive de dispositifs d'assistance physique répondant à un panel de situations standards. La box 0 pénibilité est assortie d'une aide au choix (PDF / Site web) permettant de sélectionner le produit le plus adapté en fonction des contraintes chantiers.

RÉF. ART.	DESCRIPTION
BOX 0 PENIBILITE	Au travers de notre box, nous vous proposons une variété de produits améliorant l'ergonomie et la productivité de certaines tâches sur le chantier. Pour les découvrir, c'est en scannant le QR code ou bien avec le lien : https://bycnmateriel.odoo.com/aides-ergonomiques-et-de-productivite

photos non contractuelles

CÔNE D'ABRAMS

CONTROLAB



INOX

RÉF. ART.

OU001406

AIGUILLE VIBRANTE POUR ÉPROUVETTE

RÉF. ART.

DESCRIPTION

DIAMETRE

OU004827

D.25MM

D 25 MM

MAIN ÉCOPE POUR CÔNE D'ABRAMS

CONTROLAB



RÉF. ART.

OU002746

BALANCE DE PRÉCISION

TIMBER



RÉF. ART.

DESCRIPTION

OU000197

0.5G JUSQU'À 15 KG

ÉPROUVETTE EN CARTON

RÉF. ART.

DESCRIPTION

OU002164

D.16MM L.32MM

PLAQUE EN PVC POUR ESSAI D'ÉTALEMENT SUR BÉTON

PROVITEQ



RÉF. ART.

OU003586

photos non contractuelles

PLAT PYREX 2L POUR TEST SUR CENTRALE À BÉTON

PYREX



RÉF. ART.

OU003626

VERIFIEZ LA DISPONIBILITE DE NOS PRODUITS

DISTRIMO



En scannant le QR code, vérifiez le stock des produits à l'aide des références et de la barre de recherche

RÉF. ART.

DESCRIPTION

SITE WEB

<http://distrimo.bouygues-construction.com/>

photos non contractuelles

AIGUILLE ÉLECTRIQUE 220V AVEC CONVERTISSEUR



RÉF. ART.	DIAMETRE
OU004817	D 36 MM
OU004818	D 50 MM

AIGUILLE VIBRANTE AFP



RÉF. ART.	DESCRIPTION	DIAMETRE
OU004823	AIGUILLE VIBRANTE M35 AFP G	D 36 MM
OU004825	AIGUILLE VIBRANTE M6 AFP G	D 60 MM

AIGUILLE VIBRANTE



RÉF. ART.	DESCRIPTION	DIAMETRE
OU004824	GAINE 5M	D 50 MM

CONVERTISSEUR ELECTRONIQUE BOXEL



POUR AIGUILLES : 2 x diam38 ou 2xdiam50 ou 1xdiam60

RÉF. ART.	DESCRIPTION
OU020816	215 - 2 PRISES
OU020817	225 - 2 PRISES
OU020818	325 - 3 PRISES

RALLONGE POUR AIGUILLES



RÉF. ART.	LONGUEUR
OU005559	L 10 M

VIBREUR À BÉTON,

MAKITA



VIBREUR AUTONOME SUR BATTERIE 18 V Li-Ion 3 Ah

RÉF. ART.	DESCRIPTION
OU008668	BATTERIE 18V LI-ION 3AH

photos non contractuelles

SUPPORT DE SCIE POUR TABLE DE SCIAGE MODELE 2010 ET 2011



REPOSE SCIE A INTEGRER A LA TABLE

RÉF. ART.

OU004151

TABLE DE SCIAGE GALVA MOD 2011



PERMET DE SCIER OU TRONCONNER EN SECURITE, 4 PIEDS REGLABLES, TABLETTE REPOSE SCIE

RÉF. ART.

OU004177

DESCRIPTION

+ SUPP DE SCIE ET PIEDS REGL

TRÉTEAU DE MAÇON

SODIMAT



PREVOIR GARDE CORPS POUR TRETEAU DE MACON

RÉF. ART.

OU004526

GARDE CORPS TRETEAUX

SODIMAT



POUR REF AE401

RÉF. ART.

OU002335

TRÉTEAU PLIANT EN BOIS

GOUVY



RÉF. ART.	DESCRIPTION
OU004525	HÊTRE L.80CM

SOLUTION RECYCLAGE CASQUES ELECTROPORTATIFS



RÉF. ART.
RECYCLAGE

TRANSPORT EXPRESS

LE SERVICE TRANSPORT EXPRESS SUR MESURE VOUS ASSURE L'ENLÈVEMENT ET LA LIVRAISON DE COLIS, PLANS, PALETTES ET HORS-GABARIT DANS LES DÉLAIS LES PLUS COURTS.



RÉF. ART.	DESCRIPTION
Transport express	L.BONAVENTURE@bouygues-construction.com j.imboden@bouygues-construction.com

Une idée de nouveau produit ?



RÉF. ART.	DESCRIPTION
NOUVEAU PRODUIT	mailto:t.bobin@bouygues-construction.com

photos non contractuelles

BANC AGENOUILLOIR PLIABLE EN MÉTAL

SPEAR ET JACKSON

we
life

Ce modèle s'utilise dans 2 positions : comme un banc, ou bien comme un coussin, au ras du sol - Pratique, sa structure métallique est pliable afin de le ranger même dans les plus petits espaces. Dim. plié : H28cm x L13cm x l60cm - Hauteur banc déplié : 48cm

RÉF. ART.	DESCRIPTION
OU000198	L.60CM L.13CM

COUSSIN KNEELO POUR PROTÈGE-GENOUX

COUSSIN IDÉAL POUR RENDRE LE TRAVAIL À GENOUX RÉGULIER PLUS CONFORTABLE - POIDS : 325G - MATIÈRE : MOUSSE À MÉMOIRE DE FORME AVEC REVÊTEMENT EXTERNE EN NÉOPRÈNE IMPERMÉABLE - DIMENSIONS : 500 X 300 X 50MM - COULEUR SELON ARRIVAGE (ROUGE OU VERT)

we
life

RÉF. ART.
OU007808

SIÈGE ERGONOMIQUE POUR TRAVAIL À GENOUXwe
life

Permet une position ergonomique de grand confort. Siège réglable en hauteur et inclinaison pour une adaptation optimale à chaque utilisation. Structure robuste avec 7 roues de grande résistance. Genouillères ergonomiques remplaçables. Poids maxi : 130 kg.

RÉF. ART.
OU004115

TAPIS REPOSE-GENOUX PLIABLE EN MOUSSE

CARPENTER



dimensions : dépliée (H370 x L290 x ep15mm) - pliée (H290 x L100 x ep60mm) - mousse de polyoléfine noire - Tapis pliable destiné aux personnes travaillant à genoux de manière épisodique.

RÉF. ART.
OU004219

photos non contractuelles

DRAPEAU BOUYGUES TP



RÉF. ART.	LONGUEUR	LARGEUR
SI005517	L 300 CM	I 150 CM

DRAPEAU DE FRANCE



RÉF. ART.	LONGUEUR	LARGEUR
SI001954	L 225 CM	I 150 CM

DRAPEAU DE BYBAT IDF



RÉF. ART.	LONGUEUR	LARGEUR
SI001951	L 300 CM	I 200 CM

DRAPEAU DE BYCN SERVICE NUCLÉAIRE



RÉF. ART.	LONGUEUR	LARGEUR
SI005904	L 300 CM	I 150 CM

photos non contractuelles

AUTOCOLLANT BOUYGUES TP



RÉF. ART.	LONGUEUR	LARGEUR
SI005996	L 100 CM	I 50 CM
SI005997	L 200 CM	I 100 CM
SI005999	L 22 CM	I 11 CM
SI006000	L 44 CM	I 22 CM
SI006006	L 50 MM	I 25 MM

AUTOCOLLANT BYBAT IDF



RÉF. ART.	LONGUEUR	LARGEUR
SI000133	L 100 CM	I 70 CM
SI005955	L 22 CM	I 16,5 CM
SI005956	L 44 CM	I 29,5 CM
SI006007	L 50 MM	I 25 MM

AUTOCOLLANT BYBAT POUR PANCARTE GRUE

POUR PANCARTE GRUE 200 X 100 CM



RÉF. ART.	LONGUEUR	LARGEUR
SI009668	L 200 CM	I 100 CM

AUTOCOLLANT BYBAT POUR PANCARTE



RÉF. ART.	LONGUEUR	LARGEUR
SI000135	L 300 CM	I 150 CM

AUTOCOLLANT BYCN SERVICE NUCLÉAIRE

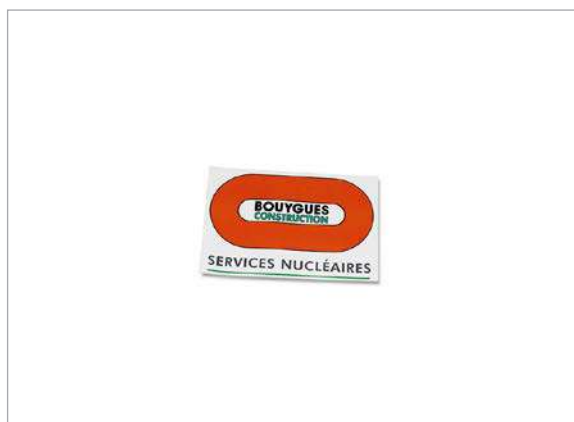

RÉF. ART.	LONGUEUR	LARGEUR
SI006017	L 220 MM	I 165 MM
SI006018	L 440 MM	I 295 M
SI006016	L 50 MM	I 30 MM

photos non contractuelles

AUTOCOLLANT BYES



RÉF. ART.	LONGUEUR	LARGEUR
SI010877	L 110 MM	I 55 MM
SI010878	L 165 MM	I 110 MM
SI010879	L 220 MM	I 110 MM
SI010880	L 440 MM	I 220 MM
SI010876	L 50 MM	I 25 MM

AUTOCOLLANT BOUYGUES TP

AUTOCOLLANT BYTP SANS LA BOUÉE POUR PANNEAU 1.50X3ML FOND BLANC



RÉF. ART.	DESCRIPTION	LONGUEUR	LARGEUR
SI017222	AUTOLLANT BYTP 1,50X3ML	3ml	1,50ml

BANDE LISERET ORANGE



RÉF. ART.	DESCRIPTION	LONGUEUR	LARGEUR
SI000207	L.120CM L.15CM	L 120 CM	I 5 CM

photos non contractuelles

AUTOCOLLANT POUR CASQUE DE CONDUCTEUR D'ENGIN



RÉF. ART.	DIAMETRE
SI000156	D 40 MM

AUTOCOLLANT POUR CASQUE D'ÉLECTRICITÉ



RÉF. ART.	DIAMETRE
SI005991	D 40 MM

AUTOCOLLANT POUR CASQUE DE GRUTIER



RÉF. ART.	DIAMETRE
SI010009	D 40 MM

AUTOCOLLANT POUR CASQUE DE CHARIOT ÉLÉVATEUR



RÉF. ART.	DIAMETRE
SI005990	D 40 MM

AUTOCOLLANT POUR CASQUE D'ÉCHAUFFEMENT SPORTIF



RÉF. ART.	DIAMETRE
SI010010	D 40 MM

AUTOCOLLANT POUR CASQUE DE CHEF DE MANOEUVRE



RÉF. ART.	DIAMETRE
SI010011	D 40 MM

photos non contractuelles

AUTOCOLLANT POUR CASQUE DE HARNAIS



RÉF. ART.	DIAMETRE
SI010023	D 40 MM

AUTOCOLLANT POUR CASQUE D'HABILITÉ ÉLECTROPORTATIF



RÉF. ART.	DIAMETRE
SI000158	D 40 MM

AUTOCOLLANT POUR CASQUE DE PONT ROULANT



RÉF. ART.	DIAMETRE
SI005992	D 40 MM

AUTOCOLLANT POUR CASQUE D'HABILITÉ NACELLE



RÉF. ART.	DIAMETRE
SI000159	D 40 MM

AUTOCOLLANT POUR CASQUE D'HABILITÉ ÉCHAFAUDAGE



RÉF. ART.	DIAMETRE
SI000157	D 40 MM

AUTOCOLLANT POUR CASQUE D'HABILITÉ SST



RÉF. ART.	DESCRIPTION	DIAMETRE
SI000160	À L'UNITÉ	D 40 MM

photos non contractuelles

AUTOCOLLANT INTERDICTION DE



RÉF. ART.	DESCRIPTION	LONGUEUR	LARGEUR
SI006014	FUMER	L 21 CM	I 15 CM
SI017859	FUMER, VAPOTER	L 29,7CM	I 21 CM

AUTOCOLLANT SECOURISTE



RÉF. ART.	DESCRIPTION	LONGUEUR	LARGEUR
SI005957	AUTOCOLLANT SECOURISTÉ D.40MM	L 12 CM	I 2 CM

STICKER MANUTENTION DE 15 A 25KGS

AUTOCOLLANT SAFETY VALIDÉ BYCN POUR LE POIDS DES MATÉRIELS. JAUNE, DIAMÈTRE 5CM

DE 15 À 25KG



RÉF. ART.	DESCRIPTION
SI018385	- JAUNE D. 5CM

STICKER MANUTENTION MANUELLE

AUTORISEE <15kg

AUTOCOLLANT SAFETY VALIDÉ BYCN POUR LE POIDS DES MATÉRIELS. VERT, DIAMÈTRE 5CM

INFÉRIEUR À 15KG

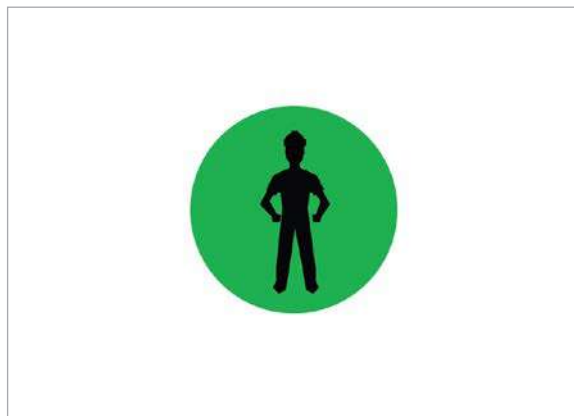

RÉF. ART.	DESCRIPTION
SI018384	- VERT D. 5CM

STICKER MANUTENTION SUPERIEURE A 25 KGS

AUTOCOLLANT SAFETY VALIDÉ BYCN POUR LE POIDS DES MATÉRIELS. ROUGE NOIR, DIAMÈTRE 5CM

SUPÉRIEUR À 25KG

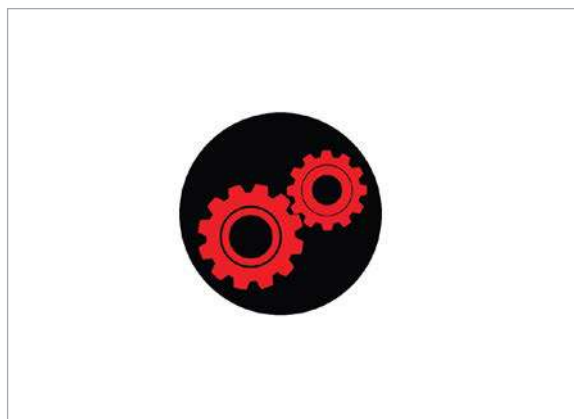

RÉF. ART.	DESCRIPTION
SI018386	- ROUGE NOIR D. 5CM

photos non contractuelles

**FLECHE DIRECTIONNELLE BOUYGUES
BATIMENT ILE DE FRANCE**



RÉF. ART.	LONGUEUR	LARGEUR
SI005994	L 60 CM	I 20 CM

FLECHE DIRECTIONNELLE BY BAT NORD-EST



RÉF. ART.	LONGUEUR	LARGEUR
SI002290	L 60 CM	I 20 CM

**FLECHE DIRECTIONNELLE BY BAT
CENTRE SUD-OUEST**



RÉF. ART.	LONGUEUR	LARGEUR
SI002288	L 60 CM	I 20 CM

FLECHE DIRECTIONNELLE BY BAT SUD-EST



RÉF. ART.	LONGUEUR	LARGEUR
SI009655	L 60 CM	I 20 CM

**FLECHE DIRECTIONNELLE BY BAT GRAND
OUEST**



RÉF. ART.	LONGUEUR	LARGEUR
SI005995	L 60 CM	I 20 CM

PANCARTE BOUÉE MINORANGE

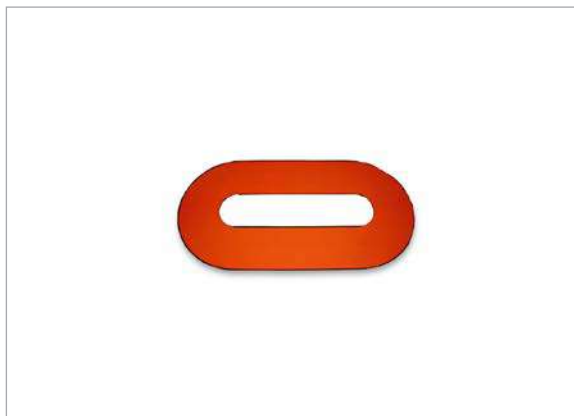

RÉF. ART.	LONGUEUR	LARGEUR
SI003355	L 100 CM	I 50 CM
SI003356	L 200 CM	I 100 CM

photos non contractuelles

PANNEAU BOUYGUES TP

RÉF. ART.	LONGUEUR	LARGEUR	EPAISSEUR
SI005947	L 300 CM	I 150 CM	Ep 10 MM

PANNEAU BYBAT IDF



RÉF. ART.	DESCRIPTION	LONGUEUR	LARGEUR	EPAISSEUR
SI003358	EN PVC L.100CM L.75CM EP.5MM	L 100 CM	I 75 CM	Ep 10 MM
SI005952	L.220CM L.150CM EP.10MM			Ep 10 MM
SI005950				Ep 10 MM

PANNEAU BYBAT

MONTE SUR CADRE METAL

RÉF. ART.	DESCRIPTION	EPAISSEUR
SI005948	L.300MM L.150MM EP.10MM	Ep 10 MM

PANNEAU ZÉRO ACCIDENT BYBAT



RÉF. ART.	DESCRIPTION
SI005943	HABITAT RÉSIDENTIEL
SI005937	HAS

photos non contractuelles

AFFICHAGE PLANNING HEBDOMADAIRE + 700 FICHES



RÉF. ART.
SI000052

AIMANT DE TABLEAU



RÉF. ART.
SI000059

FICHES PLANNING INDICE 2 MULTI-COULEURS

EN PAQUET DE CENT PLUSIEURS COLORIS



RÉF. ART.
SI002242

MARQUEUR



RÉF. ART. DESCRIPTION
SI002843 TABLEAU BLANC - Pochette de 4

PANNEAU CHSCT

AVEC AIMANTS



RÉF. ART. DESCRIPTION
SI005624 L.3x1x0,8M AVEC FOND AFFICHAGE+AIMANTS

ADHÉSIF PANNEAU D'AFFICHAGE



RÉF. ART.
SI006001

photos non contractuelles

PANNEAU D’AFFICHAGE

RÉF. ART.	LONGUEUR	LARGEUR
SI007346	L 100 CM	I 80 CM

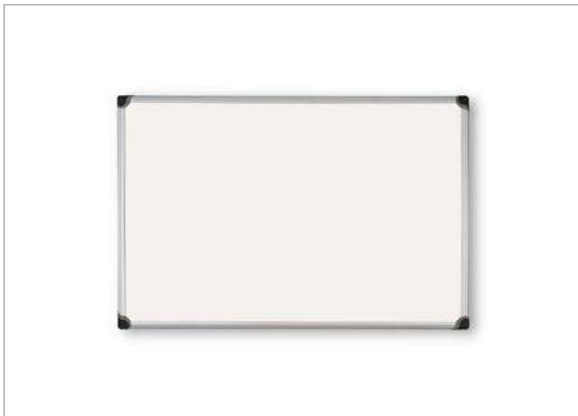
TABLEAU BLANC

RÉF. ART.	DESCRIPTION
SI004182	90X120CM NON MAGNETIQUE

photos non contractuelles

DANGER ATMOSPHERE EXPLOSIVE

TALIAPLAST



RÉF. ART.	DESCRIPTION
SI103447	100X100X100MM

DANGER FLAMME NUE MATIERE INFLAMMABLE

TALIAPLAST



RÉF. ART.	DESCRIPTION
SI103446	100X100X100MM

FLECHE DIRECTIONNELLE VIERGE

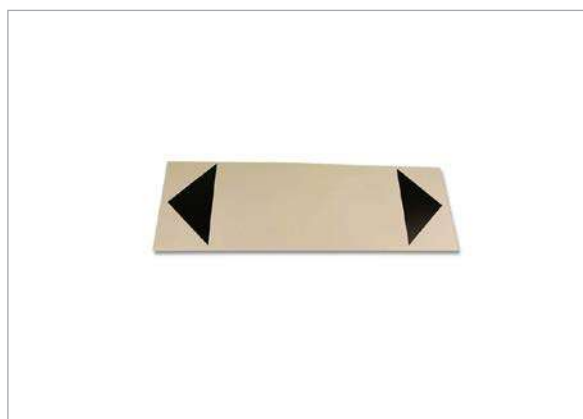

RÉF. ART.	DESCRIPTION	LONGUEUR	LARGEUR
SI002291	600X200	L 60 CM	I 20 CM

PANNEAU AK14 "POINT D'EXCLAMATION"

SES NOUVELLE



RÉF. ART.	DESCRIPTION
SI103555	1000MM CL2
SI103541	1250MM CL2

PANNEAU AK17 FEU TRICOLORE

SES NOUVELLE



RÉF. ART.	DESCRIPTION
SI103556	PANNEAU AK17 "FEU TRICOLORE" 1000MM CL2
SI103542	PANNEAU AK17 "FEU TRICOLORE" 1250MM CL2

photos non contractuelles

PANNEAU AK22 PROJECTION

SES NOUVELLE



RÉF. ART.	DESCRIPTION
SI103557	PANNEAU AK22 "PROJECTION" 1000MM CL2
SI103543	PANNEAU AK22 "PROJECTION" 1250MM CL2

PANNEAU AK5 TRAVAUX

SES NOUVELLE



RÉF. ART.	DESCRIPTION
SI103554	PANNEAU AK5 "TRAVAUX" 1000MM CL2
SI103546	PANNEAU AK5 "TRAVAUX" 1250MM CL2

PANNEAU AK3 RETRECISSEMENT

SES NOUVELLE



RÉF. ART.	DESCRIPTION
SI103552	1000MM CL2
SI103544	1250MM CL2

PANNEAU B15 SENS PRIORITAIRE

SES NOUVELLE



RÉF. ART.	DESCRIPTION
SI103549	PANNEAU B15 "SENS PRIORITAIRE" Ø1050MM CL2
SI103562	PANNEAU B15 "SENS PRIORITAIRE" Ø850MM CL2

PANNEAU AK4 CHAUSSEE GLISSANTE

SES NOUVELLE



RÉF. ART.	DESCRIPTION
SI103553	PANNEAU AK4 "CHAUSSEE GLISSANTE" 1000MM CL2
SI103545	PANNEAU AK4 "CHAUSSEE GLISSANTE" 1250MM CL2

PANNEAU B21 FLECHE PIVOTANTE

SES NOUVELLE



RÉF. ART.	DESCRIPTION
SI103548	Ø1050MM CL2
SI103568	Ø850MM CL2

photos non contractuelles

PANNEAU B3 LIMITE 30 KM/H

SES NOUVELLE



RÉF. ART.	DESCRIPTION
SI103565	PANNEAU B3 " LIMITE 30 KM/H" Ø1050MM CL2
SI103559	PANNEAU B3 " LIMITE 30 KM/H" Ø850MM CL2

PANNEAU B3 INTERDICTION DE DEPASSER

SES NOUVELLE



RÉF. ART.	DESCRIPTION
SI103564	PANNEAU B3 "INTERDICTION DE DEPASSER" Ø1050MM CL2
SI103558	PANNEAU B3 "INTERDICTION DE DEPASSER" Ø850MM CL2

PANNEAU B3 LIMITE 50 KM/H

SES NOUVELLE



RÉF. ART.	DESCRIPTION
SI103566	PANNEAU B3 " LIMITE 50 KM/H" Ø1050MM CL2
SI103560	PANNEAU B3 " LIMITE 50 KM/H" Ø850MM CL2

PANNEAU B31 FIN LIMITATION VITESSE

SES NOUVELLE



RÉF. ART.	DESCRIPTION
SI103550	PANNEAU B31 "FIN LIMIT VIT" Ø1050MM CL2
SI103563	PANNEAU B31 "FIN LIMIT VIT" Ø850MM CL2

PANNEAU B3 LIMITE 70 KM/H

SES NOUVELLE



RÉF. ART.	DESCRIPTION
SI103567	PANNEAU B3 " LIMITE 70 KM/H" Ø1050MM CL2
SI103561	PANNEAU B3 " LIMITE 70 KM/H" Ø850MM CL2

photos non contractuelles

PANNEAU C18 PRIORITE EN FACE

SES NOUVELLE



RÉF. ART.	DESCRIPTION
SI103569	PANNEAU C18 "PRIORITE EN FACE" 700MM CL2
SI103551	PANNEAU C18 "PRIORITE EN FACE" 9700MM CL2

PANNEAU FIN DE CHANTIER

SES NOUVELLE

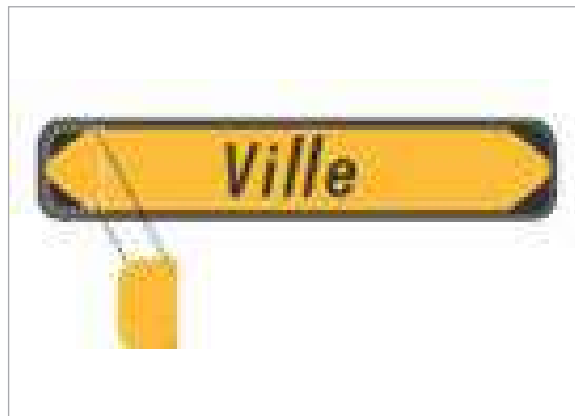

RÉF. ART.	DESCRIPTION
SI103574	PANNEAU K2 "FIN DE CHANTIER" 1400X200 CL2

PANNEAU CHANTIER INTERDIT AU PUBLIC



RÉF. ART.	DESCRIPTION
SI005518	

PANNEAU K8 CLASSE 2

SES NOUVELLE

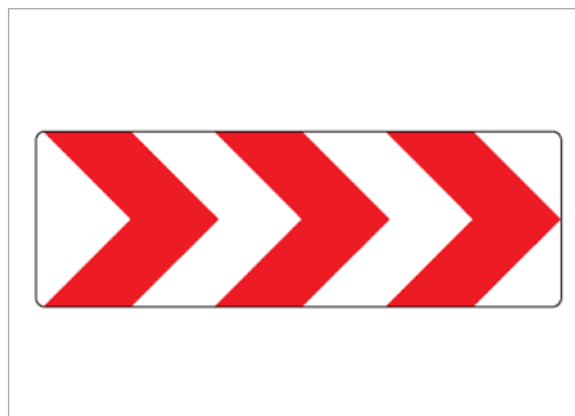

RÉF. ART.	DESCRIPTION
SI103547	1500X500

PANNEAU DÉFENSE DE PASSER SOUS LA CHARGE



RÉF. ART.	LONGUEUR	LARGEUR
SI005905	L 33 CM	I 20 CM

PANNEAU KC1 CIRCULATION ALTERNEE

SES NOUVELLE



RÉF. ART.	DESCRIPTION
SI103571	PANNEAU KC1 "CIRCULATION ALTERNEE" 800X600 CL2

photos non contractuelles

PANNEAU KC1 ROUTE BARREE

SES NOUVELLE



RÉF. ART.	DESCRIPTION
SI103572	PANNEAU KC1 "ROUTE BARREE" 800X600 CL2

PANNEAU KD22A VILLE

SES NOUVELLE



RÉF. ART.	DESCRIPTION
SI103576	PANNEAU KD22A "VILLE" POINTE AMOVIBLE 1000X300 CL2
SI103577	PANNEAU KD22A "VILLE" POINTE AMOVIBLE 1300X300 CL2

PANNEAU KC1 SORTIE DE CHANTIER

SES NOUVELLE



RÉF. ART.	DESCRIPTION
SI103573	PANNEAU KC1 "SORTIE DE CHANTIER" 800X600 CL2

PANNEAU CHANTIER MOBILE

SES NOUVELLE



RÉF. ART.	DESCRIPTION
SI103570	PANNEAU KM9 "CHANTIER MOBILE" 700X200 CL2

PANNEAU KD22A DEVIATION

SES NOUVELLE



RÉF. ART.	DESCRIPTION
SI103575	PANNEAU KD22A "DEVIATION" POINTE AMOVIBLE 1000X300 CLE 2

PANNEAU MAGNÉTIQUE DE SIGNALISATION "SERVICE"



RÉF. ART.	DESCRIPTION
SI010813	"

photos non contractuelles

PANNEAU PERMIS DE CONSTRUIRE



RÉF. ART.	LONGUEUR	LARGEUR
SI003363	L 50 CM	I 15 CM

PANNEAU PORT DE CHAUSSURES



RÉF. ART.	DESCRIPTION	DIAMETRE
SI003367	EN PVC BLEU	D 29 MM

PANNEAU PERMIS DE DÉMOLIR



RÉF. ART.
SI003364

PANNEAU PORT DE LUNETTES OBLIGATOIRE



RÉF. ART.	LONGUEUR	LARGEUR
SI005906	L 33 CM	I 20 CM

PANNEAU PIÉTONS TRAVERSÉE OBLIGATOIRE



RÉF. ART.	DESCRIPTION	LONGUEUR	LARGEUR
SI005934	+ FLÈCHE 600x300x100	L 60 CM	I 30 CM

PANNEAU PORT DU CASQUE OBLIGATOIRE



RÉF. ART.	LONGUEUR	LARGEUR
SI005908	L 33 CM	I 20 CM

photos non contractuelles

PANNEAU PORT PROTECTION AUDITIVE OBLIGATOIRE



RÉF. ART.	DIAMETRE
SI005931	D 29 MM

PANNEAU SENS OBLIGATOIRE



RÉF. ART.	DIAMETRE
SI005913	D 29 MM

PANNEAU PVC ACCÈS À CHANTIER



RÉF. ART.	LONGUEUR	LARGEUR
SI005941	l 60 CM	l 30 CM

PANNEAU SORTIE DE CAMION



RÉF. ART.	LONGUEUR	LARGEUR
SI005907	L 33 CM	l 20 CM

PANNEAU SENS INTERDIT



RÉF. ART.	DESCRIPTION	EPAISSEUR	DIAMETRE
SI005912	PVC	Ep 10 MM	D 29 MM

PANNEAU STATIONNEMENT INTERDIT



RÉF. ART.	LONGUEUR	LARGEUR
SI005909	L 33 CM	l 20 CM

photos non contractuelles

PANNEAU STOP



RÉF. ART.	DESCRIPTION	DIAMETRE
SI005910	PVC D.29MM	D 29 MM

PANNEAU TRAVAUX AK5 CLASSE 1



RÉF. ART.	DESCRIPTION	EPAISSEUR
SI010902	1000MM AVEC SUPPORT	
SI005920	700MM AVEC SUPPORT	H 100 CM

PIQUET K10 CIRCULATION ALTERNEE

SES NOUVELLE

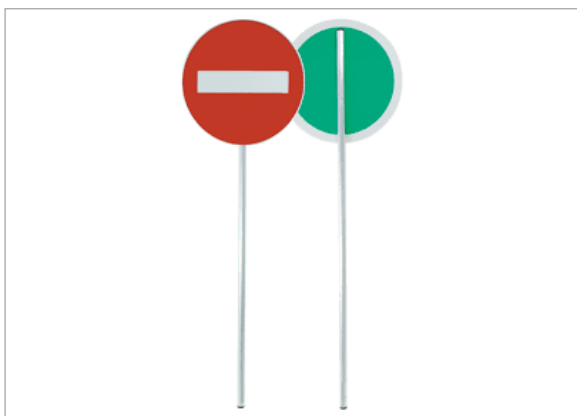

RÉF. ART.	DESCRIPTION	EPAISSEUR
SI103606	PIQUET K10 Ø420MM MANCHE 1400	H 70 CM

PIQUET SIGNALISATION DOUBLE

CAUPAMAT



RÉF. ART.	DESCRIPTION
SI103607	PIQUET SIGNALISATION K5B DOUBLE FACE 375X150X1000 CLASSE 2
SI103608	PIQUET SIGNALISATION K5C DOUBLE FACE 375X150X1000 CLASSE 2

photos non contractuelles

CHAÎNE PLASTIQUE N°8 ROUGE ET BLANCHE

SOFOPL TALIAPLAST

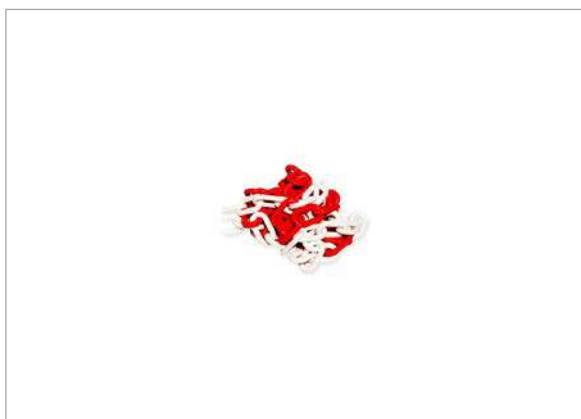

RÉF. ART.	COULEUR	DIAMÈTRE
SI000508	ROUGE/BLANC	D 8 MM

MAILLON PLASTIQUE N°8

VINMER



RÉF. ART.
SI002744

CHAÎNE PLASTIQUE N°8 VERTE POUR PIÉTONS

SOFOPL TALIAPLAST



RÉF. ART.	DESCRIPTION	COULEUR	DIAMÈTRE
SI000507	D.8MM	VERT	D 8 MM

CLÔTURE ORANGE M



RÉF. ART.	DESCRIPTION
SI001015	H.1M L.50

CONE BALISAGE PLASTIQUE 300MM

VINMER



RÉF. ART.	DESCRIPTION	EPAISSEUR
SI001400	CONE BALISAGE PLASTIQUE	H 100 CM

CONE BALISAGE PLASTIQUE 500 MM

VINMER



RÉF. ART.	DESCRIPTION	EPAISSEUR
SI001401	AVEC LOGO BYES	H 300 MM
SI001402	CONE BALISAGE PLASTIQUE 500MM	H 500 MM

photos non contractuelles

CONE BALISAGE PLASTIQUE 750MM

VINMER



RÉF. ART.	DESCRIPTION	EPAISSEUR
SI001405		H 500 MM
SI017875	AVEC LOGO BYES	H 750 MM

BARRIERE DE CHANTIER STANDARD

SODIMAT



RÉF. ART.	DESCRIPTION	EPAISSEUR
IN000215	D.25MM ROUGE ET BLANCHE + PLAQUE	H 750 MM

BARRIERE EXTENSIBLE ENTRE CÔNES

LONGUEUR : EXTENSIBLE DE 1,20M À 2,40M

MATIÈRE : PVC TUBULAIRE

FINITION : FILM RÉTRO-RÉFLÉCHISSANT, CLASSE 1 ROUGE ET BLANC



RÉF. ART.	DESCRIPTION	LONGUEUR
SI010588	L.120-240CM	L 120/240 CM



RUBALISE CHANTIER LONG 500M "AMIANTE" ROUGE ET BLANC

SEBEMEX



RÉF. ART.
SI018280



photos non contractuelles

RUBALISE INDÉCHIRABLE EN TISSU

SOFOP TALIAPLAST



RÉF. ART.	DESCRIPTION	LARGEUR
SI004014	L.50M L.50MM	150 MM

PIQUET D.14 MM

RÉF. ART.	DESCRIPTION	LONGUEUR	DIAMETRE
SI003556	PIQUET DROIT	L 100 CM	D 14 MM
SI003559	PIQUET ISOLFICHE	L 130 CM	D 14 MM

RUBALISE PVC

RÉF. ART.	DESCRIPTION	LARGEUR
SI017775	JAUNE/NOIR 50 MM X 100 M	
SI007978	RENFORCÉE L.100M L.50MM	150 MM

PIQUET PORTE-LANTERNE D.14MM

SODIMAT



RÉF. ART.	DESCRIPTION	LONGUEUR	DIAMETRE
SI003560	PIQUET PORTE-LANTERNE	L 130 CM	D 14 MM
SI008615	PIQUET PORTE-LANTERNE ISOLÉ	L 130 CM	D 14 MM

PIQUET BOIS D.40MM

RÉF. ART.	DESCRIPTION	LONGUEUR	DIAMETRE
SI003554	PIQUET BOIS	L 100 CM	D 40 MM
SI003553		L 50 CM	D 40 MM

POTEAU SUR SOCLE ROUGE/BLANC

SOFOP TALIAPLAST



RÉF. ART.
IN003730

photos non contractuelles

PRATTIK 500 BLANC

AXIMUM



- HT 500 ET LG UTILE 1000 MM - 1130X500 MM - LIAISONS INTÉGRÉES - CLASSE A

RÉF. ART.	DESCRIPTION
SI103448	- EMPILABLE ET LESTABLE

SEPARATEUR DE VOIES K16

RÉF. ART.	DESCRIPTION	REFERENCE FABRICANT
IN112967	BLANC	52 05 22
IN112968	ROUGE	

photos non contractuelles

ETIQUETTE

POUR ETIQUETAGE ET MARQUAGE DIVERS



RÉF. ART.	DESCRIPTION	LONGUEUR	LARGEUR
SI002198	BLANCHE		
SI006005	BLEU		
SI006004	JAUNE		
SI005521	PLASTIQUE VERTE AVEC TROU	L 110 MM	I 55 MM
SI005522	ROUGE		

BOITE COMPARTIMENTEE POUR KIT OBAYA

IFD



21 CASES 18 SEPARATEURS AMOVIBLES

RÉF. ART.	DESCRIPTION
SI105753	BOITE COMPARTIMENTEE 38 X 26,5 X 5 CM POUR KIT OBAYA

LOT DE 25 PLANCHES DE 35 ETIQUETTES POUR KIT OBAYA

LYRECO

ETIQUETTES AVERY L7120-2

RÉF. ART.
SI105751

LOT DE 63 MAGNETS POUR KIT OBAYA

MAGNET DECO

MAGNET FORCE 93GR/CM2

RÉF. ART.	DESCRIPTION
SI105752	LOT DE 63 MAGNETS 35X35MM EP.2MM POUR KIT OBAYA

photos non contractuelles

**WIZOM REHABILITATION LOT DE 200
STICKS PORTE**

RÉF. ART.	LONGUEUR	LARGEUR
SI020228	190MM	120MM
SI020225	190MM	120MM
SI020229	190MM	120MM
SI020226	190MM	120MM
SI020227	190MM	120MM
SI020230	190MM	120MM

La marque Distrimo[©]

Partenaire de vos chantiers, la marque de Distribution de Bouygues Construction Matériel a pour mission de fournir de l'outillage, des consommables et des EPI avec une vraie valeur ajoutée (prix/services). Pour cela, nous nous appuyons sur :

un approvisionnement au plus court chez les fabricants en utilisant notre statut de négociateur

une centralisation des volumes à partir d'un référencement effectué avec Bouygues Construction Purchasing

un fonctionnement simple et transparent : un catalogue commun pour nos clients France et International et des prix franco tout chantier France métropolitaine avec une logistique adaptée aux utilisateurs

SNAMO
(Tourville La Rivière)
1986
SNAMO

CRP DISTRI
(Chilly-Mazarin)
2001
CRP DISTRI

DISTRIMO
(Fusion SNAMO / CRP DISTRI)
2005

La marque DISTRIMO[©]
2020



DISTRIMO

la marque de distribution de



Depuis le 1er janvier 2020, DISTRIMO est devenu la Direction Equipement Distribution-Négoce de BYCN Matériel et a déposé la marque DISTRIMO®



La politique Santé Sécurité de Bouygues Construction fait partie intégrante de la renommée du groupe

Afin de répondre à ses exigences, les produits référencés Santé Sécurité proposés par Distrimo sont considérés comme des standards en terme de sécurité et d'ergonomie. Ces produits promettent alors à l'utilisateur final le respect du cahier des charges Bouygues Construction.

Pour représenter l'appartenance au groupe, le nouveau logo Distrimo est composé du monogramme D reprenant la moitié de la bouée du logo BOUYGUES. Ce monogramme D est entouré d'un cercle ayant pour objectif de représenter «un coup de tampon».

Ce symbole fait référence à la conformité des standards Santé/Sécurité de Bouygues Construction des produits Distrimo.

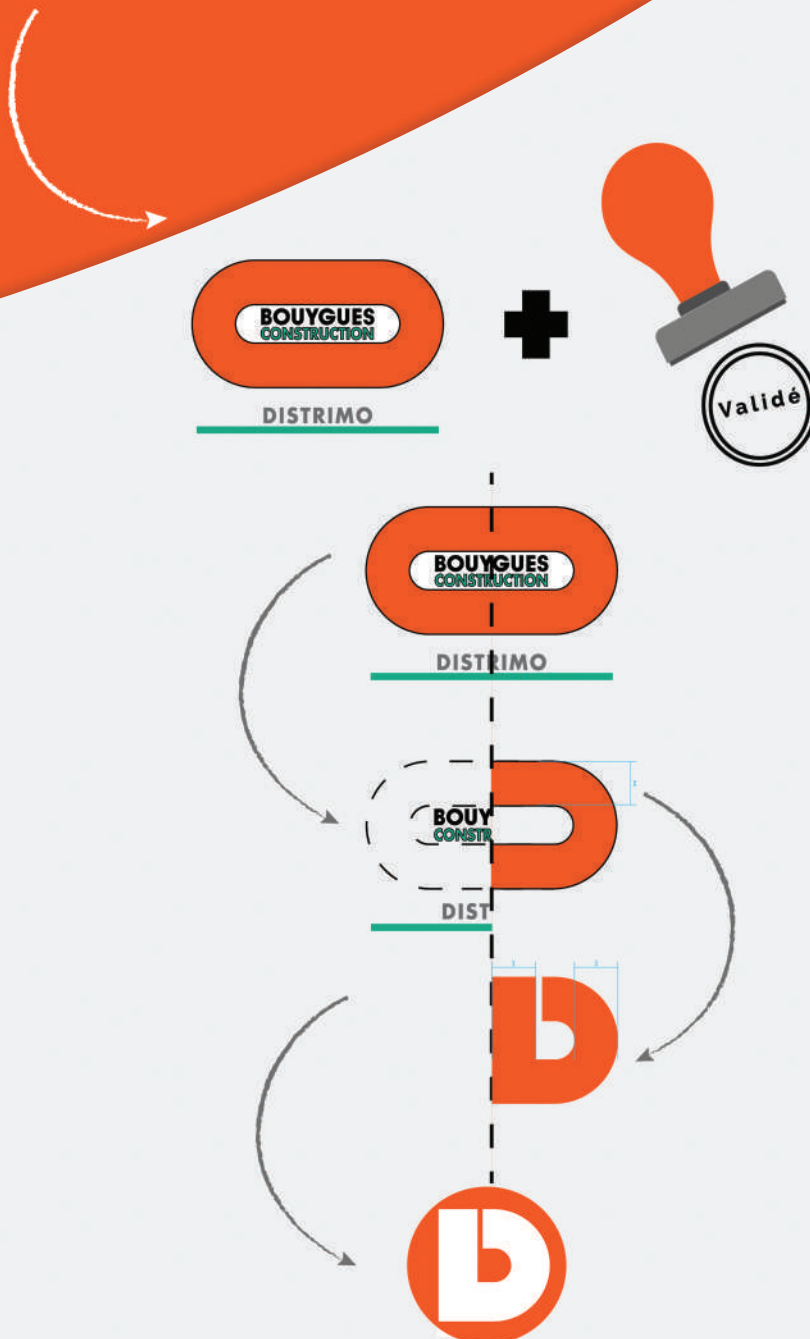

Notre savoir-faire

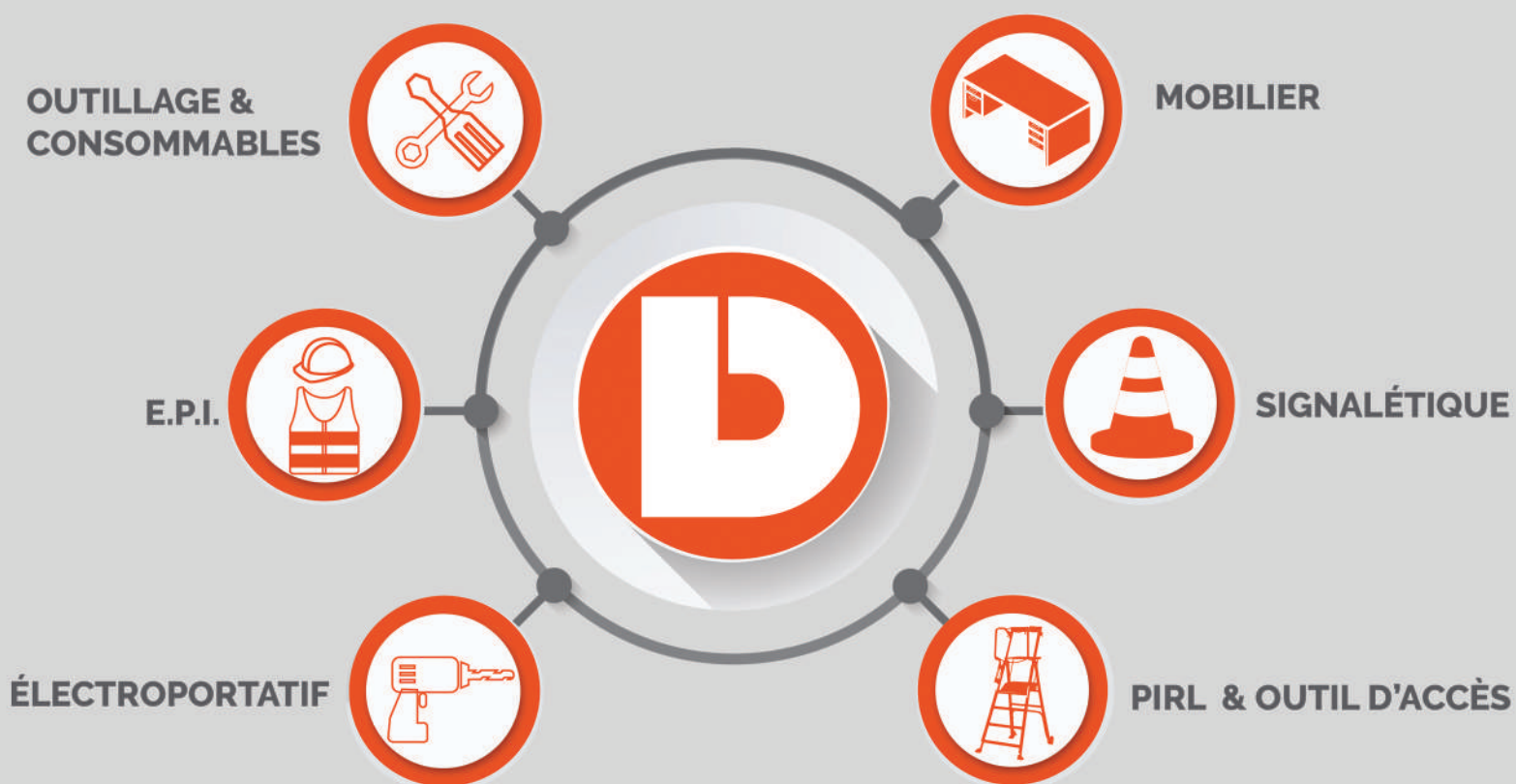

+ 6000 références
en stock



Des conseillers
techniques à votre écoute



Franco de port*
* France métropolitaine



100 % garant des produits
Santé Sécurité Bouygues
Construction

Nos services

Nous cherchons à satisfaire nos clients de la meilleure manière qu'il soit, jour après jour grâce à la palette de services suivante :

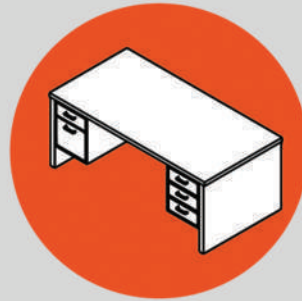

**MONTAGE
MOBILIER**



**PAQUETAGE
INDIVIDUEL**



**TRANSPORT
EXPRESS**



DISTRIPUS⁺

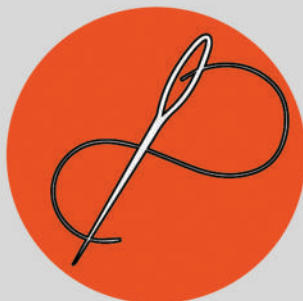

BRODERIE



**SOLUTIONS
RECYCLAGE**

Nos services



PAQUETAGE INDIVIDUEL



Un packaging d'EPI unique par collaborateur : produits, taille, logo, entité, nom



5000 collaborateurs équipés par an sur **13** entités du groupe



Rapidité et facilité :
Distrimo gère les dossiers entièrement



Ouvert à toutes les filiales du Groupe.
Compositions différentes en fonction de l'entité

EPI



BRODERIE

Nous vous proposons des prestations broderie ! Comment ça marche ? Envoyez nous votre motif, dites-nous sur quel EPI vous voulez faire ce marquage et à quel endroit, et nous vous envoyons un devis.

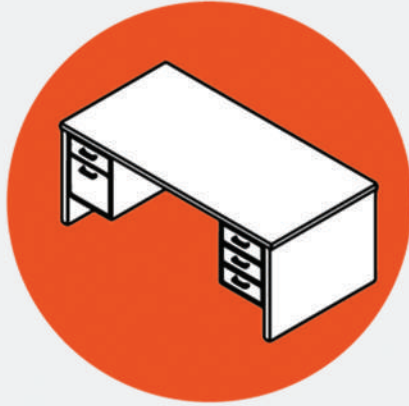

MONTAGE MOBILIER

A partir d'un montant de 1200€ d'achat de mobilier,
Mobika dépêche une équipe pour :
Décharger le(s) camion(s)

Installer en RDC ou R+1 les mobiliers commandés*

Evacuer tous les déchets

Ce service constitue un supplément de 8% (en Ile de France et 10% (en province) de la commande de mobilier (ligne supplémentaire en générique dans PABLO).

*Si plus haut que R+1 ou dans l'existant, merci de contacter votre interlocuteur ou interlocutrice Distrimo afin de réaliser un devis d'installation



MOBIKA

Enlèvements et livraisons en urgence

Le service Transport Express sur mesure vous assure l'enlèvement et la livraison de vos colis, plans, palettes et hors-gabarit dans les délais les plus courts.



TRANSPORT EXPRESS



Jour-même ou programmé :
horaires garantis



Jusqu' à 1.5 T



France Europe

Pour toute urgence, n'hésitez pas à nous contacter



Contacts

l.bonaventure@bouygues-construction.com

07 60 16 93 10

j.imboden@bouygues-construction.com

07 63 63 56 80



La location

DISTRIPLUS⁺

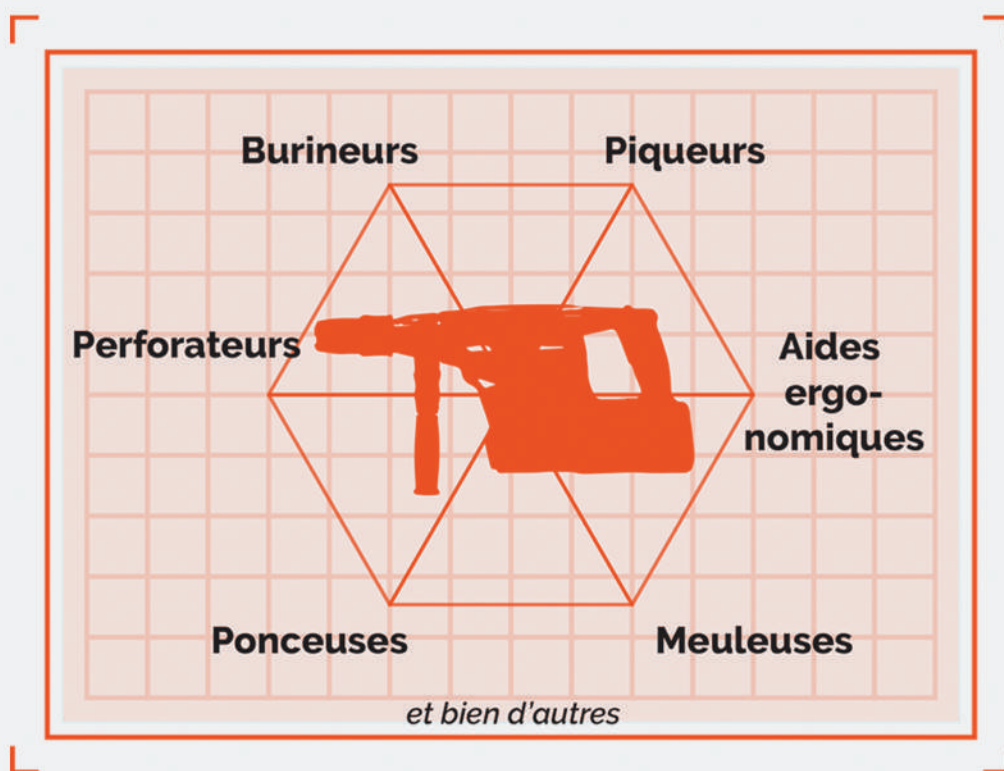

Casse comprise

Le SAV est pris en charge et une machine de remplacement est envoyée au chantier sous 24h. Il n'y a pas de facturation SAV

Vision tarifaire

Avec D+, le chantier a une vision claire et précise sur ce que ça va lui coûter par mois. Ainsi, il maîtrise mieux sa gestion financière en ne louant uniquement des machines qui vont servir

d'électroportatifs

Economie Circulaire

Le service D+ optimise l'utilisation des machines grâce à l'économie circulaire, elles sont réutilisées par plusieurs utilisateurs et utilisatrices, réparées, nettoyées par un ESAT et enfin recyclées lorsqu'elles sont hors-service.

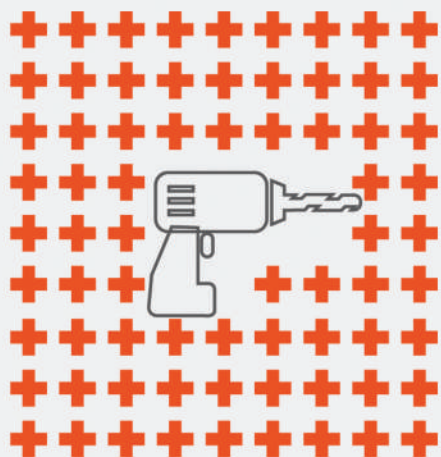

* en cours de déploiement



Machines récentes

Les technologies des électroportatifs évoluant rapidement, nous mettons à disposition des chantiers les machines les plus récentes afin qu'ils puissent profiter des améliorations performance

Avantage perte/vol

Lors d'un vol ou d'une perte, le chantier devra racheter sa machine au prix auquel il l'a achetée. Avec D+, il ne paye que la vétusté en fonction de l'âge de la machine. Au plus cher, il ne paiera que 75 % du prix de la machine neuve

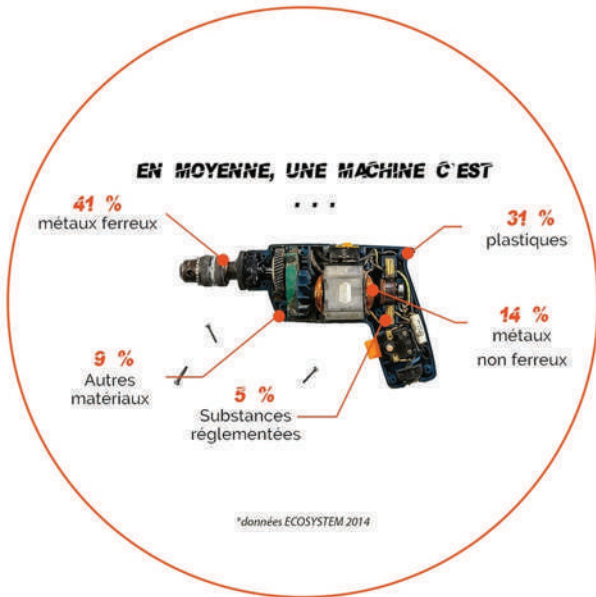

multiplié par



=

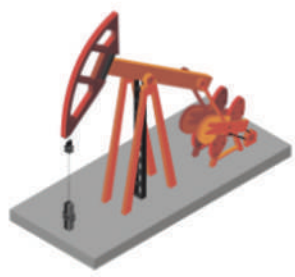

Extraction matières premières

Beaucoup d'énergies et de ressources sont nécessaires à la fabrication d'un grand nombre de machines.



Matériaux à traiter en fin de vie

Ce qui représente un grand nombre de matériaux à traiter et recycler en fin de vie.

DISTRIPUS ET ECONOMIE CIRCULAIRE

Avec Distriplus, l'utilisation de nos machines est optimisée, nous agissons sur l'intégralité du cycle de vie.

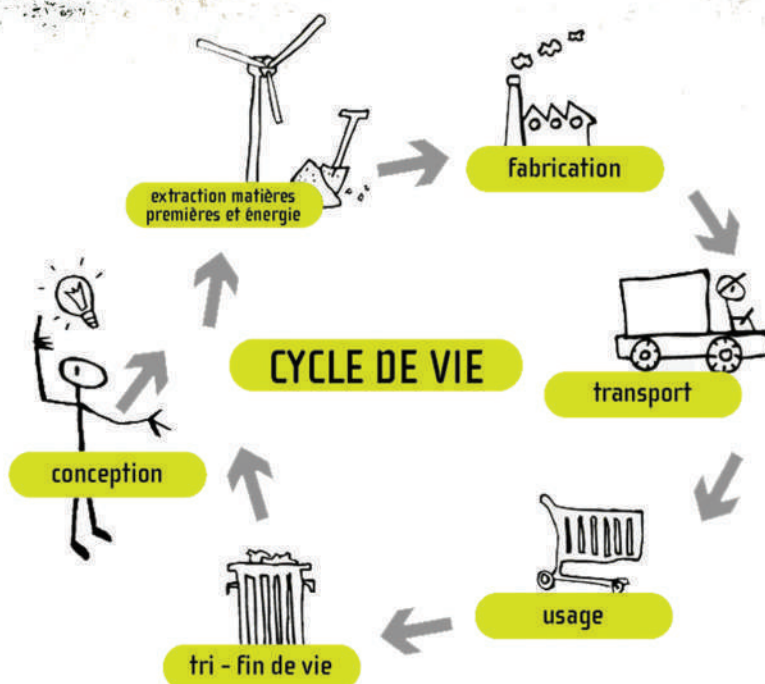

Utiliser plutôt que posséder

Cela permet de réduire la pression sur les ressources naturelles nécessaires pour produire ces machines ainsi que la quantité de déchets produits, en amont au cours du processus de production, et en aval à la fin de vie des produits



Réutiliser

L'optimisation de l'utilisation de nos machines permet de satisfaire les besoins du même nombre d'utilisateurs et utilisatrices, mais en réduisant le nombre de machines en circulation.



Réparer et Recycler

Une fois utilisées et renvoyées chez Distriplus, elles sont révisées dans notre atelier puis renvoyées chez le fabricant si nécessaire.

Avant de retourner dans le cycle de location, elles sont intégralement nettoyées par un ESAT (Les Papillons Blancs) situé à quelques kilomètres de Distrimo.

Une fois hors-service, nous nous assurons de recycler les machines avec



Afin de contribuer à la démarche Économie Circulaire de Bouygues, nous prenons désormais en charge le recyclage des casques et des électroportatifs.

Grâce à ce nouveau programme de recyclage, nous permettons de recycler vos anciens objets et les électroportatifs, de ne pas acheter de nouveaux objets et les électroportatifs, et de contribuer à recycler et d'avoir une économie circulaire.

A l'aide de nos partenaires, nous

Ne jetez plus vos casques et vos électroportatifs !

Process

1

Le chantier stocke les casques et les électroportatifs au fur et à mesure dans des cartons.

2

Le chantier profite d'une livraison, d'un retour ou d'une intervention de BYCN Matériel (et Distrimo en IDF) pour confier au chauffeur les casques et électroportatifs usagés)

Cette logistique inversée permet de contribuer à limiter notre impact carbone.

3

Les casques et électroportatifs sont déposés dans des caisses sur les bases techniques.



Pour les récupérations hors IDF, les casques sont centralisés chez Distrimo à Chilly Mazarin lors de transferts interbases !



Lorsque le quota nécessaire est atteint, nous déclenchons un enlèvement avec notre partenaire ECOSYSTEM.

Une fois les casques arrivés chez Casquethic, des personnes en situation de handicap se chargent de les démanteler. Toutes les parties du casque composées de plastique et de tissu sont recyclables.

Casquethic

ecosystem

Fin de vie

Lorsque le quota de caisses nécessaires est atteint, nous organisons la livraison chez Casquethic à Choisy-le Roi.



- Calotte (matière plastique recyclable)
- Tour de tête (matière plastique recyclable)
- Serre – nuque (matière plastique)
- Jugulaire (matière tissu.)



ues Construction et d'aider les chantiers en ce sens, Bouygues Construction Matériel et Distrimo

électroportatifs sur l'ensemble du territoire français.

e offert aux chantiers, les casques de sécurité collectés seront broyés puis transformés en

atifs seront triés, puis broyés afin d'extraire les différents matériaux/composants dans le but de les

ne nouvelle vie.

de notre flotte logistique et de nos intervenants, nous organisons le retrait des casques et

électroportatifs lors des livraisons, retours et intervention.

Grâce à cette logistique inversée, nous évitons les retours à vide,

et ainsi, nous réduisons l'impact environnemental

de nos livraisons.



la marque de distribution de



SOLUTIONS RECYCLAGE

Avantages

Souplesse et Flexibilité

Distrecycle permet aux chantiers de se débarrasser rapidement de ses casques et électroportatifs sans quantité minimale lors des retours, interventions ou livraisons Bouygues Construction

Engagement social

Grâce à votre démarche, vous contribuez à créer de l'emploi auprès de personnes en situation de handicap.

Pour 100 casques recyclés, Casquethic s'engage à reverser 10 euros à l'association Solidarités Nouvelles pour le Logement

Economique

Bouygues Construction Matériel prend en charge le recyclage.

**Les électroportatifs loués par Distriplus sont systématiquement recyclés par Ecosystem lors de leur mise au rebut.*

Une fois les casques démantelés, les différentes matières sont renvoyées dans une filière de recyclage appropriée. Deux principales étapes sont obligatoires pour recycler : la pré-transformation (tri, broyage, tamisage, densification) et la transformation (extrusion/granulation). La granulation transforme la matière en granulés qui constituent une nouvelle matière première prête à être réutilisée pour fabriquer de nouveaux objets.



EN MOYENNE, UNE MACHINE C'EST

41 %
métaux ferreux

31 %
plastiques

14 %
métaux
non ferreux

9 %
Autres
matériaux

5 %
Substances
réglementées

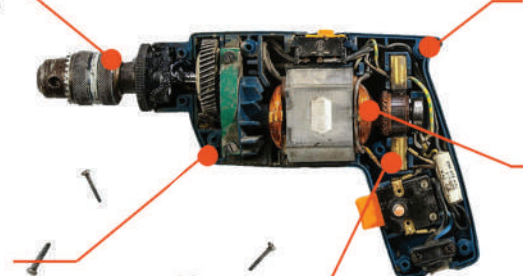

*données ECOSYSTEM 2014

Développement Durable

Nos emballages



Actions et

Conscient.e.s de l'impact environnemental de matières différentes présentes afin de tendre vers de **nouveaux modes de packaging**

DISTRIMO

Film étirable ECOWRAPP

Nos films techniques ECOWRAPP permettent une résistance équivalente à des films standard en divisant par presque 2 leur épaisseur. Nous envoyons donc moins déchets lors de l'envoi de palette

Diviser par 2 l'utilisation du film étirable

Nous testons actuellement le cerclage de la moitié supérieure des palettes afin de réduire de moitié l'utilisation du film étirable

Suppression papier bulles

Nous étudions actuellement avec nos fournisseurs l'utilisation de papier bulles éco responsables ou des alternatives afin de supprimer le papier bulles plastique

Ruban adhésif en KRAFT

Le ruban adhésif en papier KRAFT est respectueux de l'environnement. Son support papier adhésif sans chlore, sans silicone et surtout sans plastique rend ce ruban adhésif kraft totalement recyclable.

Il se déchire facilement à la main. Le ruban adhésif papier

Suppression coussin d'air de calage

Nous testons actuellement une alternative au calage en coussin d'air plastique : le calage papier appelé Paper Grass composé à 50% de gazon et 50% de papier recyclé. Il peut être éliminé sur chantier soit en compostage, soit en jetant l'emballage complet dans la poubelle de tri papier/carton.

Palettes en bois moulées

Nous testons actuellement des palettes fabriquée à partir de 80% de déchets de bois recyclés, moulés et compressés.

Très légère : deux fois plus légère qu'une palette classique pour des coûts d'expédition réduits.

Réutilisation cartons fournisseurs

Nous avons mis en place la réutilisation systématique (dans la mesure du possible) des cartons fournisseurs en bon état pour les expéditions des commandes.

Cartons certifiés

100 % de nos cartons sont fabriqués exclusivement à base de papiers de récupération, ils sont donc 100% recyclés et recyclables. Matières premières référencées par la norme NF EN 643 « liste européenne des sortes standard de papiers et cartons récupérés ».

Certifié FSC – Conseil de soutien de la forêt - (marque de gestion forestière responsable)



bonnes pratiques

nos colis, nous agissons pour réduire le nombre de vers des colis **monomatières éco-responsables et réutilisables.**

FOURNISSEURS

Suppression emballages textiles

Nous collaborons actuellement avec nos fournisseurs de produits textiles (vêtements de travail) pour remplacer voire supprimer l'utilisation de sachets plastiques individuels. Le sac plastique (ou polybag) est aujourd'hui la solution de facilité pour protéger les produits dans l'industrie textile. Il est encore très massivement utilisé, car ses atouts sont nombreux : résistance, souplesse, et transparence pour le passage de douanes. Mais c'est aussi une solution très polluante, à cause de son origine pétrolière et de sa fin de vie souvent non-maitrisée

Car en général, l'emballage que vous recevez quand vous commandez un vêtement, c'est une pochette plastique en PEBD : du polyéthylène basse densité. Comme pour le carton, sa fabrication demande de l'énergie, ce qui émet 1870 kg/tonne d'équivalent CO2 de gaz à effet de serre, beaucoup plus que le carton

Caisses réutilisables
(même si les emballages sont en général **DistriLoop** plus légers).

source : <https://www.loom.fr/pages/emballage>

Suppression blisters fournisseurs

En 2016, nous avons déployé à grande échelle avec nos fabricants DUARIB/Centaure la suppression des emballages des PIRL (blister plastique), elles arrivent dans notre entrepôt uniquement cerclées, ce qui, in fine, réduit la quantité de déchet une fois la PIRL arrivée sur votre chantier.

Depuis cette action, nous sommes en train de collaborer avec nos autres fabricants et sur d'autres typologies de produits afin de supprimer les blisters inutiles

Caisses réutilisables DistriLoop

Nous étudions avec certains fournisseurs la possibilité d'utiliser des caisses réutilisables pour des produits potentiellement compatibles à la rotation Fournisseur/Distrimo.

Nous supprimerons ainsi une certaine quantité de cartons arrivant en amont de la chaîne DISTRIMO.



Notre processus Innovation

bISTRIMO
La marque de distribution de 

**BOUYGUES
CONSTRUCTION**
MATÉRIEL

Idée

- Demande
- Validation
- Orientation



Une idée pour améliorer nos produits ?
Une remontée concernant un de nos produits ou une situation problématique ?

Participez au développement des produits de demain et optez pour des tests terrains !



- Étude de conception
- Validation critères :
 - ergonomie
 - santé/sécurité
 - compétitivité
 - environnement

Étude

Prototype

Fabrication de 2 prototypes pour tests chantiers et Retour d'EXpériences



Fabrication de 10 préséries pour tests chantiers et Retour d'EXpériences

Présérie

Déploiement

Matériel validé issu de l'innovation et de l'amélioration matériel = Nouveau standard d'entreprise



PROVINCE & EUROPE



GUILLAUME BONNET
Responsable site Tourville La
Rivière
06 99 04 80 83
g.bonnet@bouygues-construction.com

ÉQUIPE COMMERCIALE



STÉPHANE BLANCHET
Responsable commercial
Province
Spécialité HILTI / SPIT
02 78 62 53 95 / 06 68 05 71 64
s.blanchet@bouygues-construction.com



FANNY SABLE
Technico-commerciale Province
Spécialité paquetage et prestations
marquage
02 78 62 53 59
f.sable@bouygues-construction.com



MICKAËL ADLAOUI
Technico-commercial Province
Spécialité HILTI / SPIT, technique et
mobilier
02 78 62 58 79
m.adlaoui@bouygues-construction.com



VINCENT PETIT
Technico-commercial Province
02 78 62 58 87
v.petit@bouygues-construction.com



HÉLÈNE PACOUIL
Responsable Distrimo
06 61 65 60 42
h.pacouil@bouygues-construction.com

RÉFÉRENTS PRODUITS

EPI



NADINE AUBRY
Référente EPI & BYES
06 98 29 15 45
n.aubry@bouygues-construction.com

ÉLECTROPORTATIF



VINCENT POUILLARD
Référent électroportatif
06 50 37 96 13
v.poullard@bouygues-construction.com

INNOVATION



THOMAS BOBIN
Chargé d'Innovation &
Marketing
06 98 16 95 93
t.bobin@bouygues-construction.com



1 contact unique
02 78 620 620

servicecommercial.distrimo@bouygues-construction.com

DISTRIMO 2 boulevard Gabriel Péri 76 410 TOURVILLE LA RIVIERE
DISTRIMO 30 route de Longjumeau 91 380 CHILLY-MAZARIN

IDF & INTERNATIONAL



DAVID DIAS
Responsable site Chilly-Mazarin
06 69 98 48 69
d.dias2@bouygues-construction.com

ÉQUIPE COMMERCIALE



AUGUSTIN GALLOT
Responsable commercial
sédentaire IDF & Pôle export
01 80 61 39 43 // 06 68 74 08 33
l.gallot@bouygues-construction.com



SONIA GUEUDIN
Technico-commerciale IDF
01 80 61 41 97
s.gueudin@bouygues-construction.com



ISABELLE MORILLE
Technico-commerciale IDF
01 80 61 40 91
i.morille@bouygues-construction.com



FRÉDÉRIC DA ROCHA
Technico-commercial IDF
01 80 61 41 78
f.darocha@bouygues-construction.com



NATHALIE MATOS
Technico-commerciale
international
07 63 64 15 92
n.matos@bouygues-construction.com



SÉBASTIEN GERRAND
Responsable commercial itinérant
clients BYBAT / BYES / COLAS
06 50 35 43 58
s.gerrand@bouygues-construction.com



GRÉGORY MARTINS
Technico-commercial Itinérant
Grand Paris TP / COLAS
06 98 98 30 55
g.martins@bouygues-construction.com

COMMANDE / SERVICE SPÉCIFIQUE

TOPSITE & WIZOM



CATHERINE DESPREZ
Assistante Distrimo TLR
Technico-commerciale Wizom & Topsite
02.78.62.58.78
c.desprez@bouygues-construction.com

DISTRIPLUS



ALEXANDRA OWCZARZAK
Technico-commerciale Distriplus
07 64 00 22 71
a.owczarzak@bouygues-construction.com

S.A.V



LOÏC FAUCHER
Interlocuteur SAV Electroportatif
02 78 62 58 50
loic.faucher@bouygues-construction.com

Conditions

Distrimo- Mai 2021



Nos ventes sont soumises aux présentes conditions particulières et générales de vente qui prévalent sur toutes conditions d'achats, sauf dérogation formelle et express de notre part.

1 - Nos conditions particulières de vente

Nos prix sont hors taxes, toutes taxes en vigueur applicables en sus y compris DEEE et mobilier (eco-taxe).

Nos prix sont applicables selon les conditions présentes sur Pablo et Hermès, sur base du tarif en vigueur le jour de la livraison, et susceptibles d'être modifiés en fonction des conditions économiques du marché.

En France, nos prix sont franco chantier, pour toutes commandes sur catalogue, dans les conditions normales de délais ci-dessous, sauf cas particuliers.

Pour toutes commandes de matériel hors catalogue, le transport est en sus.

Hors France et pour les sociétés non référencées par contrat cadre, le transport est à la charge de l'Acheteur.

2 - Nos conditions générales de vente

➔ Documentation et publicité

Les renseignements de toute nature figurant sur nos documentations, catalogues, et publicités notamment, n'ont qu'une valeur indicative. Photos non contractuelles.

➔ Commande

Toute commande doit être confirmée par un bon de commande ou d'approvisionnement émanant de l'acheteur, envoyée à l'un de 2 sites logistique.

Toute commande est acceptée en considération de la situation juridique, financière et matériel de l'acheteur. Il en résulte que le vendeur sera fondé à exiger des garanties de paiement ou à résilier le contrat sans indemnité quelle qu'elle soit, si la dite situation venait à être modifiée entre la commande et la livraison.

➔ Délais

Nos délais ne sont donnés qu'à titre indicatif, et ne peuvent donner lieu à aucune pénalité de retard. Pour toutes commandes de produits tenus en stock et passées avant 12 heures, la livraison France se fera au maximum dans les 3 jours ouvrés suivants.

En cas de livraison immédiate demandée par le chantier, le port express sera facturé en sus.

Les retards dus à des cas de force majeure et ceux provenant de retard de nos fournisseurs ainsi que toutes autres circonstances échappant à notre contrôle, repoussent d'autant les délais de livraison indiqués, sans possibilité à l'Acheteur de déposer une quelconque réclamation.

générales de vente

→ Livraison expédition

Quel que soit le mode d'expédition de notre choix, nos marchandises voyagent aux risques et périls du destinataire, même lors d'expéditions en franco. Il lui appartient de contrôler les marchandises à l'arrivée et pour toute avarie, manque ou autre cause que ce soit, de faire les réserves nécessaires auprès du transporteur par lettre recommandée avec accusé de réception, dans les 3 jours et de nous en transmettre une copie.

Toute livraison est accompagnée d'un bordereau de livraison en 2 exemplaires :

- * 1 exemplaire à retourner signé au vendeur,
- * 1 exemplaire restant à l'acheteur.

→ Réserve de propriété

En application de la loi N° 80.335, du 12/05/1980, le vendeur se réserve la propriété des marchandises livrées et désignées sur les factures jusqu'au paiement intégral de leur prix, en principal et intérêts.

→ Garantie / Echange

"DISTRIMO garantit le produit livré contre les défauts ou vices cachés, dans les conditions légales ainsi qu'aux conditions de garanties fournies par son conducteur. La garantie est limitée au remplacement gratuit des pièces reconnues défectueuses, à l'exclusion des piles ou batteries électriques et des dégats occasionnés par la foudre, l'incendie ou explosion d'engins voisins à nos produits. Toutes utilisations anormales ou non conformes aux prescriptions du conducteur, toutes transformations ou modifications d'une manière quelconque des produits, entraîneront la cessation de garantie. Il en sera de même si les marques ou les numéros de séries sont enlevés et modifiés. Le retour des produits défectueux ne dispense pas du règlement à l'échéance prévue et ne pourra donner droit à une indemnité pour quelque cause que ce soit. Toute suspension dans le règlement donnera droit à des dommages et intérêts se rapportant au préjudice subi. DISTRIMO peut assurer un échange de produit sous 30 jours maxi. Au delà de ce délai, DISTRIMO ne s'engage pas sur la reprise des produits."

→ Paiement

Sauf stipulation contraire, toutes nos factures sont payables :

- * Comptant à réception de facture.
- * A terme à réception de facture après ouverture de compte, selon accord écrit. Tout retard de paiement de nos factures, après mise en demeure restée infructueuse, entraînera de plein droit des intérêts moratoires calculés sur la base du taux d'escompte de la banque de France, majorée 3% sans préjudice des dommages et intérêts qui pourraient être réclamés à la partie défaillante.

→ Clause résolutoire de plein droit

En cas d'inexécution des ses obligations par une partie, le présent contrat sera résolu de plein droit au profit de l'autre partie, sans préjudice des dommages et intérêts qui pourraient être réclamés à la partie défaillante. La résolution prendra effet 8 jours après l'envoi d'une mise en demeure restée infructueuse.

→ Juridiction

En cas de contestations ou de litiges, le tribunal de commerce de Rouen est seul compétent, quelles que soient les conditions de vente ou les modes de paiement acceptés même en cas d'appel en garantie ou de pluralité de défendeurs. L'émission de traite ne constitue ni novation, ni dérogation à cette clause attributive de juridiction.

NOTRE SITE WEB



**Flashez-moi pour
découvrir le site**



**Consultez nos produits,
leurs disponibilité
et tarifs**

**Utilisez nos aides au choix
interactives**

(Pirl/Outil d'accès,
électroportatifs,
aides ergonomiques)

**Retrouvez nos fiches
techniques et FDS**

**Découvrez notre histoire
et nos services**

Besoin d'aide ? support-site-distrimo@bouygues-construction.com